

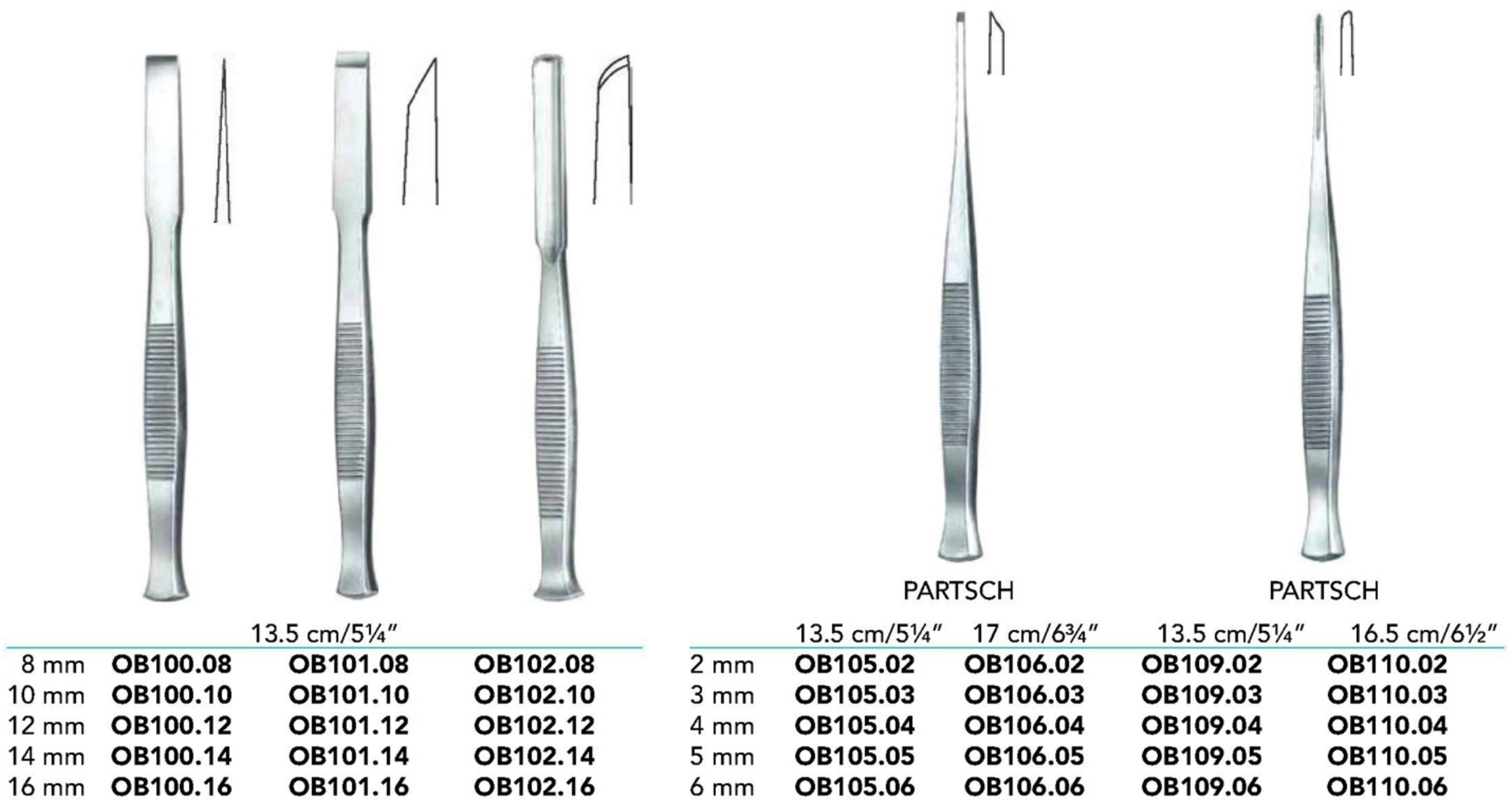

## Bone Surgery (Bone Chisels, Gouges, Osteotomes)

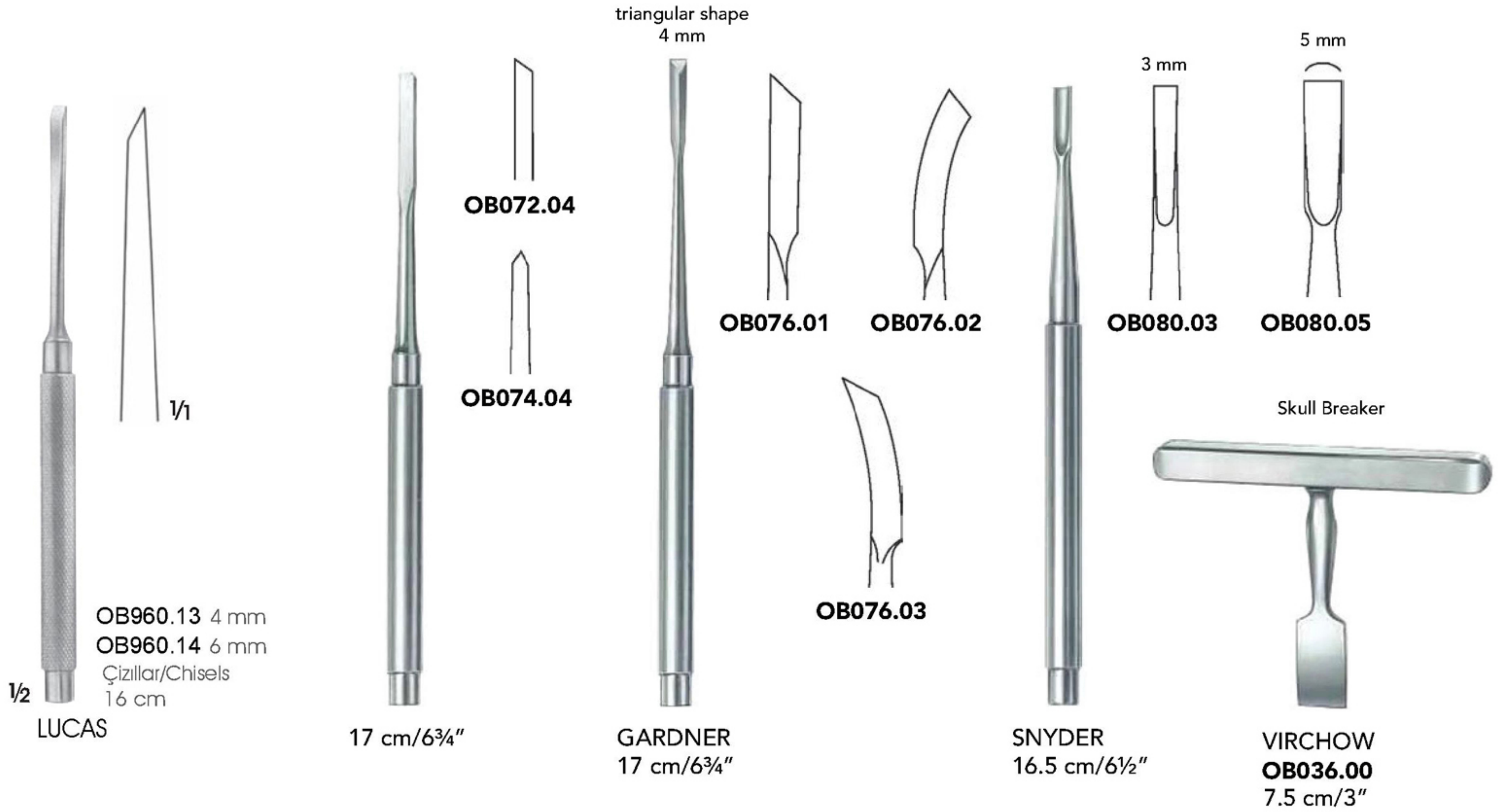





## Bone Surgery (Bone Chisels, Gouges, Osteotomes)



**ALEXANDER**  
17.5 cm/7"

4 mm	<b>OB118.04</b>	<b>OB119.04</b>
6 mm	<b>OB118.06</b>	<b>OB119.06</b>
8 mm	<b>OB118.08</b>	<b>OB119.08</b>
10 mm	<b>OB118.10</b>	<b>OB119.10</b>
12 mm	<b>OB118.12</b>	<b>OB119.12</b>
14 mm	<b>OB118.14</b>	<b>OB119.14</b>

**STILLE**

<b>OB960.48</b>	10 mm
<b>OB960.49</b>	12 mm
<b>OB960.50</b>	15 mm
<b>OB960.51</b>	20 mm
<b>OB960.52</b>	25 mm
	20.5 cm

**STILLE**  
20.5 cm/8"

8 mm	<b>OB124.08</b>	<b>OB125.10</b>	<b>OB127.10</b>
10 mm	<b>OB123.10</b>	<b>OB124.10</b>	<b>OB125.12</b>
12 mm	<b>OB123.12</b>	<b>OB124.12</b>	<b>OB125.15</b>
15 mm	<b>OB123.15</b>	<b>OB124.15</b>	<b>OB125.20</b>
20 mm	<b>OB123.20</b>	<b>OB124.20</b>	<b>OB125.25</b>
25 mm	<b>OB123.25</b>	<b>OB124.25</b>	<b>OB127.25</b>

**LAMBOTTE-MINI**  
12.5 cm/5"

2 mm	<b>OB136.02</b>
3 mm	<b>OB136.03</b>
4 mm	<b>OB136.04</b>
6 mm	<b>OB136.06</b>
8 mm	<b>OB136.08</b>
10 mm	<b>OB136.10</b>
12 mm	<b>OB136.12</b>
15 mm	<b>OB136.15</b>

**LAMBOTTE-MINI**  
17.5 cm/7"

3 mm	<b>OB136.53</b>
4 mm	<b>OB136.54</b>
6 mm	<b>OB136.56</b>
8 mm	<b>OB136.58</b>
10 mm	<b>OB136.60</b>
12 mm	<b>OB136.62</b>
15 mm	<b>OB136.65</b>

**LAMBOTTE**  
24 cm/9½"

4 mm	<b>OB138.04</b>
6 mm	<b>OB138.06</b>
8 mm	<b>OB138.08</b>
10 mm	<b>OB138.10</b>
13 mm	<b>OB138.13</b>
15 mm	<b>OB138.15</b>
18 mm	<b>OB138.18</b>
20 mm	<b>OB138.20</b>
25 mm	<b>OB138.25</b>
30 mm	<b>OB138.30</b>
38 mm	<b>OB138.38</b>
44 mm	<b>OB138.44</b>
50 mm	<b>OB138.50</b>

**LAMBOTTE**  
24 cm/9½"

4 mm	<b>OB139.04</b>
6 mm	<b>OB139.06</b>
8 mm	<b>OB139.08</b>
10 mm	<b>OB139.10</b>
13 mm	<b>OB139.13</b>
15 mm	<b>OB139.15</b>
18 mm	<b>OB139.18</b>
20 mm	<b>OB139.20</b>
25 mm	<b>OB139.25</b>
30 mm	<b>OB139.30</b>
38 mm	<b>OB139.38</b>
44 mm	<b>OB139.44</b>
50 mm	<b>OB139.50</b>





## Bone Surgery (Bone Chisels, Gouges, Osteotomes)

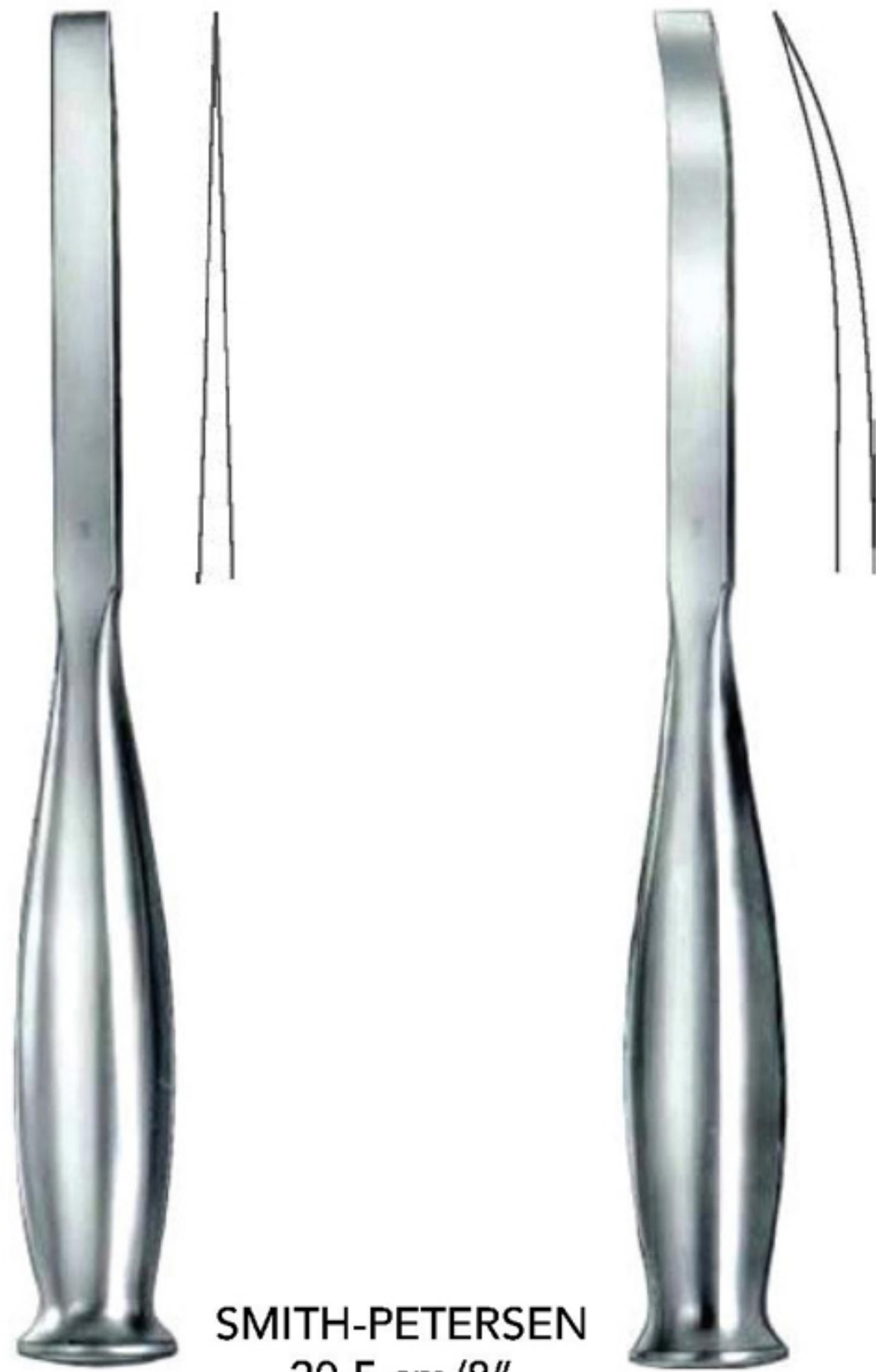

**SMITH-PETERSEN**  
20.5 cm/8"

6 mm	<b>OB154.06</b>	<b>OB155.06</b>
9 mm	<b>OB154.09</b>	<b>OB155.09</b>
13 mm	<b>OB154.13</b>	<b>OB155.13</b>
16 mm	<b>OB154.16</b>	<b>OB155.16</b>
19 mm	<b>OB154.19</b>	<b>OB155.19</b>
25 mm	<b>OB154.25</b>	<b>OB155.25</b>
32 mm	<b>OB154.32</b>	<b>OB155.32</b>

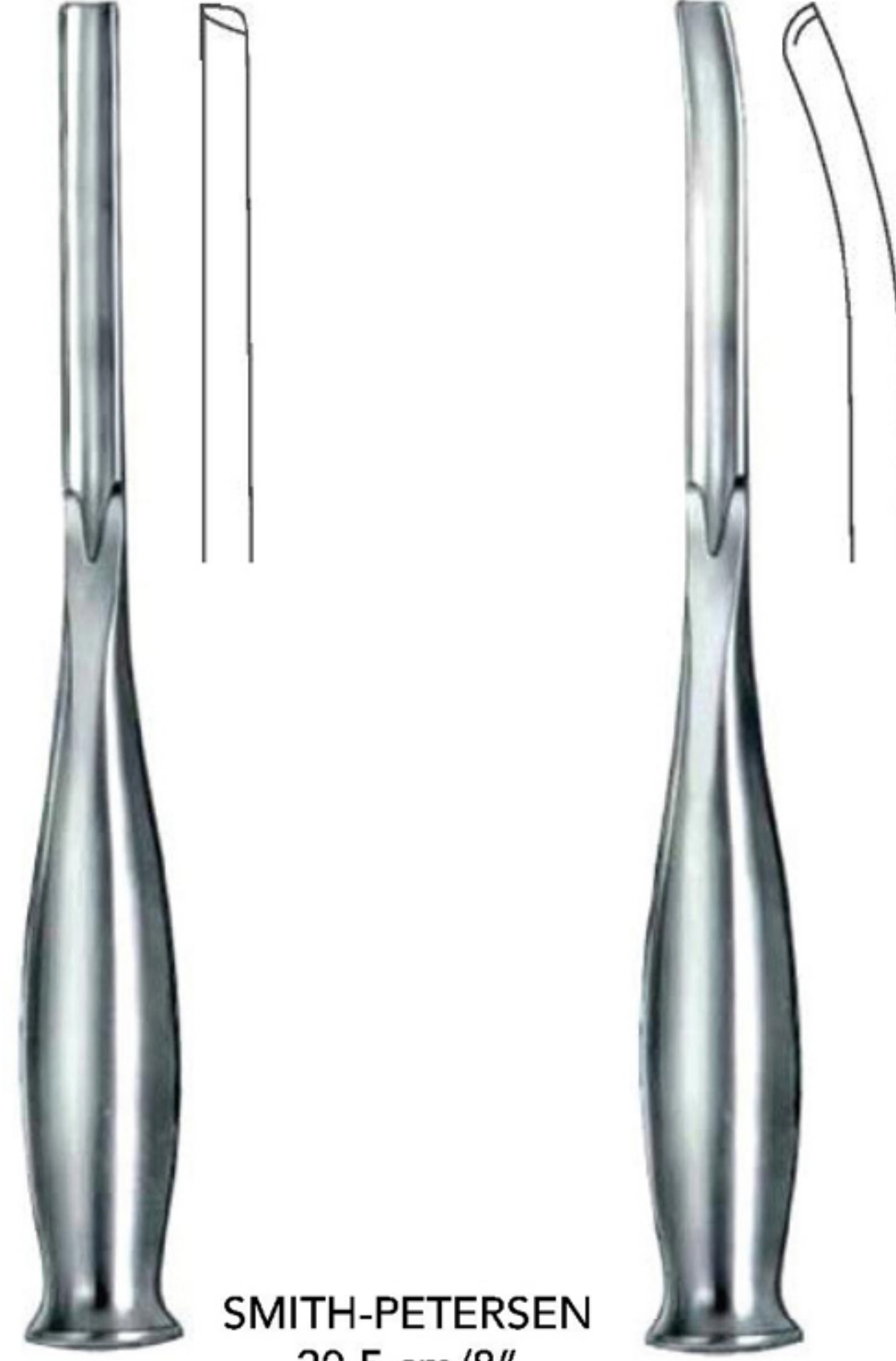

**SMITH-PETERSEN**  
20.5 cm/8"

9 mm	<b>OB156.09</b>	<b>OB157.09</b>
14 mm	<b>OB156.16</b>	<b>OB157.16</b>
19 mm	<b>OB156.19</b>	<b>OB157.19</b>
25 mm	<b>OB156.25</b>	<b>OB157.25</b>



**HOKE**  
17 cm/6¾"

3 mm	<b>OB162.03</b>
5 mm	<b>OB162.05</b>
6 mm	<b>OB162.06</b>
8 mm	<b>OB162.08</b>
9 mm	<b>OB162.09</b>

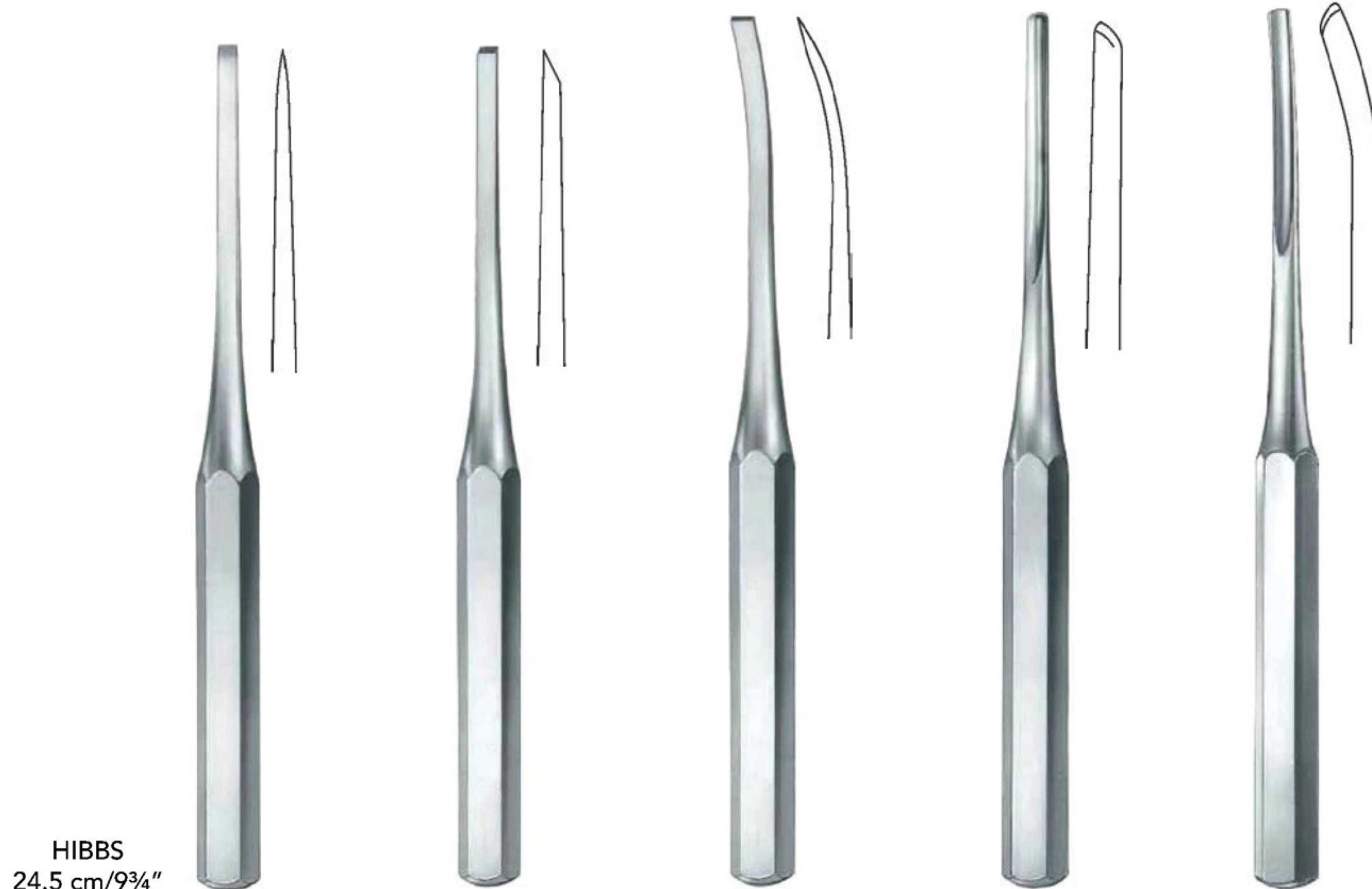

**HIBBS**  
24.5 cm/9¾"

6 mm	<b>OB170.06</b>	<b>OB172.06</b>	<b>OB173.06</b>	<b>OB176.06</b>	<b>OB177.06</b>
13 mm	<b>OB170.13</b>	<b>OB172.13</b>	<b>OB173.13</b>	<b>OB176.13</b>	<b>OB177.13</b>
19 mm	<b>OB170.19</b>	<b>OB172.19</b>	<b>OB173.19</b>	<b>OB176.19</b>	<b>OB177.19</b>
25 mm	<b>OB170.25</b>	<b>OB172.25</b>	<b>OB173.25</b>	<b>OB176.25</b>	<b>OB177.25</b>
32 mm	<b>OB170.32</b>	<b>OB172.32</b>	<b>OB173.32</b>	<b>OB176.32</b>	<b>OB177.32</b>





## Bone Surgery (Osteotomes, Gouges)

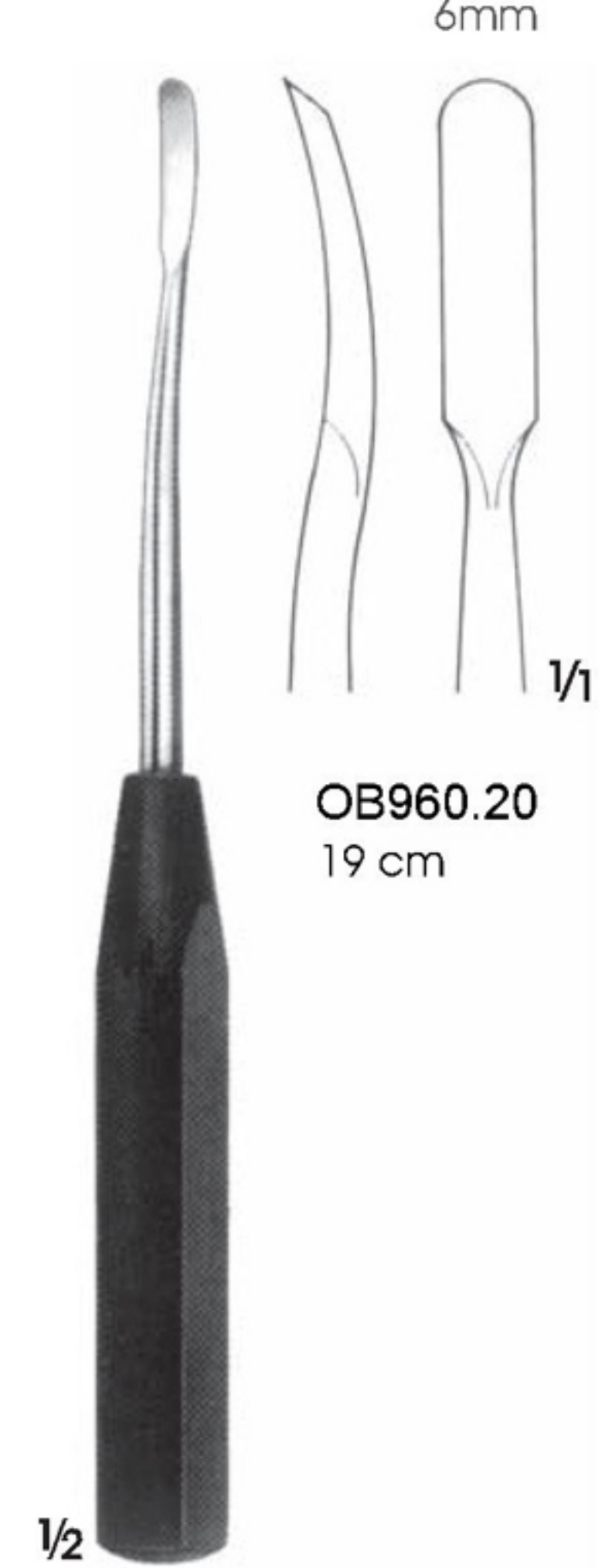

**ZIELKE**  
23 cm/9"  
5.5 mm **OB112.05**  
9 mm **OB112.09**



**LEXER**  
24.5 cm/9 3/4"  
5 mm **OB131.05**  
10 mm **OB131.10**  
15 mm **OB131.15**



**LEXER**  
24.5 cm/9 3/4"  
5 mm **OB131.55**  
10 mm **OB131.60**  
15 mm **OB131.65**



**COBB**  
28 cm/11"

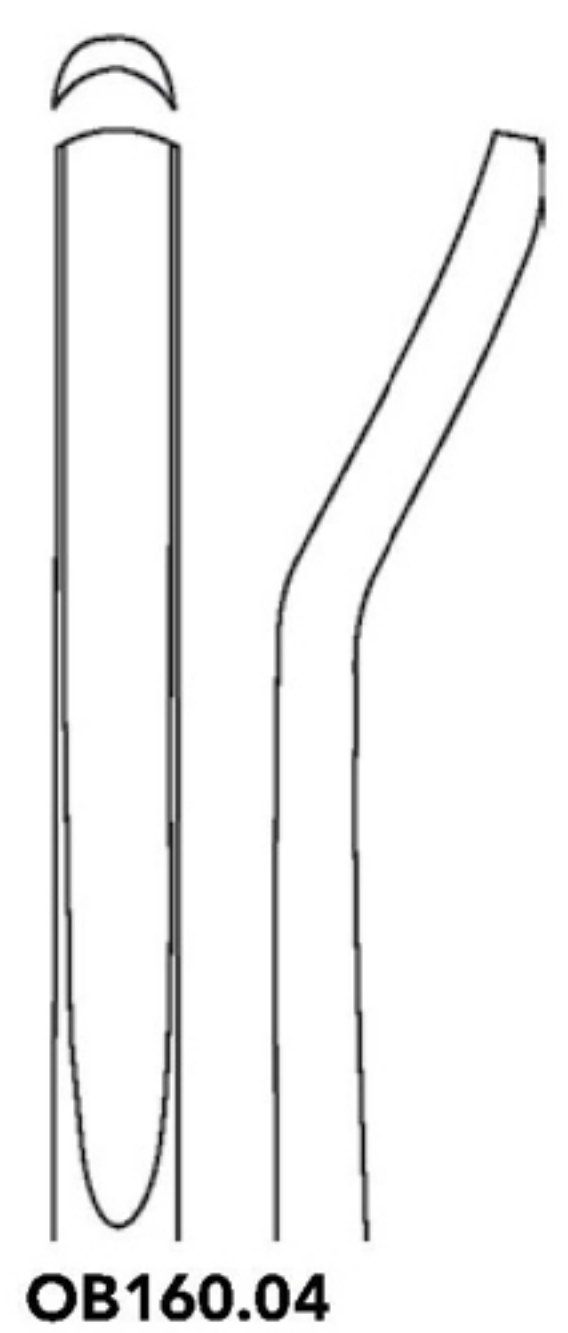
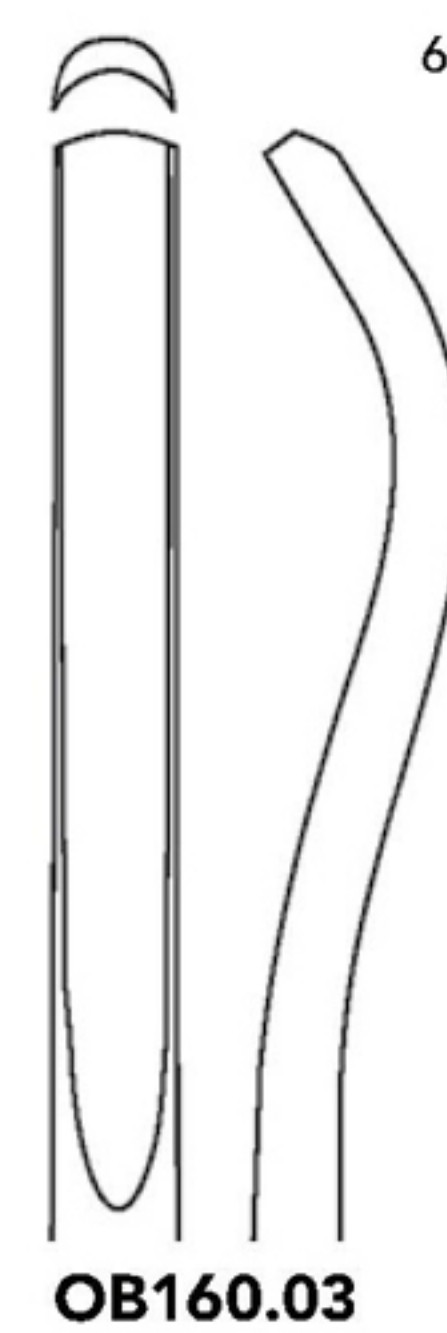
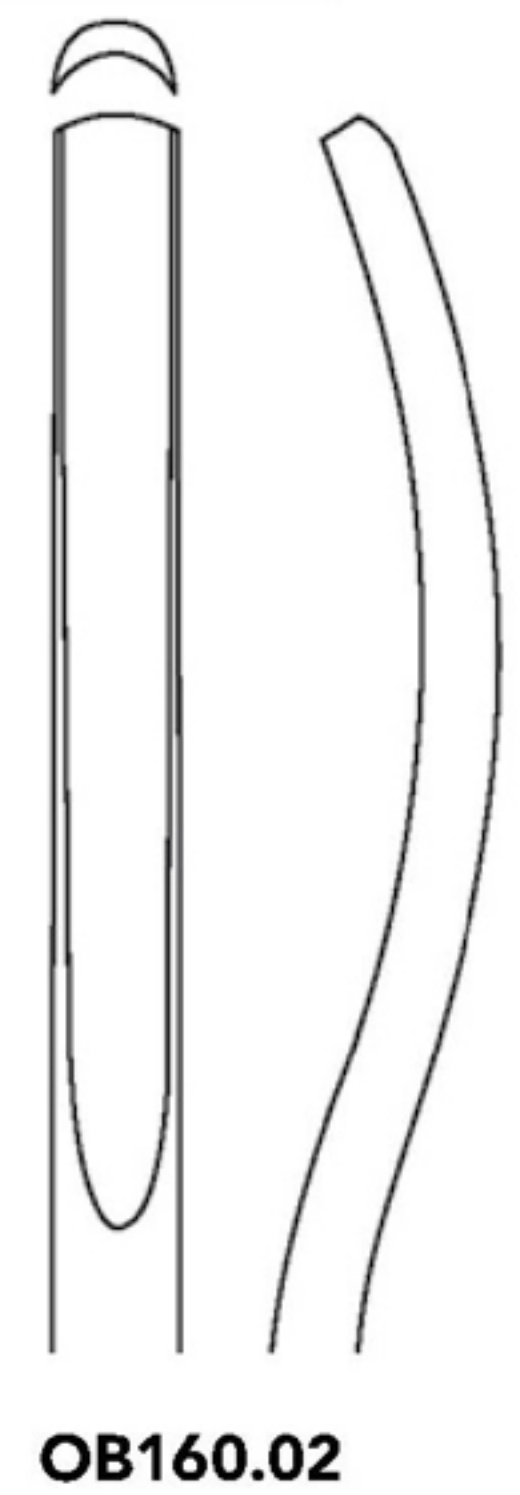





## Bone Surgery (Osteotomes, Gouges, Bone Curettes)



**LEXER**  
22 cm/8¾"

- 5 mm **OB134.05**
- 7 mm **OB134.07**
- 10 mm **OB134.10**
- 15 mm **OB134.15**
- 20 mm **OB134.25**
- 25 mm **OB134.20**
- 30 mm **OB134.30**



**LEXER**  
22 cm/8¾"

- 5 mm **OB135.05**
- 7 mm **OB135.07**
- 10 mm **OB135.10**
- 15 mm **OB135.15**
- 20 mm **OB135.25**
- 25 mm **OB135.20**
- 30 mm **OB135.30**



**LEXER-MINI**  
18 cm/7"

- 4 mm **OB132.04**
- 6 mm **OB132.06**
- 8 mm **OB132.08**
- 10 mm **OB132.10**
- 12 mm **OB132.12**



**LEXER-MINI**  
18 cm/7"

- 4 mm **OB133.04**
- 8 mm **OB133.06**
- 8 mm **OB133.08**
- 10 mm **OB133.10**
- 12 mm **OB133.12**



**VOLKMANN**

- |      |                 |                 |
|------|-----------------|-----------------|
| Fig. | 17 cm/7"        | 27 cm/10¾"      |
| 0000 | <b>OB280.40</b> |                 |
| 000  | <b>OB280.30</b> |                 |
| 00   | <b>OB280.20</b> |                 |
| 0    | <b>OB280.10</b> | <b>OB282.10</b> |
| 1    | <b>OB280.01</b> | <b>OB282.01</b> |
| 2    | <b>OB280.02</b> | <b>OB282.02</b> |
| 3    | <b>OB280.03</b> | <b>OB282.03</b> |
| 4    | <b>OB280.04</b> | <b>OB282.04</b> |
| 5    | <b>OB280.05</b> |                 |
| 6    | <b>OB280.06</b> |                 |



**CASPER**

- 22 cm/8¾"
- Ø 3 mm **OB197.03**
  - Ø 5 mm **OB197.05**
  - Ø 7 mm **OB197.07**
  - Ø 8 mm **OB197.08**
  - Ø 9 mm **OB197.09**



20 cm/8"

- Ø 12 mm **OB199.12**
- Ø 14 mm **OB199.14**
- Ø 16 mm **OB199.16**



**PASSOW**  
**OB960.81-82**  
12 cm

- **OB960.81**  
3.5 mm
- **OB960.82**  
2.5 mm



15.5 cm/6"

- Ø 2 mm **OB198.02**
- Ø 3 mm **OB198.03**
- Ø 4 mm **OB198.04**
- Ø 5 mm **OB198.05**
- Ø 6 mm **OB198.06**
- Ø 7 mm **OB198.06**
- Ø 8 mm **OB198.08**
- Ø 9 mm **OB198.08**
- Ø 10 mm **OB198.10**





## Bone Surgery (Mallets)



**WILLIGER**  
24 cm/9½"

- Ø 26 mm 275g **OB200.01**
- Ø 28 mm 320g **OB200.02**
- Ø 30 mm 340g **OB200.03**



**DOYEN**  
20.5 cm/8¼"

- Ø 25 mm 120g **OB204.01**
- Ø 30 mm 170g **OB204.02**
- Ø 35 mm 260g **OB204.03**



220g  
Ø 30 mm

**COLLIN**  
**OB208.20**  
20 cm/7¾"



**LUCAE**  
19.5 cm/7¾"

- Ø 19 mm 230g **OB214.01**
- Ø 25 mm 260g **OB214.02**



30C  
Ø 30 mm

**COTTLE**  
**OB215.19**  
19 cm/7½"



Ø 40 mm  
520 gr

1/2  
**OMBREDANNE**  
**OB960.56**  
24 cm



140g  
Ø 20 mm

**WILLIGER**  
**OB216.01**  
16.5 cm/6½"



450g  
Ø 30 mm

**OB221.00**  
Spare facing pair

**MEAD**  
**OB220.17**  
19 cm/7½"



175g  
Ø 27 mm

**PARTSCH**  
**OB224.18**  
19 cm/7½"



Ø 27 mm

1/2  
**HAJEK**  
**OB960.21**  
135 gr.  
22 cm



Ø 22

1/2  
**OB960.22**  
155 gr  
19 cm



Ø 30 mm

Ø 42 mm  
285 gr

1/2  
**OB960.43**  
24 cm





## Bone Surgery (Mallets)







## Bone Surgery (Bone Curettes)



**SCHEDÉ**

Fig.	17 cm/7"
000	<b>OB300.30</b>
00	<b>OB320.20</b>
0	<b>OB300.10</b>
1	<b>OB301.01</b>
2	<b>OB301.02</b>
3	<b>OB301.03</b>
4	<b>OB301.04</b>



**VOLKMANN**

Fig.	17 cm/7"
0000	<b>OB304.40</b>
000	<b>OB304.30</b>
00	<b>OB304.20</b>
0	<b>OB304.10</b>
1	<b>OB305.01</b>
2	<b>OB305.02</b>
3	<b>OB305.03</b>
4	<b>OB305.04</b>
5	<b>OB305.05</b>
6	<b>OB305.06</b>



**BRUNS**

Fig.	17 cm/7"
0000	<b>OB308.40</b>
000	<b>OB308.30</b>
00	<b>OB308.20</b>
0	<b>OB308.10</b>
1	<b>OB339.01</b>
2	<b>OB339.02</b>
3	<b>OB339.03</b>
4	<b>OB339.04</b>
5	<b>OB339.05</b>
6	<b>OB339.06</b>



**BRUNS**

Fig.	17 cm/7"
000	<b>OB960.65</b>
00	<b>OB960.66</b>
0	<b>OB960.67</b>
1	<b>OB960.68</b>
2	<b>OB960.69</b>
3	<b>OB960.70</b>
4	<b>OB960.71</b>



**SPRATT**

Fig.	20 cm
0000	<b>OB312.40</b>
000	<b>OB312.30</b>
00	<b>OB312.20</b>
0	<b>OB312.10</b>
1	<b>OB313.01</b>
2	<b>OB313.02</b>
3	<b>OB313.03</b>
4	<b>OB313.04</b>
5	<b>OB313.05</b>



**SPRATT**

Fig.	20 cm
0000	<b>OB960.72</b>
000	<b>OB960.73</b>
00	<b>OB960.74</b>
0	<b>OB960.75</b>
1	<b>OB960.76</b>
2	<b>OB960.77</b>
3	<b>OB960.78</b>
4	<b>OB960.79</b>
5	<b>OB960.80</b>



**DAUBENSPECK**

Fig.	17 cm/7"
0000	<b>OB306.40</b>
000	<b>OB306.30</b>
00	<b>OB306.20</b>
0	<b>OB306.10</b>



**MODELL USA**

Fig.	16.5 cm/6½"
1	<b>OB.344.01</b>
2	<b>OB.344.02</b>
3	<b>OB.344.03</b>
4	<b>OB.344.04</b>
5	<b>OB.344.05</b>
6	<b>OB.344.06</b>



**MODELL USA**

Fig.	16.5 cm/6½"
1	<b>OB.345.01</b>
2	<b>OB.345.02</b>
3	<b>OB.345.03</b>
4	<b>OB.345.04</b>
5	<b>OB.345.05</b>
6	<b>OB.345.06</b>



**MODELL USA**

Fig.	16.5 cm/6½"
1	<b>OB.347.01</b>
2	<b>OB.347.02</b>
3	<b>OB.347.03</b>
4	<b>OB.347.04</b>
5	<b>OB.347.05</b>
6	<b>OB.347.06</b>

Fig.	25 cm/9¾"
1	<b>OB.350.01</b>
2	<b>OB.350.02</b>
3	<b>OB.350.03</b>







## Bone Surgery (Bone Currettes)



15 cm/6"

Fig. WILLIGER  
00/00 **OB359.00**  
0/0 **OB359.10**  
1/1 **OB359.12**



JACOBSEN  
**OB351.14**  
14 cm/5½"



VOLKMANN  
12.5 cm/4¾" **OB352.13**  
14.5 cm/5¾" **OB352.14**  
17.0 cm/6¾" **OB352.17**



VOLKMANN  
13 cm/5" **OB354.13**  
16 cm/6¼" **OB354.16**  
20 cm/8" **OB354.20**



14 cm/5½"  
Fig. WILLIGER  
00/0 **OB358.00**  
0/1 **OB358.01**  
1/2 **OB358.12**



MOLT  
**OB395.24**  
19 cm/7½"



BUSHE  
25 cm/9¾"  
3 mm **OB348.03**  
4 mm **OB348.04**  
5 mm **OB348.05**



**OB356.21**  
21 cm/8¼"



SCOVILLE  
25 cm/9¾"  
**OB336.25**  
**OB337.25**  
**OB339.25**



SIMON  
22.5 cm/8¾"  
Fig. **OB340.01**  
1 **OB340.02**  
2 **OB340.03**  
3 **OB340.04**  
4 **OB340.05**  
5 **OB340.06**  
6



Fig. 25 cm/9¾"  
000 **OB342.30**  
00 **OB342.20**  
0 **OB342.10**  
1 **OB342.01**



BRUNS  
23 cm/9"  
Fig. **OB334.30**  
000 **OB334.20**  
00 **OB334.10**  
0 **OB335.01**  
1 **OB335.02**  
2 **OB335.03**  
3 **OB335.04**  
4 **OB335.05**  
5 **OB335.06**  
6





## Bone Surgery (Periosteal Elevators)



**MOLT**  
17 cm/7"



**OB395.01**  
Fig. 1

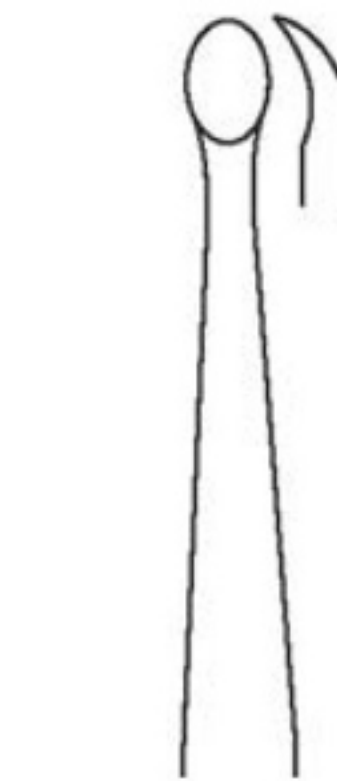

**OB395.02**  
Fig. 2

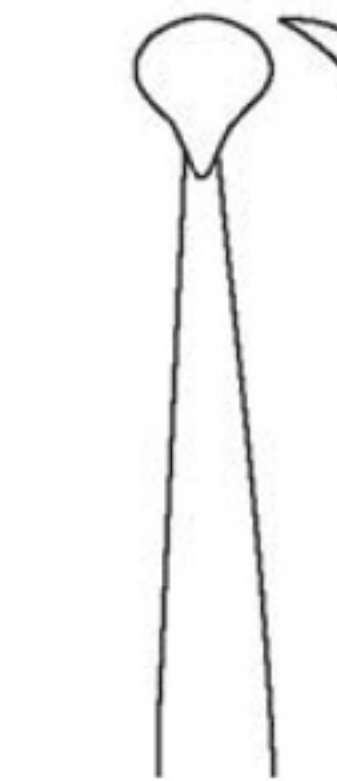

**OB395.03**  
Fig. 3



**OB395.04**  
Fig. 4



**OB395.05**  
Fig. 5



**MARTIN-LANGENBECK**

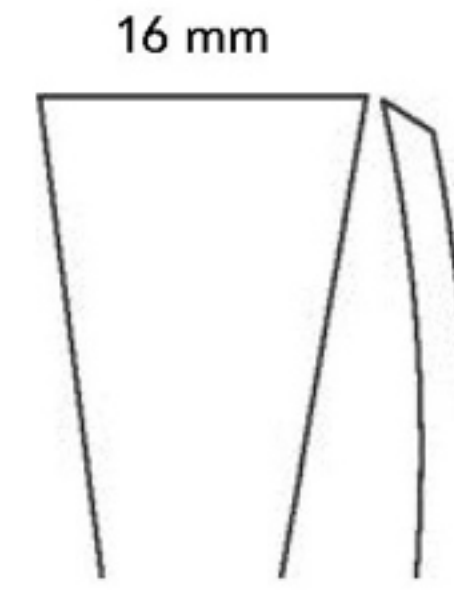

**OB400.01**  
19 cm/7½"

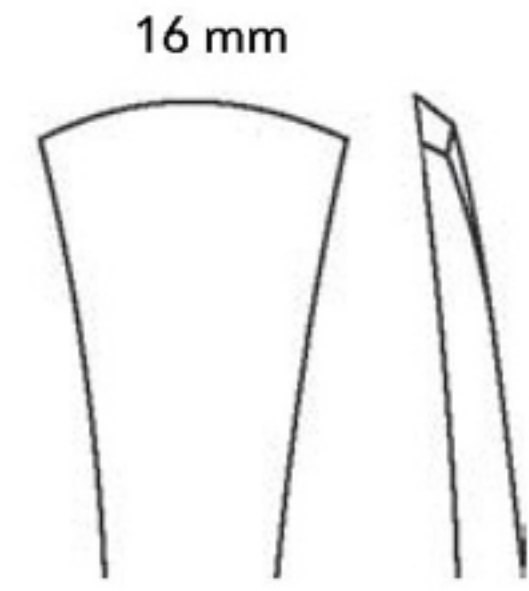

**OB400.02**  
20 cm/8"

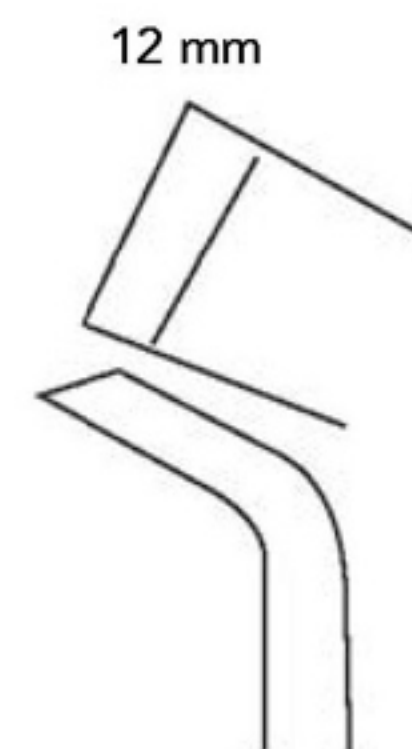

**OB400.03**  
19 cm/7½"

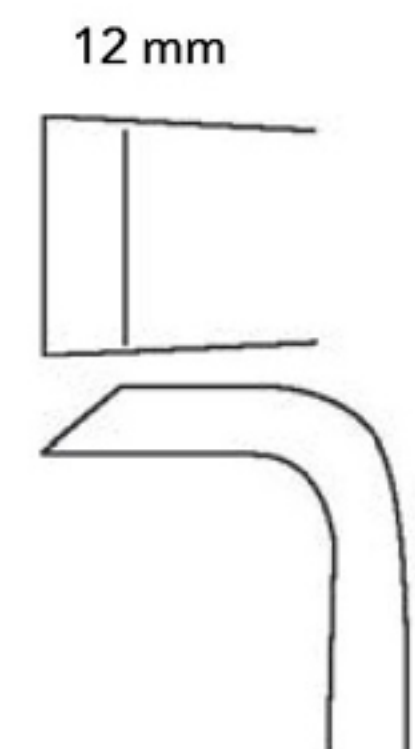

**OB400.04**  
18 cm/7"

### Periosteal Elevators



**MARTIN-HOEN**  
19 cm/6¼" 7 mm **OB400.10**  
18.5 cm/7¼" 15 mm **OB400.11**  
19 cm/7½" 20 mm **OB400.12**



**MARTIN-CUSHING**  
17.5 cm/6¾" 4 mm **OB400.20**  
17.5 cm/6¾" 6 mm **OB400.21**  
19.5 cm/7¾" 5 mm **OB400.25**  
19.5 cm/7¾" 7 mm **OB400.26**

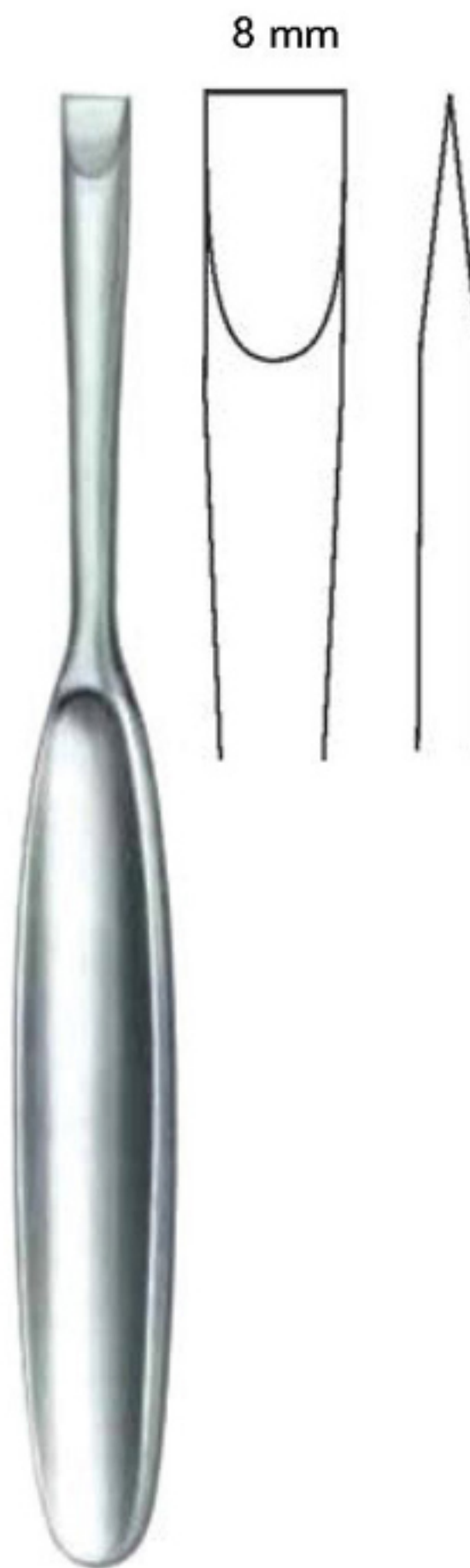

**MARTIN-CUSHING**  
**OB400.30**  
17 cm/6¾"



**LANGENBECK**  
**OB401.18**  
18 cm/7"













**LANGENBECK**  
**OB402.19**  
19 cm/7½"



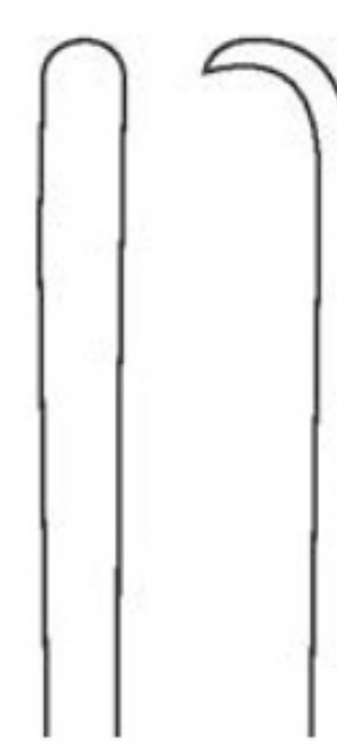
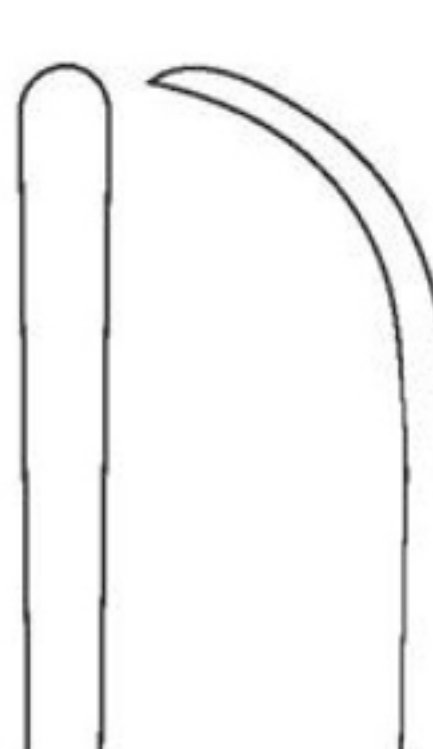
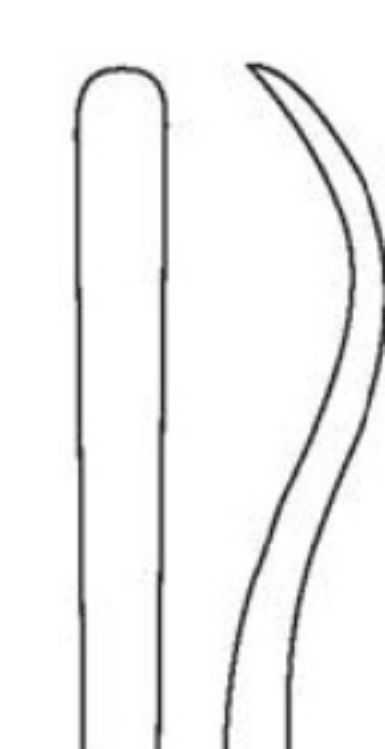

## Bone Surgery (Periosteal Elevators)

							
4.5 mm	15 mm	5 mm	8 mm	13 mm	13 mm	delicate, angled, solid	9 mm
<b>LANDOLT</b> <b>OB404.18</b> 17.5 cm/6¾"	<b>JANSEN</b> <b>OB405.17</b> 16.5 cm/6½"	<b>KOENIG</b> <b>OB406.16</b> 15.5 cm/6"	<b>TRELAT</b> <b>OB407.15</b> 15 cm/6"	<b>SCHNEIDER</b> <b>OB408.18</b> 17.5 cm/6¾"	<b>SCHNEIDER-SAUERBRUCH</b> <b>OB409.14</b> 19 cm/7½"	16 cm/6¼" 5 mm <b>OB411.05</b> 6 mm <b>OB411.06</b> 7 mm <b>OB411.07</b>	<b>COTTLE</b> <b>OB412.20</b> 19 cm/7½"
							
6 mm	18 mm	11 mm	12.5 mm	4 mm			
<b>SEWALL</b> <b>OB413.20</b> 20 cm/8"	<b>SEDILLOT</b> <b>OB414.19</b> 18.5 cm/7¼"	<b>FARABEUF-COLLIN</b> 15.5 cm/6¼" Straight <b>OB416.11</b> Curved <b>OB417.11</b>	<b>FARABEUF</b> 15.5 cm/6¼" Straight <b>OB418.15</b> Curved <b>OB419.15</b>	<b>MÜHLING</b> 17 cm/6¾"	<b>OB421.01</b>	<b>OB421.02</b>	
							
					<b>OB421.03</b>	<b>OB421.04</b>	





## Bone Surgery (Periosteal Elevators)



KEY

18 cm/7¼"	3 mm	<b>OB423.01</b>
18 cm/7¼"	6 mm	<b>OB423.02</b>
19 cm/7½"	10 mm	<b>OB423.03</b>
19 cm/7½"	13 mm	<b>OB423.04</b>
20 cm/8"	16 mm	<b>OB423.05</b>
20 cm/8"	19 mm	<b>OB423.06</b>
21 cm/8¼"	25 mm	<b>OB423.07</b>



COBB

23 cm/9"	28 cm/11"	
6 mm	<b>OB.426.06</b>	<b>OB425.06</b>
10 mm	<b>OB.426.10</b>	<b>OB425.10</b>
13 mm	<b>OB.426.13</b>	<b>OB425.13</b>
19 mm	<b>OB.426.19</b>	<b>OB425.19</b>
25 mm	<b>OB.426.25</b>	<b>OB425.25</b>



SEDILLOT  
**OB427.21**  
23 cm/9"



KAHRE-WILLIGER  
16.5 cm/6½"

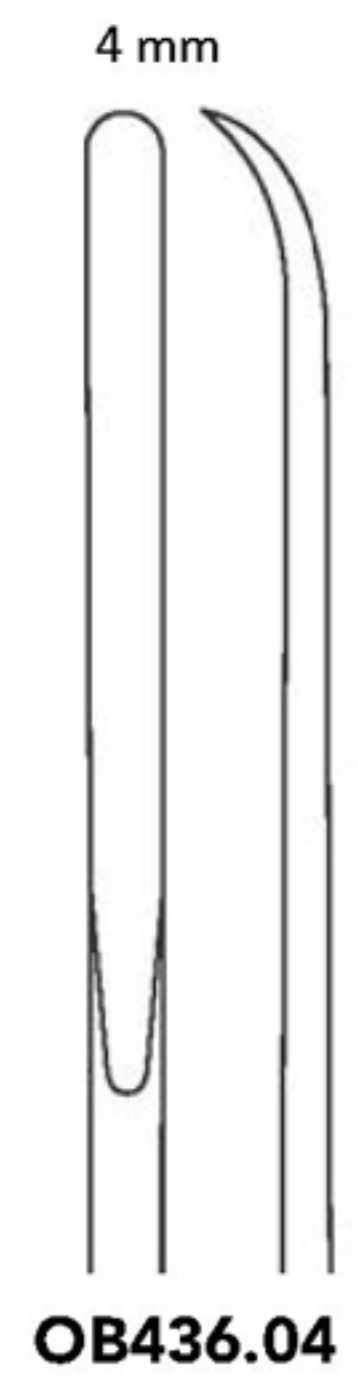

4 mm  
**OB436.04**

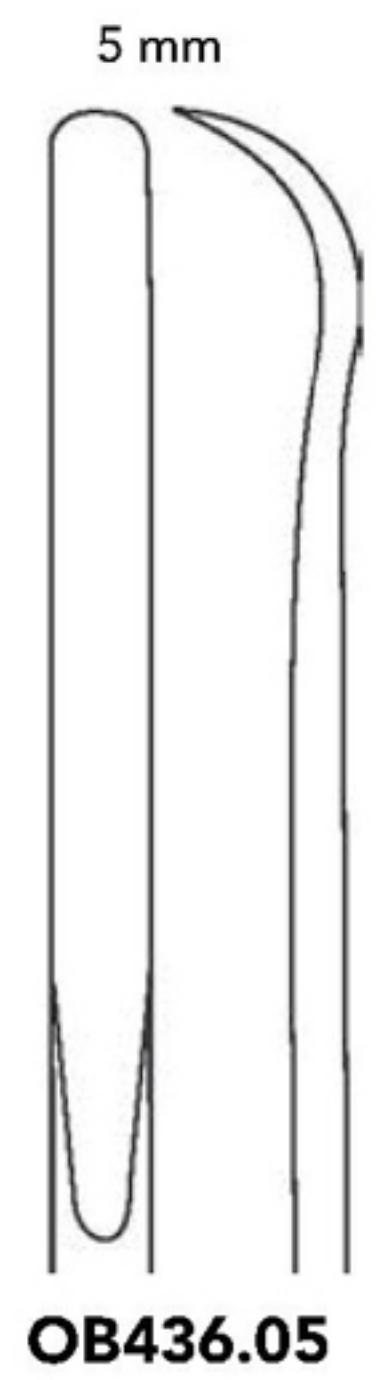

5 mm  
**OB436.05**

7 mm



WILLIGER  
**OB436.07**  
16 cm/6¼"

6 mm



WILLIGER  
**OB434.13**  
12.5 cm/5"

5 mm



WILLIGER  
**OB436.16**  
16 cm/6¼"



17 cm/7"  
3 mm **OB438.03**  
6 mm **OB438.06**



17 cm/7"  
6 mm **OB439.06**  
8 mm **OB439.08**





## Bone Surgery (Periosteal Elevators)



DOYEN

Right Curved

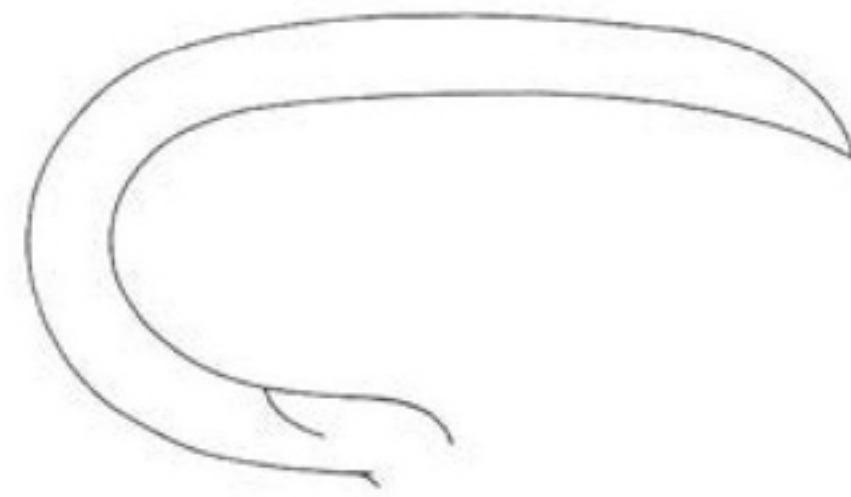

**OB441.17**  
17 cm/6¾"

Left Curved



**OB443.17**  
17 cm/6¾"

Right Curved

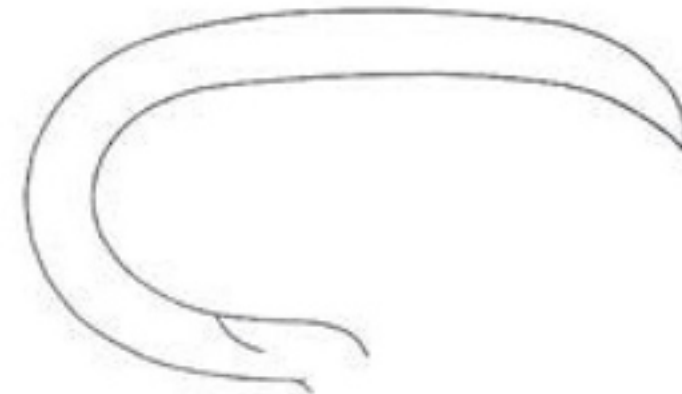

**OB445.17**  
18 cm/7"

Left Curved



**OB447.17**  
18 cm/7"



ALEXANDER  
**OB448.21**  
21 cm/8¼"



SEMB

12 mm

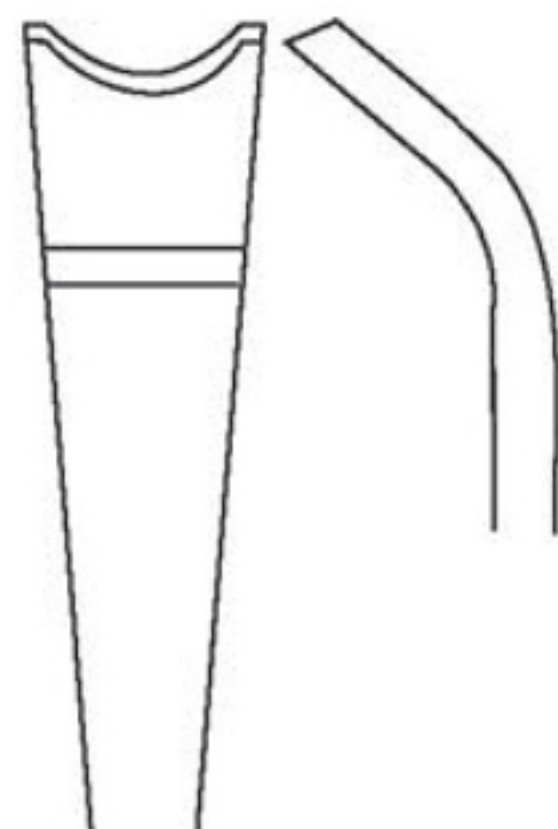

**OB450.01**  
19 cm/7½"  
Fig. 1

12 mm

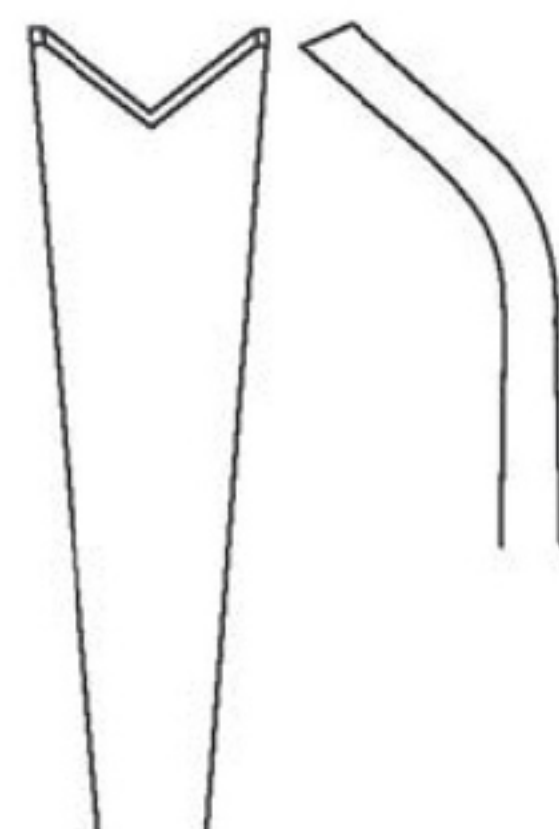

**OB450.02**  
22 cm/8¾"  
Fig. 2

13 mm

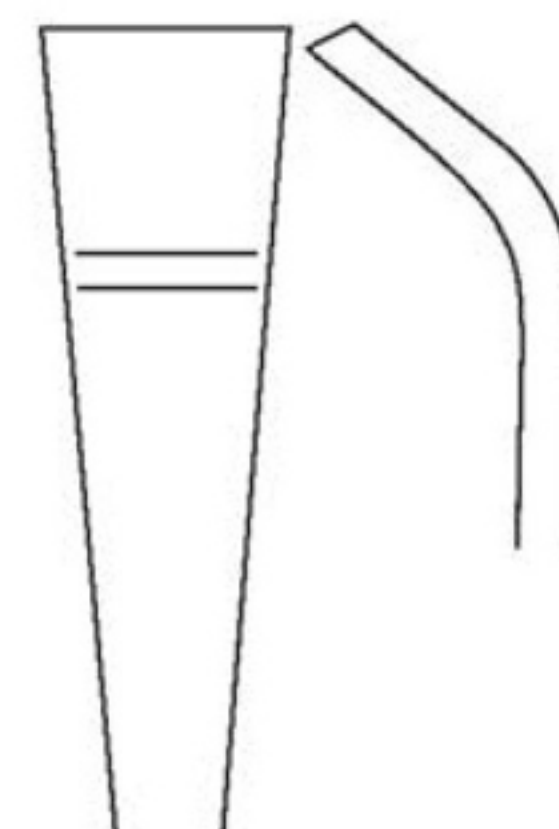

**OB450.03**  
19 cm/7½"  
Fig. 3

13 mm

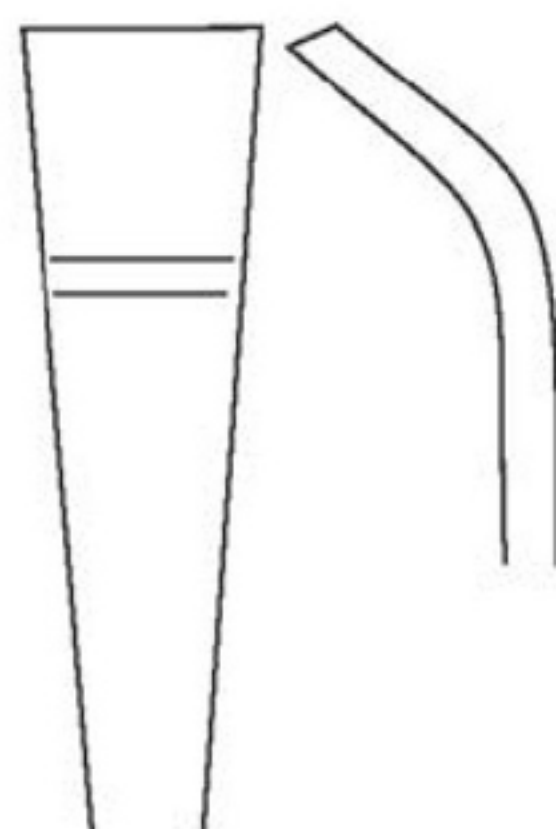

**OB450.04**  
22 cm/8¾"  
Fig. 4

15 mm



**OB450.05**  
23 cm/9"  
Fig. 5

LAMBOTTE  
21.5 cm/8½"

- 5 mm **OB461.05**
- 10 mm **OB461.10**
- 15 mm **OB461.15**
- 20 mm **OB461.20**
- 25 mm **OB461.25**







## Bone Surgery (Bone Files & Elevators)



**OB479.28**  
28 cm/11"



**OB481.24**  
25 cm/9¾"



**OB482.22**  
22 cm/8¾"



PUTTI  
**OB181.30**  
30 cm/11¾"



PUTTI  
**OB183.27**  
27 cm/10½"



ADSON  
17.5 cm/7"



**OB484.17**



**OB485.17**



**OB486.17**



**OB487.17**

downwards cutting



MILLER-COLBURN  
18 cm/7"

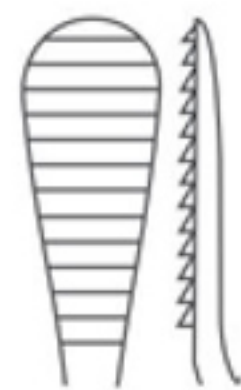

**OB490.01**  
Fig. 1

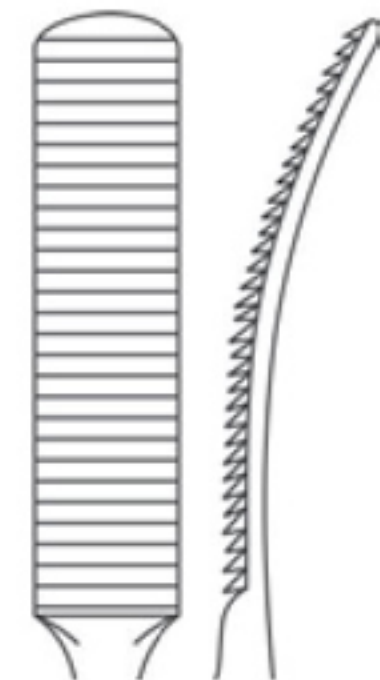

**OB490.02**  
Fig. 2

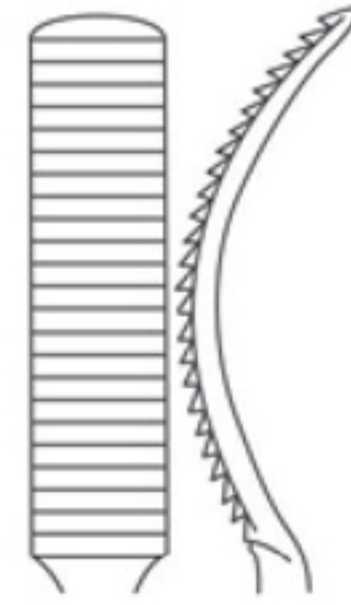

**OB490.03**  
Fig. 3

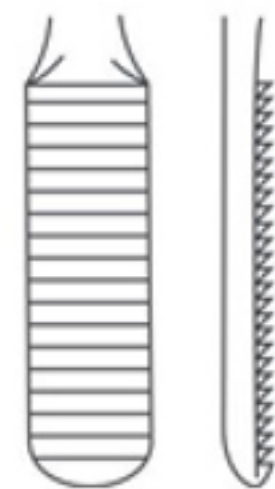

**OB490.04**  
Fig. 4

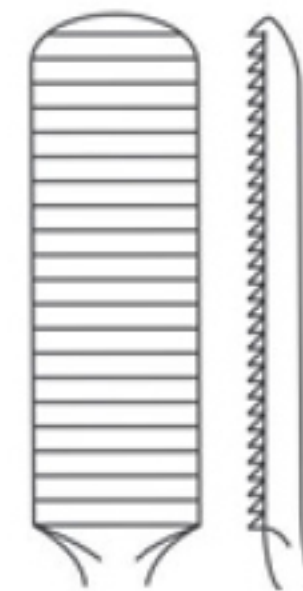

**OB490.05**  
Fig. 5

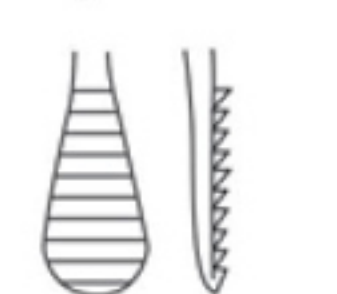
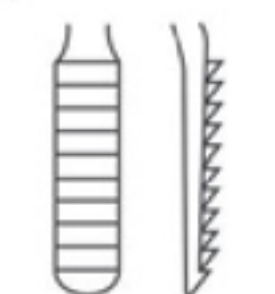

TC Jaws



MILLER  
19 cm/7½"

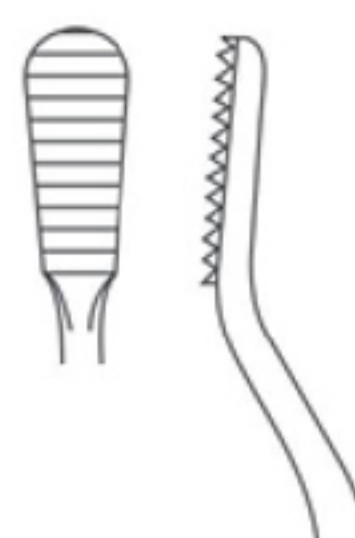

**OB492.01**

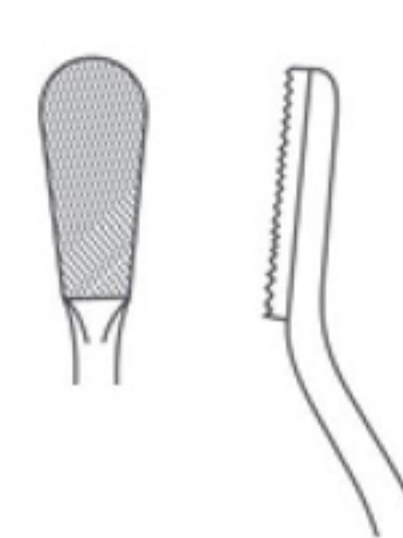

**OB493.03**

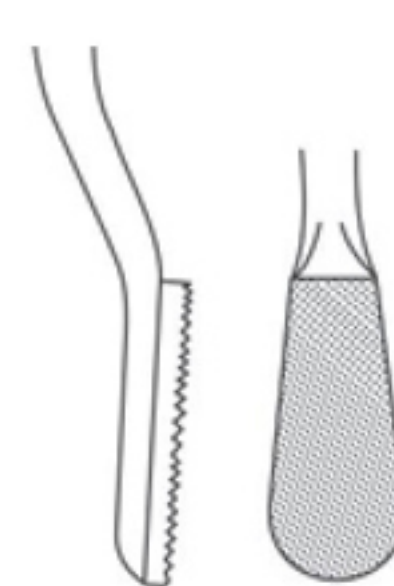
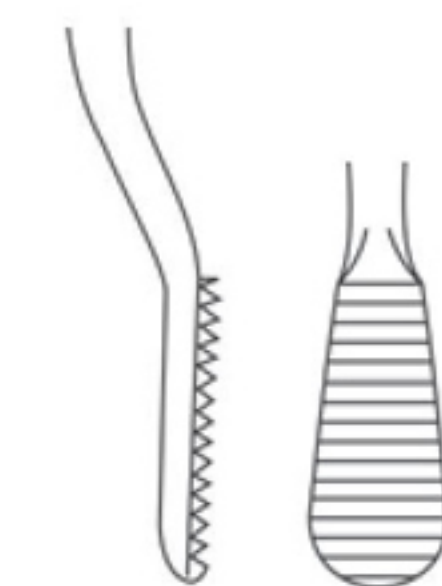

cross cutting



MILLER-COLBURN

Fig. 18 cm/7"

- 1 **OB491.01**
- 2 **OB491.02**
- 3 **OB491.03**
- 4 **OB491.04**





## Bone Surgery (Elevators & Bone Levers)



**LANGENBECK**

19.5 cm/7¾"	7 mm	<b>OB495.20</b>
19.5 cm/7¾"	10 mm	<b>OB497.20</b>
23 cm/9"	11 mm	<b>OB498.23</b>

7 mm



**WILLIGER**  
**OB510.17**  
17 cm/7"

4 mm



**WILLIGER**  
**OB513.16**  
16 cm/6¼"

5 mm



**SEBILEAU**  
**OB516.18**  
17.5 cm/7"

6 mm



**QUERVAIN**  
**OB517.20**  
19.5 cm/7¾"



**ALDERDYCE**  
**OB525.21**  
21 cm/8¼"



**MCDONALD**  
**OB527.19**  
18.5 cm/7¼"

2.8 mm

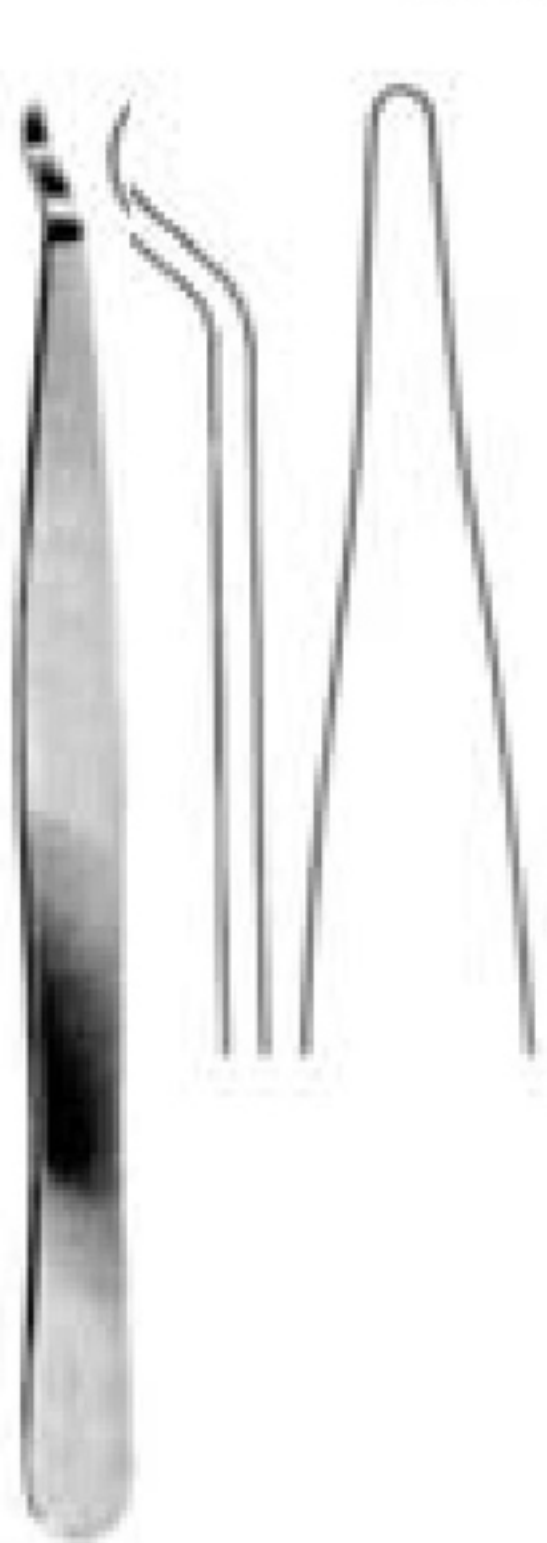

**OB960.63**  
14 cm

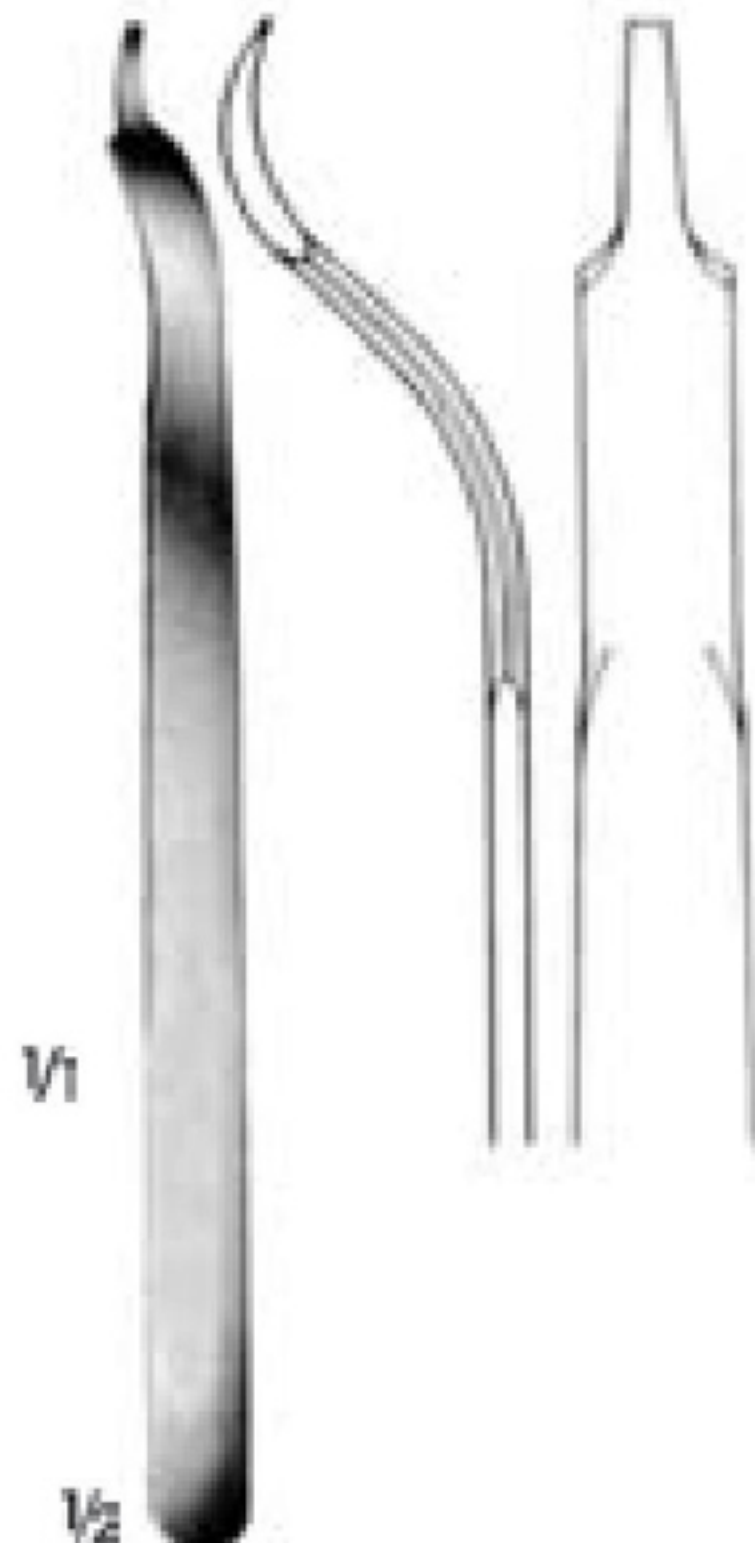

**BUCK-GRAMCKO**  
**OB960.62**  
15 cm

2 mm



**OB537.06**  
15 cm/6"



**HOHMANN, MINI**  
16 cm/6¾"  
6 mm **OB539.06**  
8 mm **OB539.08**

15 mm



**OB539.15**  
16 cm/6¾"  
**OB539.16**  
12 cm 15 mm



**BENNETT**  
24 cm/9½" 43 mm **OB559.24**  
23.5 cm/9¼" 60 mm **OB561.24**





## Bone Surgery (Bone Levers)

### Knee Retractors

39 mm



**BLOUNT  
OB563.26**  
26.5 cm/10½"

47 mm



**BLOUNT  
OB565.26**  
26.5 cm/10½"

8 mm



**HOHMANN  
OB541.08**  
21.5 cm/8¾"

18 mm



**HOHMANN  
OB541.18**  
23.5 cm/9½"

43 mm



**HOHMANN  
OB541.43**  
23.5 cm/9½"

70 mm



**HOHMANN  
OB541.70**  
25 cm/9¾"

43 mm



**HOHMANN  
OB543.43**  
23.5 cm/9½"

22 mm



**HOHMANN  
OB545.22**  
25.5 cm/10¼"

35 mm



**HOHMANN  
OB545.35**  
29 cm/11½"

24 mm



**HOHMANN  
OB547.24**  
27.5 cm/10¾"

22 mm



**LANGE-HOHMANN  
OB549.22**  
25 cm/9¾"





## Bone Surgery (Spinal Retractors, Meniscus Knives, Tendon Strippers)

	<p>C <b>OB960.32</b> Ø 2 mm</p> <p>C <b>OB960.33</b> Ø 3 mm</p> <p>C <b>OB960.34</b> Ø 4 mm</p> <p>C 1/1 <b>OB960.35</b> Ø 6 mm</p>				<p><b>BLOUNT</b> <b>OB567.17</b> 17.5 cm/6¾"</p>	
<p><b>BUNNELL</b> 13.5 cm</p>	<p><b>OB960.37</b> Ø 4 mm</p> <p><b>OB960.38</b> Ø 4.5 mm</p> <p><b>OB960.39</b> Ø 5.5 mm</p>	<p><b>TAYLOR</b> 16 cm/6¼"</p> <p>95 x 30 mm <b>OB571.16</b> 115 x 30 mm <b>OB573.16</b></p>	<p>Esnek şaft/Flexible shaft 23 cm</p>	<p><b>BLOUNT</b> <b>OB567.17</b> 17.5 cm/6¾"</p>	<p>Tendon Passer</p>	
	<p><b>OB630.17</b> Fig. 1</p>					
	<p><b>OB631.17</b> Fig. 2</p>	<p><b>NEFF</b> 22 cm/8¾"</p>	<p><b>SALENIUS</b> 21.5 cm/8½"</p>	<p><b>FISCHER</b> <b>OB660.31</b> 31 cm/12¼"</p>	<p><b>OB662.29</b> 28.5 cm/11¼"</p>	<p><b>BUNNELL</b> <b>OB664.23</b> 23 cm/9"</p>
<p>17.5 cm/7"</p>	<p>Fig. 1 Left <b>OB643.22</b> Fig. 2 Right <b>OB645.22</b></p>	<p>Fig. 1 Left <b>OB650.22</b> Fig. 2 Right <b>OB651.22</b></p>	<p><b>FISCHER</b> <b>OB660.31</b> 31 cm/12¼"</p>	<p><b>OB662.29</b> 28.5 cm/11¼"</p>	<p><b>BUNNELL</b> <b>OB664.23</b> 23 cm/9"</p>	





## Bone Surgery (Tendon Holding Forceps, Tendon Tunnelling Forceps)



**STEINMANN**  
**OB674.16**  
16 cm/6½"



**BRAND**  
15.0 cm/6" **OB676.15**  
19.0 cm/7½" **OB676.19**  
24.5 cm/9¾" **OB676.24**

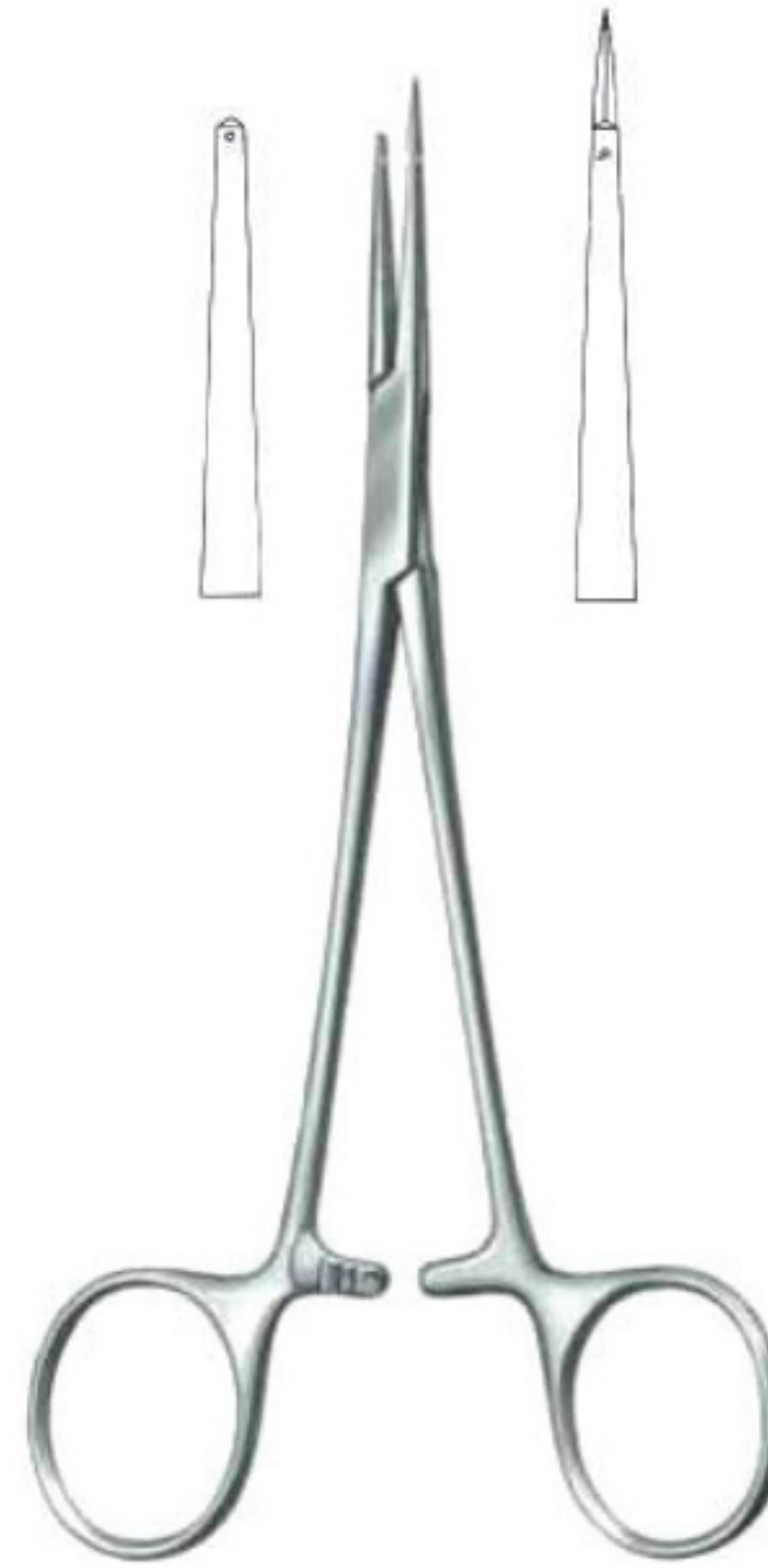

**OB682.16**  
15 cm/6"



**OB683.16**  
15 cm/6"



**OB717.12**  
13.5 cm/5¼"

### Bone holding forceps



**OB704.14**  
14.5 cm/5¾"



**OB680.13**  
11.5 cm/4½"



**BIRCHER-GANSKE**  
21.0 cm/8¼" Straight **OB710.20**  
20.5 cm/8" Curved up **OB611.20**



**BIRCHER-GANSKE**  
**OB713.20**  
20 cm/8"





## Bone Surgery (Tendon Holding Forceps, Tendon Tunnelling Forceps)



2:3  
21.0 cm/8¼"  
Straight      Curved  
**OB678.00**   **OB678.01**



**LEWIN**  
**OB718.17**  
18 cm/7"



**MARTIN**  
**OB716.19**  
18.5 cm/7¼"

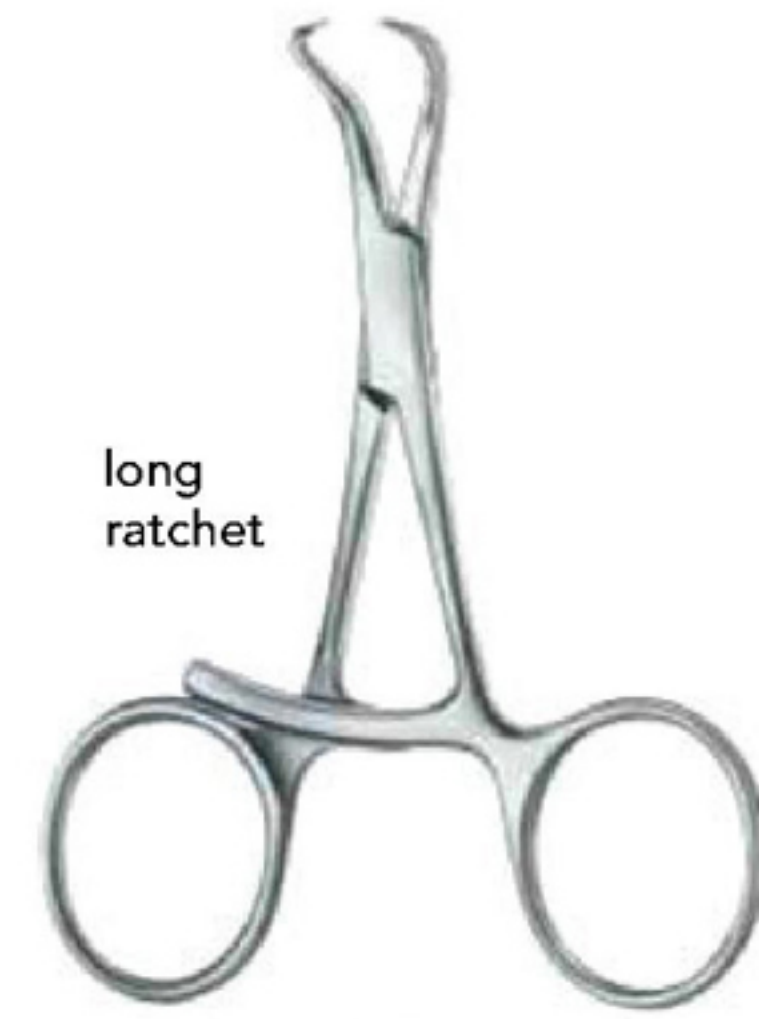

long ratchet

**OB721.09**  
14 cm/5½"

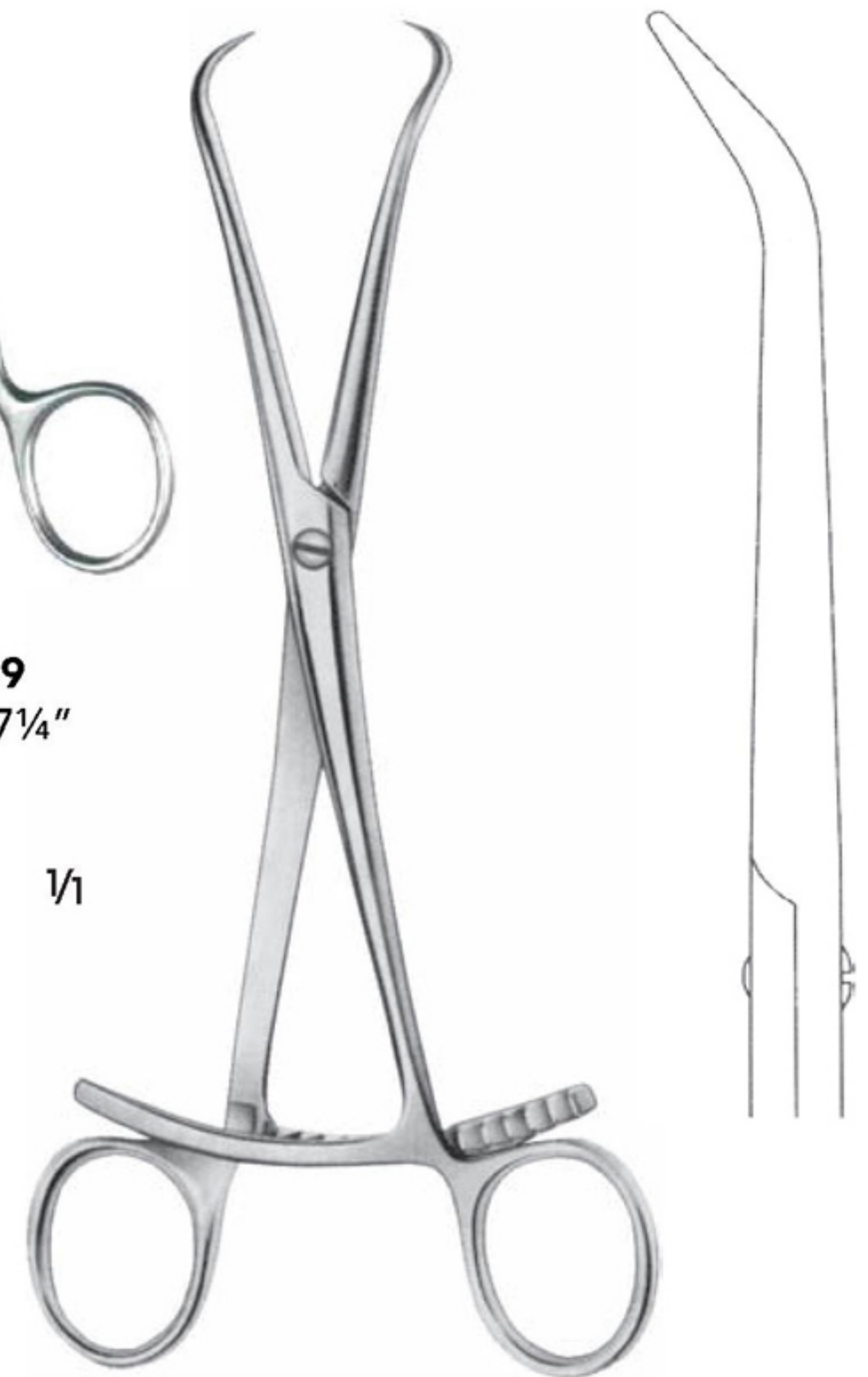

1/1

**OB960.28**  
Pozisyon pensi  
Reposition forceps  
20.5 cm



**DINGMANN**  
**OB715.19**  
18.5 cm/7¼"

Bone holding forceps



long ratchet

**OB721.14**  
14 cm/5½"



delicate

**OB716.14**  
14 cm/5½"



**CARROLL**  
**OB679.11**  
11.5 cm/4½"





## Bone Surgery (Bone Holding Forceps)



**LANGENBECK**  
**OB722.21**  
21 cm/8¼"



**FERGUSSON**  
**OB724.21**  
21 cm/8¼"



**FROSCH**  
**OB726.18**  
18 cm/7"



**OB727.20**  
20 cm/8"



**OB729.16**  
17.5 cm/7"



**OB729.24**  
17.5 cm/7"

with thread fixation



**KERN**  
17.0 cm/6¾" **OB730.17**  
24.5 cm/9¾" **OB730.21**



**SEMB**  
**OB731.19**  
19.5 cm/7¾"



**OB732.23**  
23 cm  
**OB734.26**  
26 cm/10¼"





## Bone Surgery (Bone Holding Forceps)



with thread fixation

ULRICH

	Straight	Angled
23 cm/9"	<b>OB746.23</b>	<b>OB747.23</b>
25 cm/10"	<b>OB746.25</b>	<b>OB747.25</b>
28 cm/11"	<b>OB746.28</b>	<b>OB747.28</b>



1/2

5 mm

VERBRUGGE  
**OB960.61**  
17.5 cm



VERBRUGGE

25 cm/10"	<b>OB755.01</b>
26 cm/10 1/4"	<b>OB755.02</b>
27.5 cm/10 3/4"	<b>OB755.03</b>



LANE  
33 cm/13"

With Ratchet	Without Ratchet
<b>OB750.33</b>	<b>OB752.33</b>

detachable, Amputation Retractor

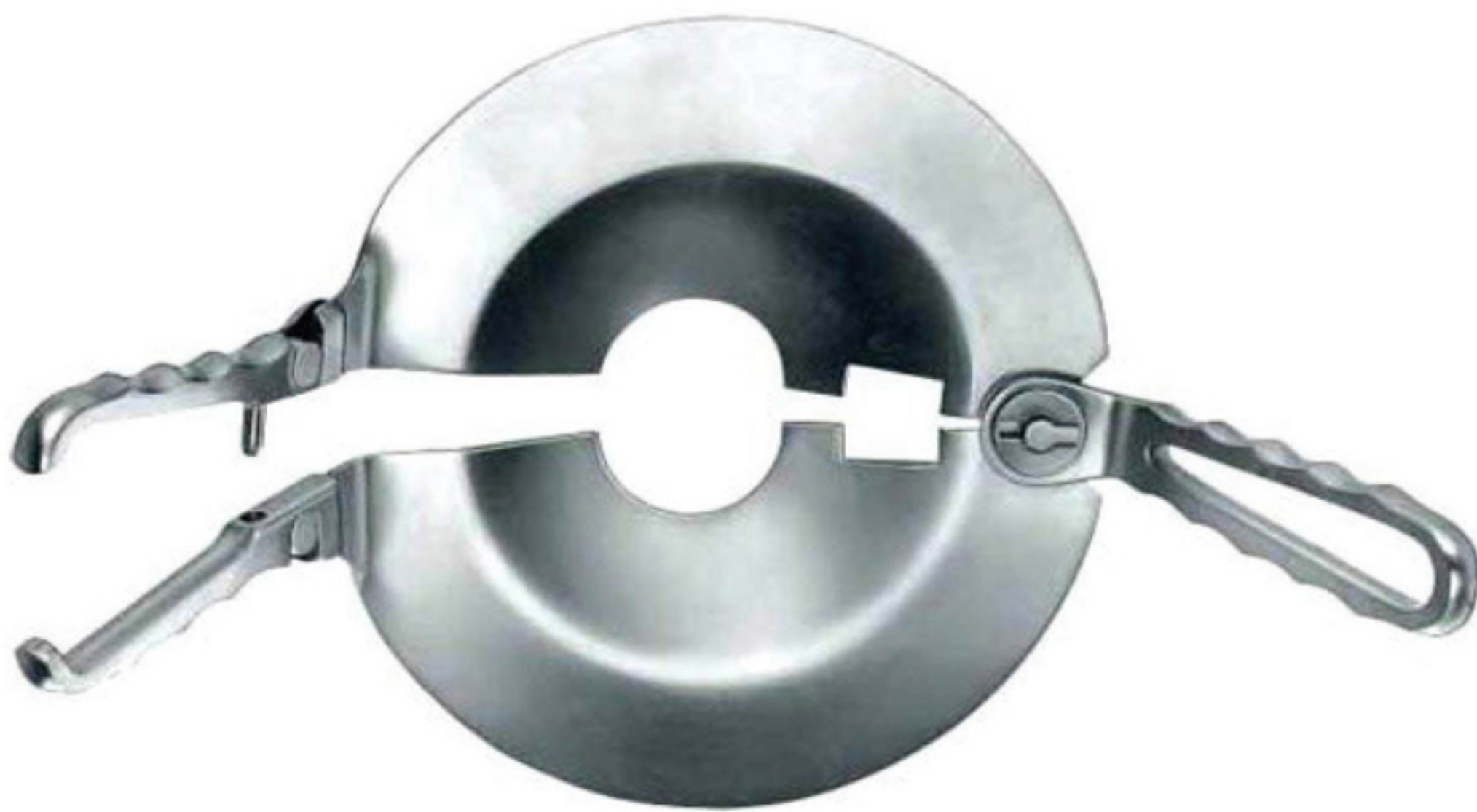

PERCEY  
**OB762.30**



LOWMAN

16 cm	<b>OB960.29</b>
18 cm	<b>OB960.30</b>
20 cm	<b>OB960.31</b>





## Bone Surgery (Bone Rongeurs)



STELLBRINK

**OB777.01**  
17.0 cm/7"



**OB777.02**  
16.5 cm/6½"



FRIEDMANN  
**OB799.12**  
12.5 cm/4¾"



FRIEDMANN  
**OB801.14**  
13.5 cm/5¼"



delicate long tip

FRIEDMANN  
**OB803.14**  
13.5 cm/5¼"



CLEVELAND  
**OB805.14**  
13.5 cm/5¼"



CLEVELAND  
**OB807.17**  
16.5 cm/6½"



MEAD  
**OB815.16**  
16.5 cm/6½"



MEAD  
**OB816.16**  
16.5 cm/6½"



HARTMANN  
**OB819.18**  
17.5 cm/7"



LUER  
18.0 cm/7"  
Straight **OB846.17**  
Curved **OB847.17**





## Bone Surgery (Bone Rongeurs)



JANSEN



**OB826.18**  
18 cm/7"



**OB829.18**  
18.0 cm/7"



BLUMENTHAL  
16.0 cm/7"

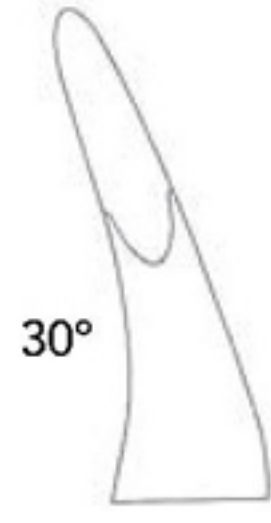

**OB835.15**

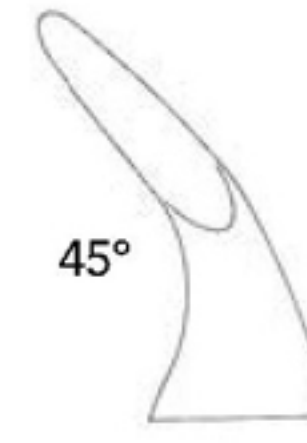

**OB837.15**

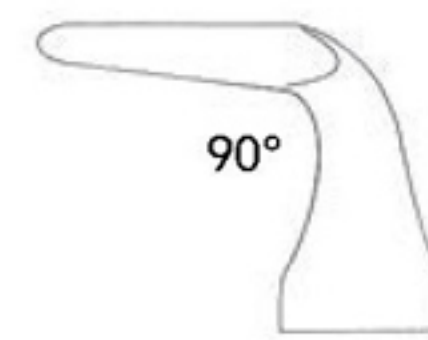

**OB839.15**

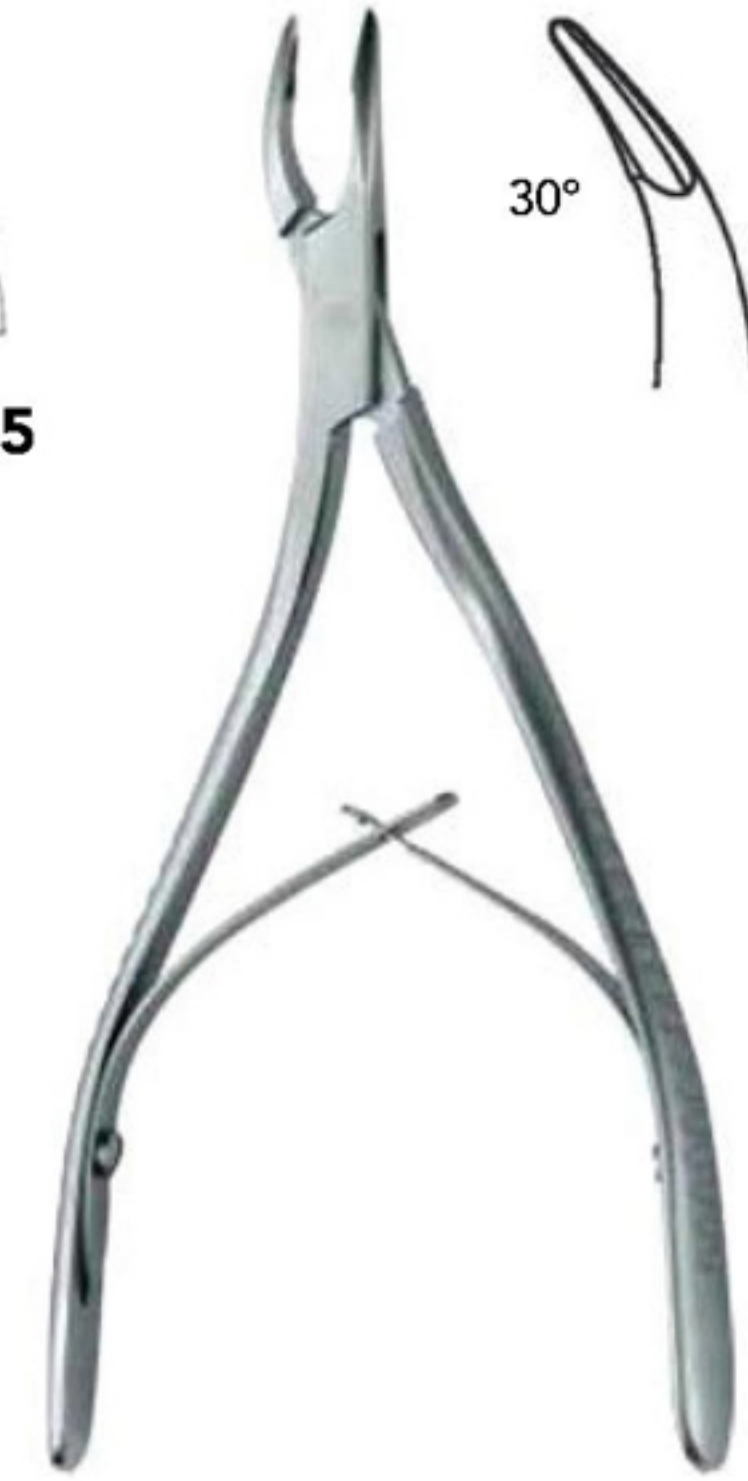

**OB835.30**  
15.5 cm/6"



**OB836.00**  
15.5 cm/6"



**OB836.30**  
15.5 cm/6"



**OB836.90**  
14.5 cm/5¾"



ZAUFAL-JANSEN  
**OB881.30**  
18 cm/7"





## Bone Surgery (Bone Rongeurs)



**BEYER**  
**OB879.18**  
18 cm/7"



**MAYFIELD**  
**OB883.17**  
18 cm/7"



**MARQUARD**  
**OB885.20**  
20.5 cm/8"



**RUSKIN**  
**OB887.18**  
19 cm/7½"



**LEMPERT**  
19 cm/7½"

Straight **OB832.19**    Curved **OB833.19**



**LUER**  
14.5 cm/5¾"

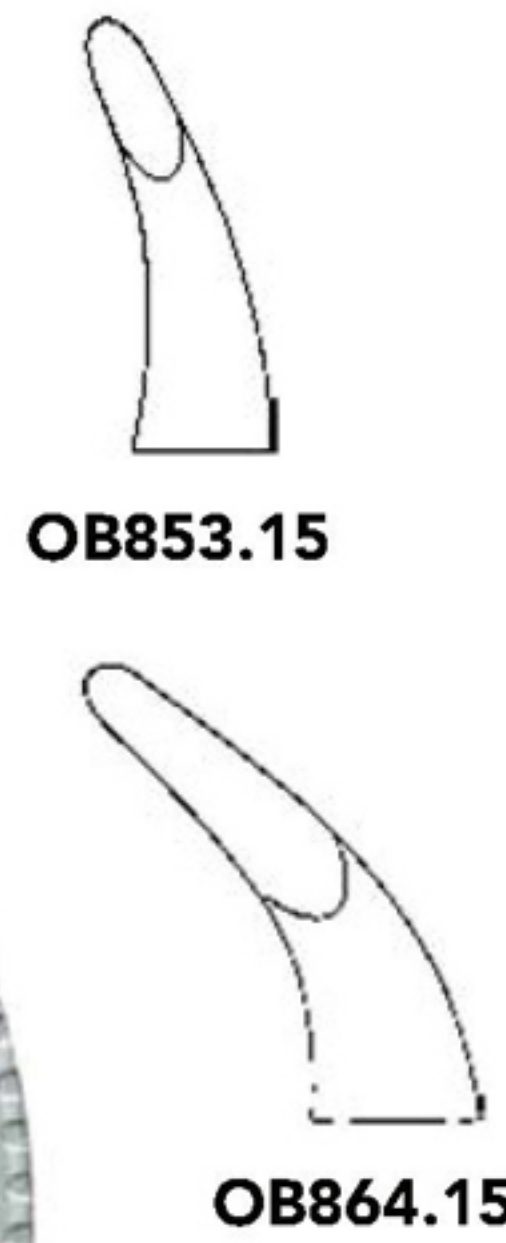

**BOEHLER** ½  
15 cm/6"

Straight **OB876.15**    Curved **OB877.15**

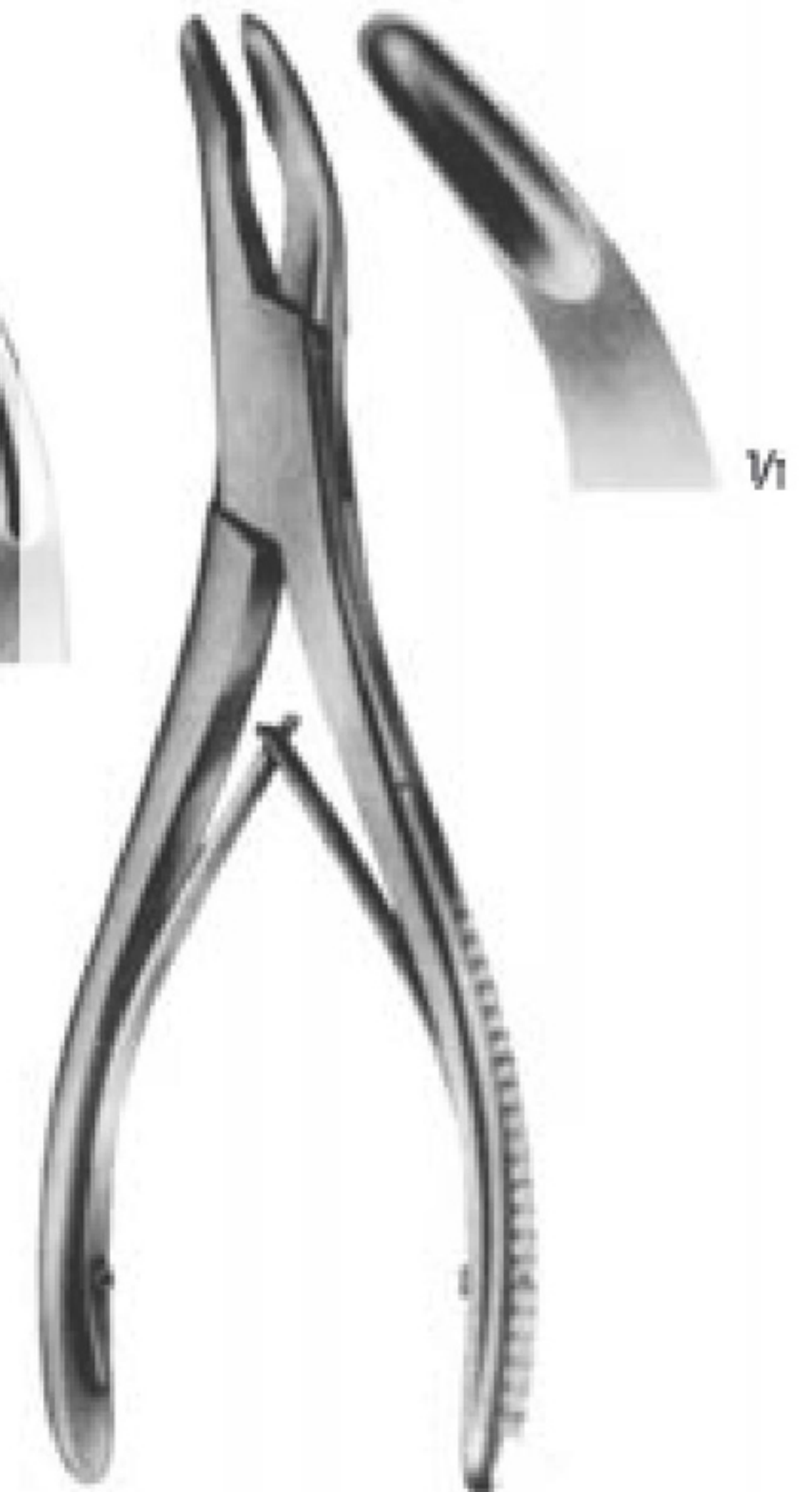

**OLIVECRONA**  
**OB960.54**  
20.5 cm





## Bone Surgery (Bone Rongeurs)



SEMB  
**OB895.22**  
23.5 cm/9¼"



FRYKHOLM  
**OB909.24**  
24.5 cm/9½"



LEKSELL-STILLE  
24.5 cm/9½"



4 mm  
**OB811.22**



8 mm  
**OB810.22**



ECHLIN  
23 cm/9"



2 mm  
**OB899.02**



3 mm  
**OB899.03**



4 mm  
**OB899.04**



STILLE-RUSKIN  
**OB901.23**  
23.5 cm/9¼"



RUSKIN  
**OB893.23**  
24 cm/9½"





## Bone Surgery (Bone Rongeurs)



STILLE  
OB897.23  
22.5 cm/8¾"



SAUERBRUCH  
31 cm/12¼"

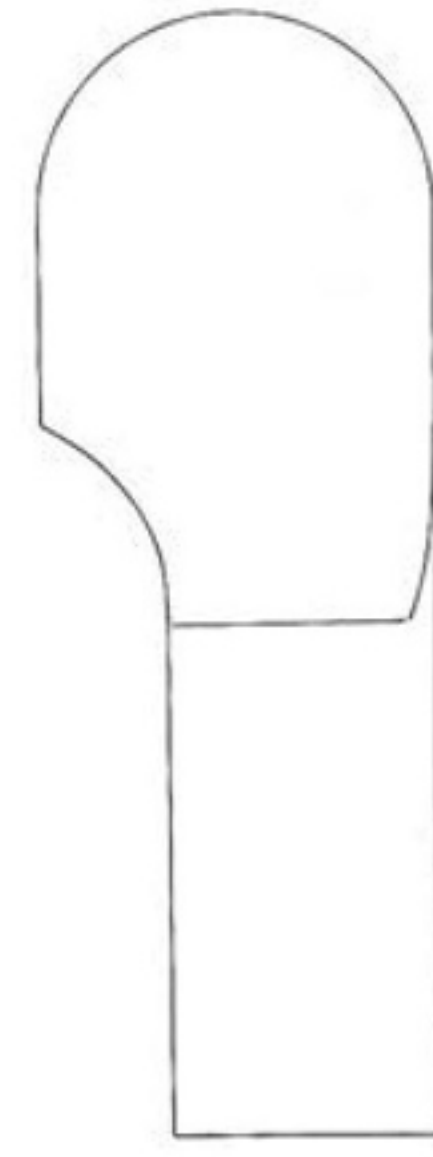

OB918.30

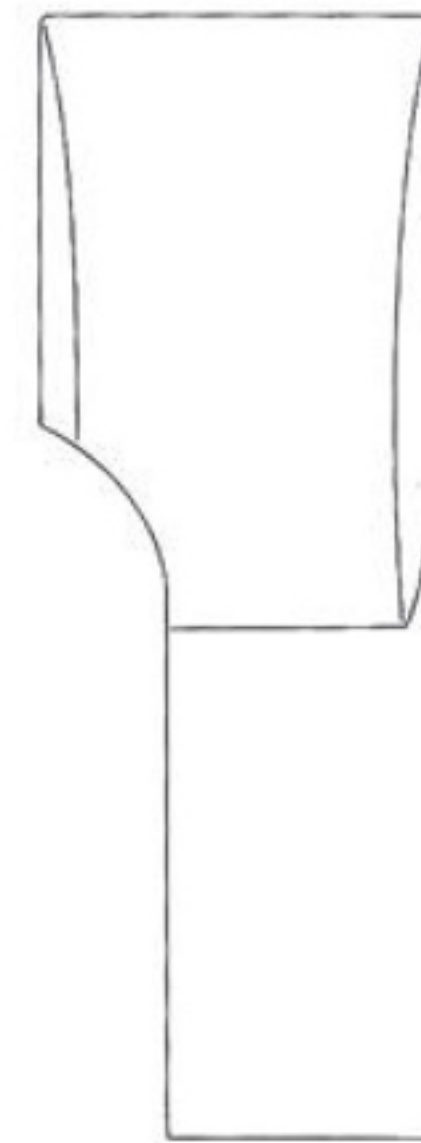

OB916.30



LEKSELL-STILLE  
OB1000.01  
24 cm



	STILLE-LUER	
	Straight	Curved
23 cm/9"	OB912.23	OB913.23
27 cm/10¾"	OB912.27	OB913.27





## Bone Surgery (Bone Cutting Forceps)



**COTTLE-KAZANJIAN**  
**OB930.19**  
19 cm/7½"

Straight



**LISTON**  
14 cm/5½" **OB934.14**  
17 cm/6¾" **OB934.17**  
20 cm/8" **OB934.19**  
22 cm/8¾" **OB934.22**

Curved



**LISTON**  
14 cm/5½" **OB935.14**  
17 cm/6¾" **OB935.17**  
20 cm/8" **OB935.19**  
22 cm/8¾" **OB935.22**



**CLEVELAND**  
**OB939.17**  
17 cm/7"



**CLEVELAND**  
**OB941.15**  
14.5 cm/5¾"

Straight



**BOEHLER**  
**OB944.15**  
14.5 cm/5¾"

Curved



**BOEHLER**  
**OB946.15**  
14.5 cm/5¾"



**CLEVELAND**  
**OB947.16**  
17 cm/7"



**OB950.18**



**OB951.18**



**RUSKIN-LISTON**  
17 cm/7"





## Bone Surgery (Bone Cutting Forceps)



SEMB  
OB959.24  
24.5 cm/19<sup>3</sup>/<sub>4</sub>"



STILLE-LISTON  
OB952.27  
17 cm/7"



STILLE-LISTON  
23.5 cm/10<sup>3</sup>/<sub>4</sub>" OB955.23  
28 cm/11" OB955.27



STILLE-LISTON  
OB954.27  
28 cm/11"



LISTON-KEY  
OB957.27  
26 cm/10<sup>1</sup>/<sub>4</sub>"





## Bone Surgery (HAND SAWS)

BIER  
**OB960.23** Komple/Complete  
 42 cm  
 Length blade  
 Bleyd uzunluđu  
 27 cm

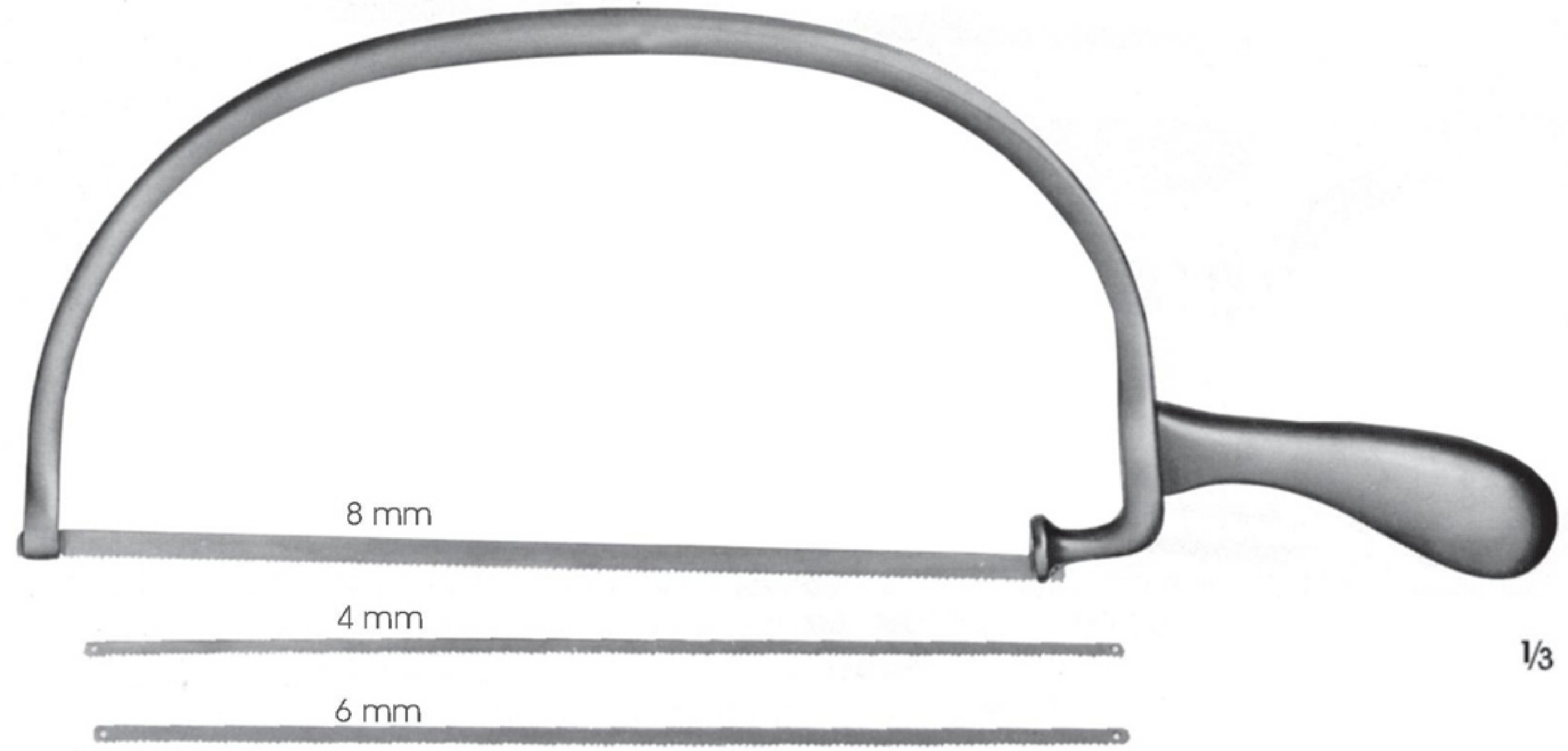

CHARRIERE  
**OB960.24** Komple/Complete  
 35 cm

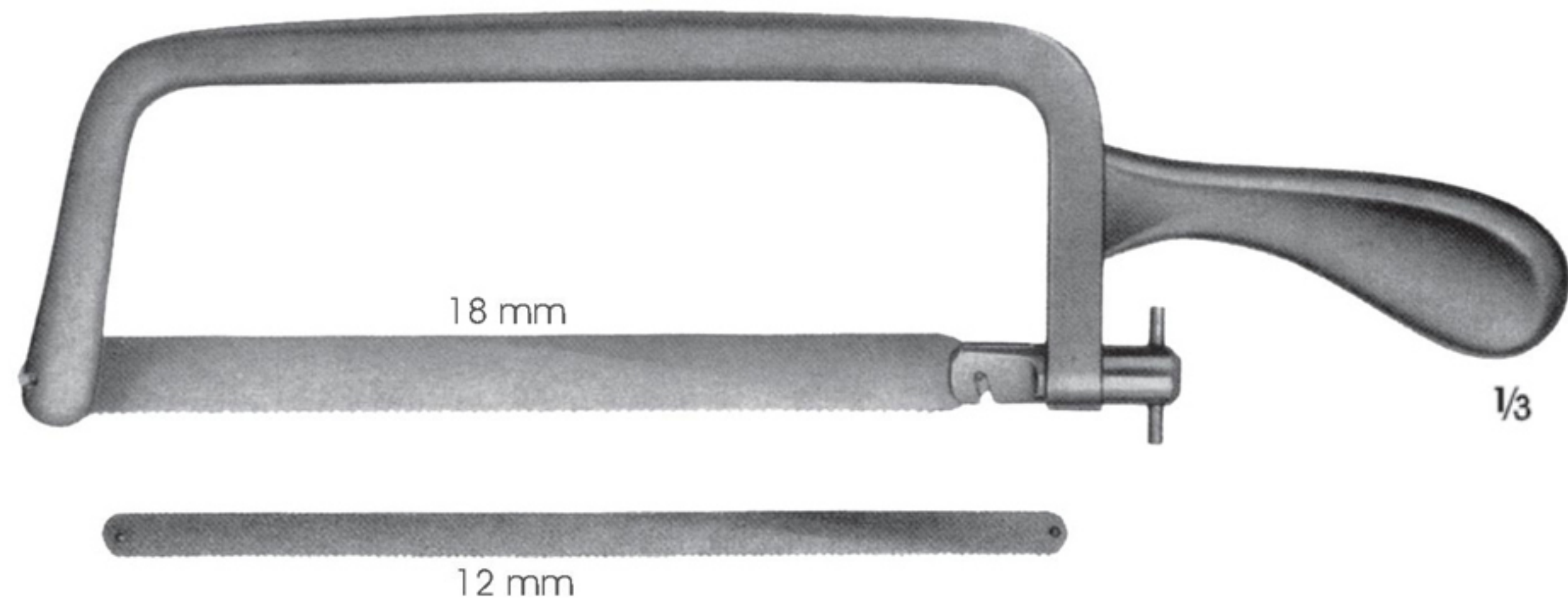

CHARRIERE  
**OB960.25** 27 cm  
**OB960.26** 34 cm

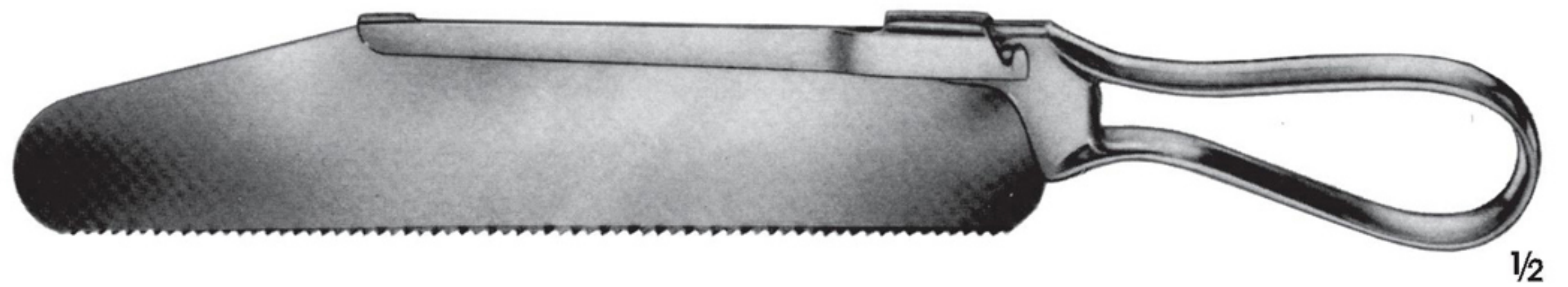

SATTERLEE  
**OB960.27**  
 29 cm

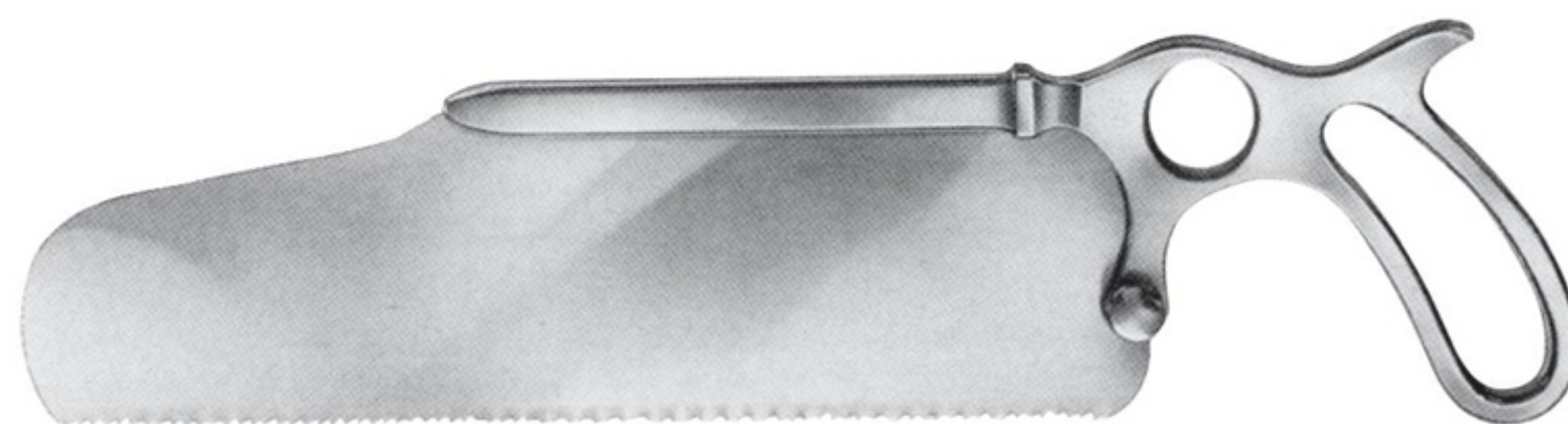





## Bone Surgery (Wire Bender Pliers & Extractors)



**OB960.57**  
Tırtıllı ağız  
With serrated jaws

Tel bükücü, düz burunlu  
wire twister, flat nosed  
17 cm

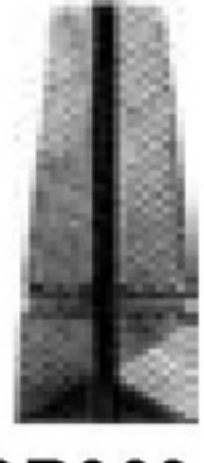

**OB960.41**  
Boylamasına ve  
çapraz kanallı  
With longitudinal  
and transversal  
grooves



**OB960.42**  
Tel tutma pensi, düz burunlu  
Wire holding forceps, flat nosed  
19 cm



MARBURG MODELL  
**OB960.64**  
Tel tutma pensi,  
Düz burunlu, tırtıllı ağız  
Wire holding forceps,  
Flat nosed, with serrated jaws  
14 cm

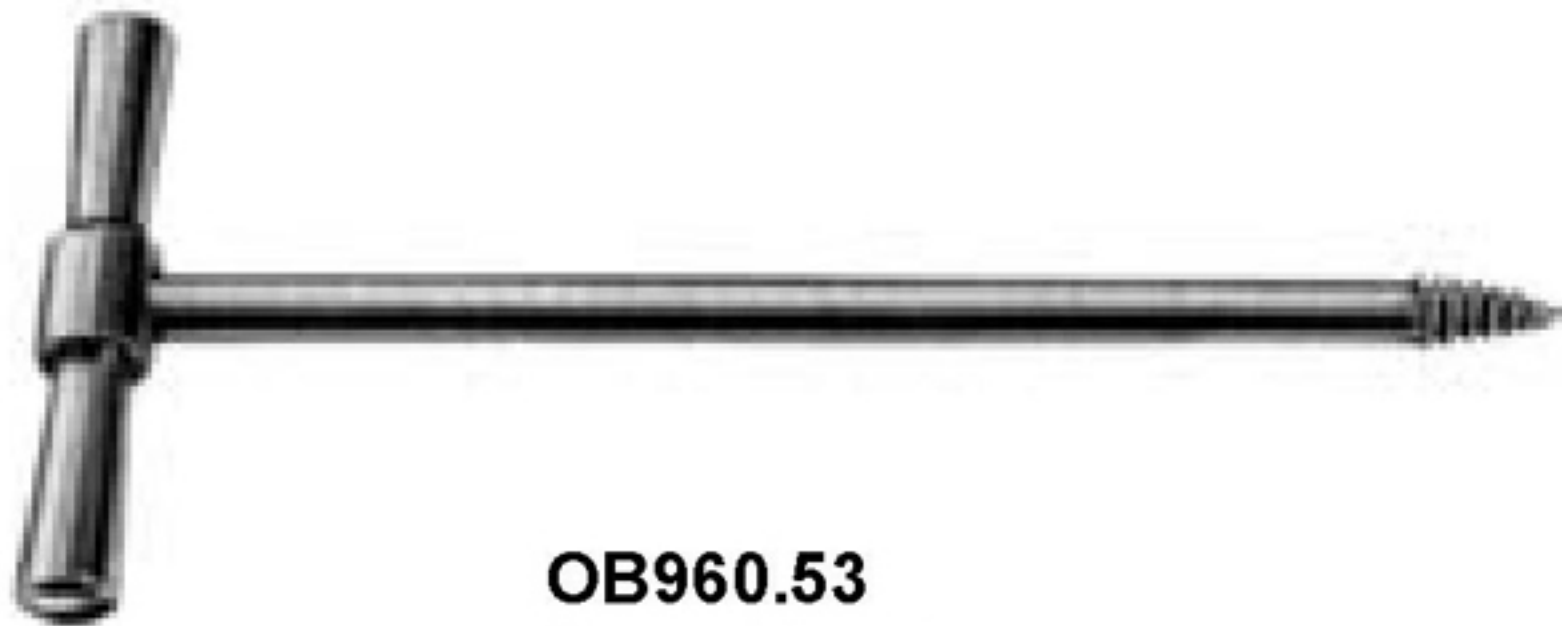
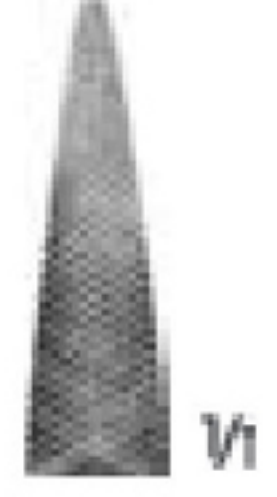

**OB960.53**  
Çıkartıcı/Extractor  
25 cm



**OB961.53**  
Çıkartıcı/Extractor  
27 cm



**OB960.56A**  
Parmak yüzük testere  
Finger ring saw  
15 cm

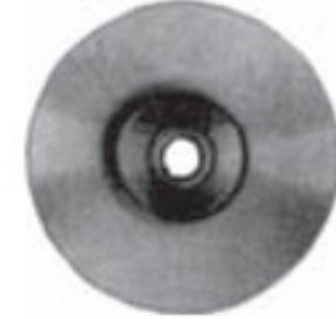

**OB960.56B**  
Yedek bıyık  
Spare blade

**OB960.55**  
STAPLER SÖKÜCÜ  
STAPLER REMOVER  
9 cm







## Bone Surgery (Wire Cutting Pliers & Nippers)



Flat nose pliers

**OC505.17**  
17 cm/6¾"



**OC507.18**  
18 cm/7"



Flat nose plier



Hackstock  
**OC518.16**  
16 cm/6¼"



Wire nipper

MARTIN-Diamant  
**OC522.16**  
16 cm/6¼"

Side-cutting plier

Extracting forceps



**OC511.01**  
18 cm/7"



TC Jaws



**OC523.22**  
22 cm/8¾"

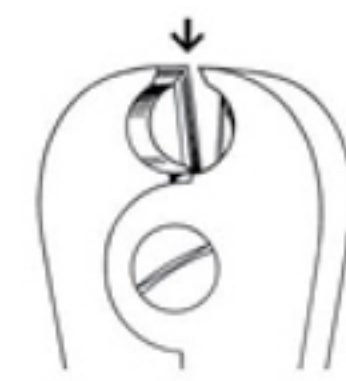

TC Jaws

Combination cutting plier



**OC526.18**  
22 cm/8¾"



TC Jaws

Wire twisting forceps



**OC500.20**  
20 cm/8"





## Bone Surgery (Wire Cutting Pliers & Nippers)

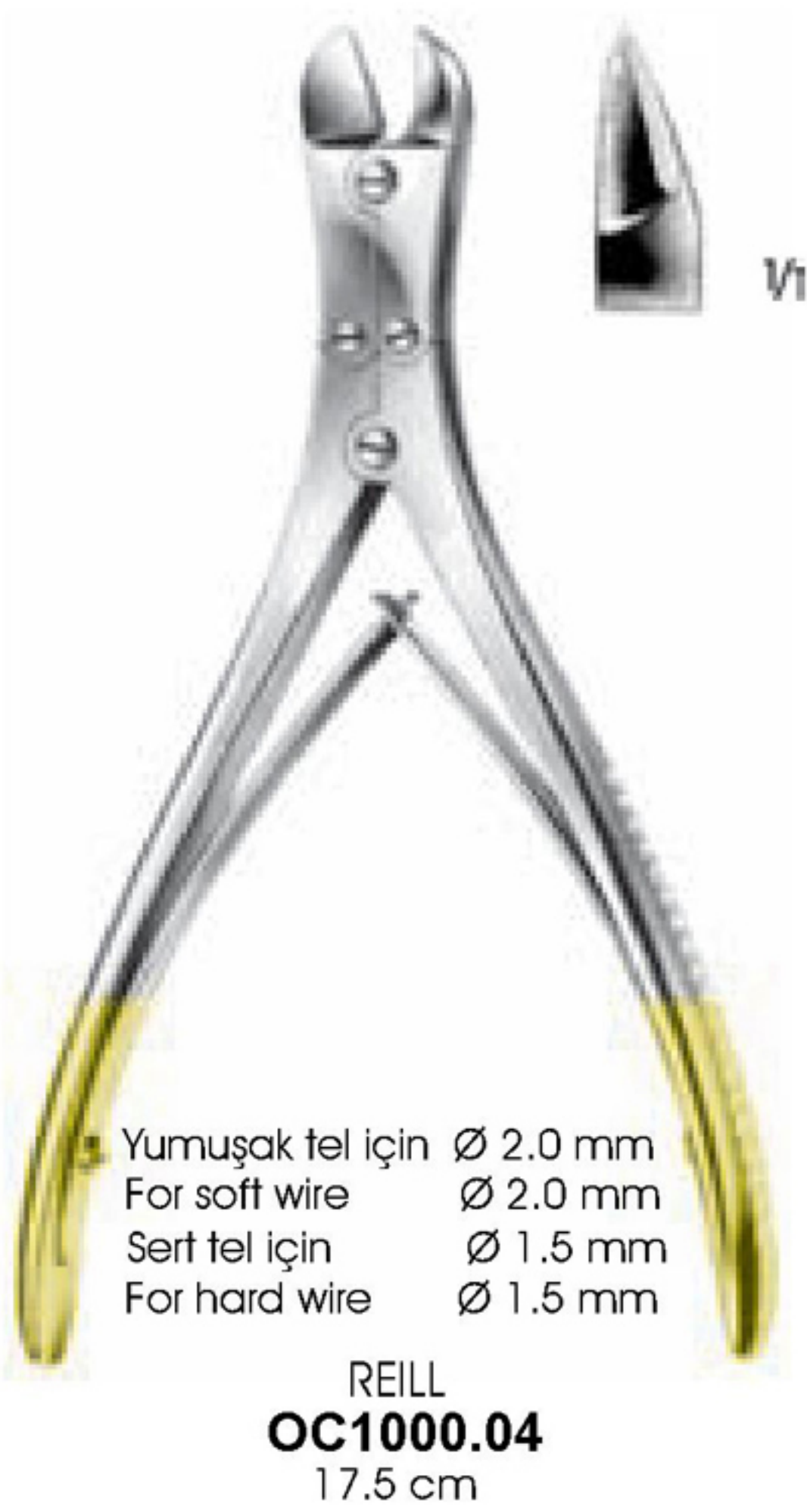





## Bone Surgery (Bending Pliers, Plate Cutter)



Bending press

**OC229.30**

Plate cutter



**OC528.55**  
55 cm/22"

Plate bending plier



**OC229.20**

Bending pliers for small plates



**OC229.22**  
22 cm/8¾"

Plate bending plier



**OI124.16**  
16 cm/6¼"





## Bone Surgery (Gauges, Measuring Sleeves, Drill Bit Guides)

Bending iron for small plates



**OC229.04**  
14.5 cm/5¾"

**OC229.05**  
14.5 cm/5¾"

Depth gauge, small



**OC219.04**  
16 cm/6¼"

Depth gauge, large



**OC219.05**  
22 cm/8¾"

measuring sleeve



**OC228.05**  
15.5 cm/6"

measuring sleeve



**OC238.05**  
20.5 cm/8"

Sharp hook



**OC219.39**  
15.5 cm/6"

Drill bit guides

sleeve & drill bit guide



**OC212.27**  
10.5 cm/4"



**OC222.21**  
12 cm/4¾"



**OC222.32**  
14 cm/5½"

for compression hole



**OC222.43**  
18 cm/7"



**OC222.44**  
16.5 cm/6½"





## Bone Surgery (Wire Traction Bows)

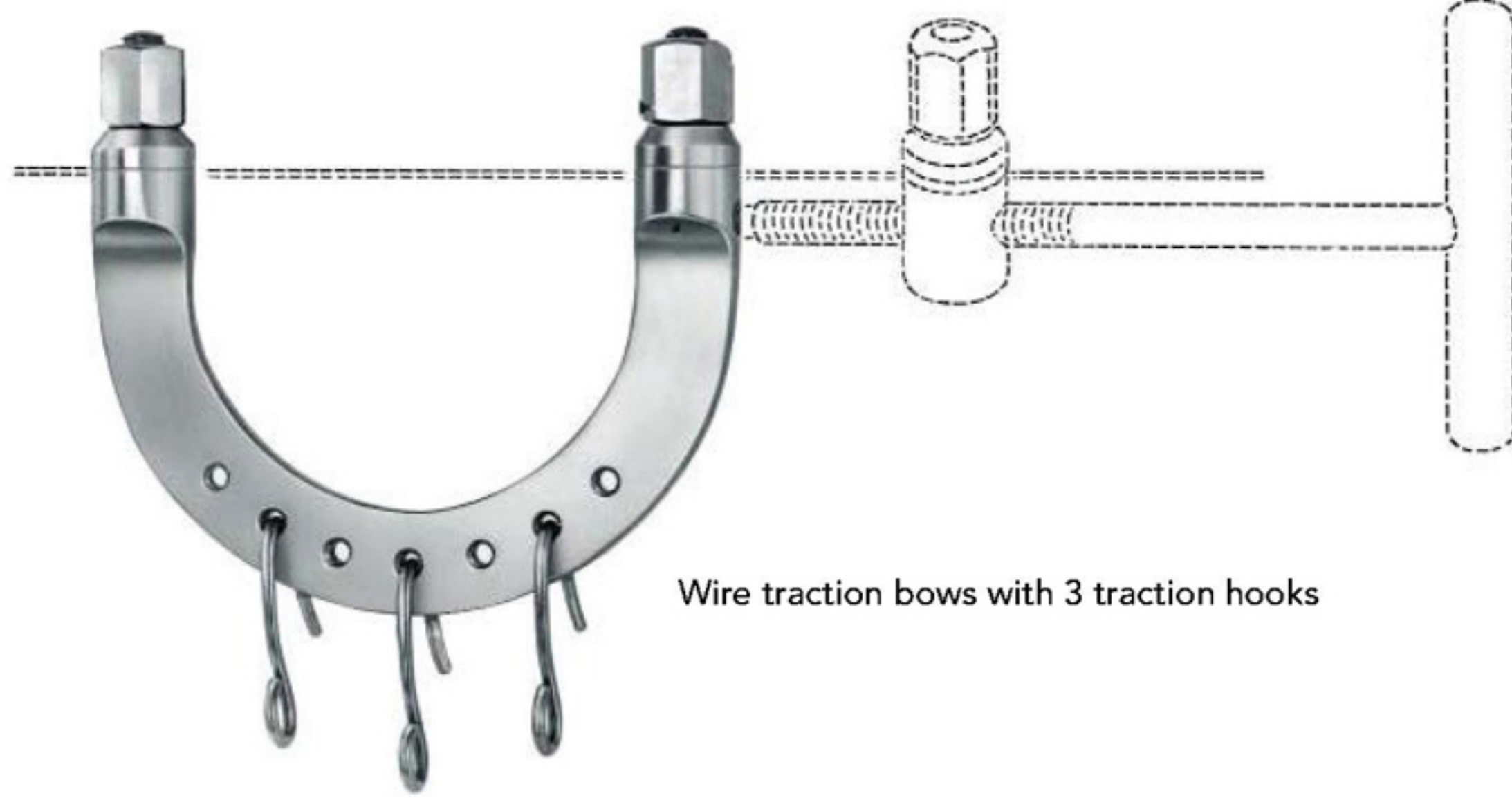

Wire traction bows with 3 traction hooks

### KIRSCHNER

95 x 70 mm	<b>OC581.01</b>
105 x 105 mm	<b>OC581.02</b>
120 x 120 mm	<b>OC581.03</b>
155 x 155 mm	<b>OC581.04</b>

Wire strainer



**OC586.18**  
18.5 cm/7¼"

Traction hook for extension bows



**OC603.06**  
18.5 cm/7¼"



with 3 traction hooks

### KIRSCHNER

18.5 cm/7¼"	<b>OC585.01</b>
26.5 cm/10¼"	<b>OC585.02</b>

Wrench



**OC587.20**  
20 cm/8"



180 x 100 mm	<b>OC589.18</b>
270 x 160 mm	<b>OC589.27</b>





## Bone Surgery (Hand Drills, Wire Traction Bows)

Ø 4 mm



Steinmann Pins, with trocar tip

- 14 cm/5½" **OC562.14**
- 16 cm/6¼" **OC562.16**
- 18 cm/7" **OC562.18**
- 20 cm/8" **OC562.20**



Wire traction bows

**BOEHLER**

- 210 x 150 mm **OC565.15**
- 160 x 90 mm **OC565.16**
- 210 x 110 mm **OC565.21**

with three jaw chuck, longitudinal bore



**BUNNEL**  
**OC606.00**

with three jaw chuck and pin key

Wrench



**OC620.99**

with three jaw chuck



**RALK**  
**OC611.01**



**OC.620.05**

Handle with three jaw chuck, with key

Ayarlı sap  
Adjustable handle



**OC1000.03**  
El matkabi/Hand drill only  
28 cm

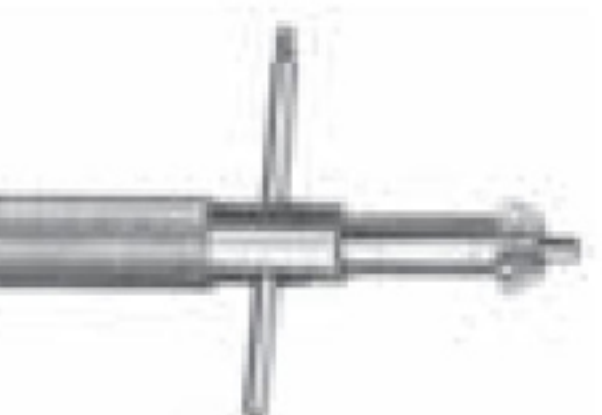

Anahtar/Key





## Bone Surgery (Screw Drivers)

2.5 mm  
**OC368.21**  
 21 cm/8¼"

3.5 mm  
**OC369.21**  
 21 cm/8¼"

4.5 mm  
**OC369.25**  
 25 cm/10"

6 mm  
**OC372.17**  
 17 cm/6¾"

6 mm  
 LANE  
**OC372.25**  
 25 cm/10"

6 mm  
**OC378.25**  
 25 cm/10"

PHILIPS  
**OC380.25**  
 25 cm/10"





## Bone Surgery (Hand Surgery)

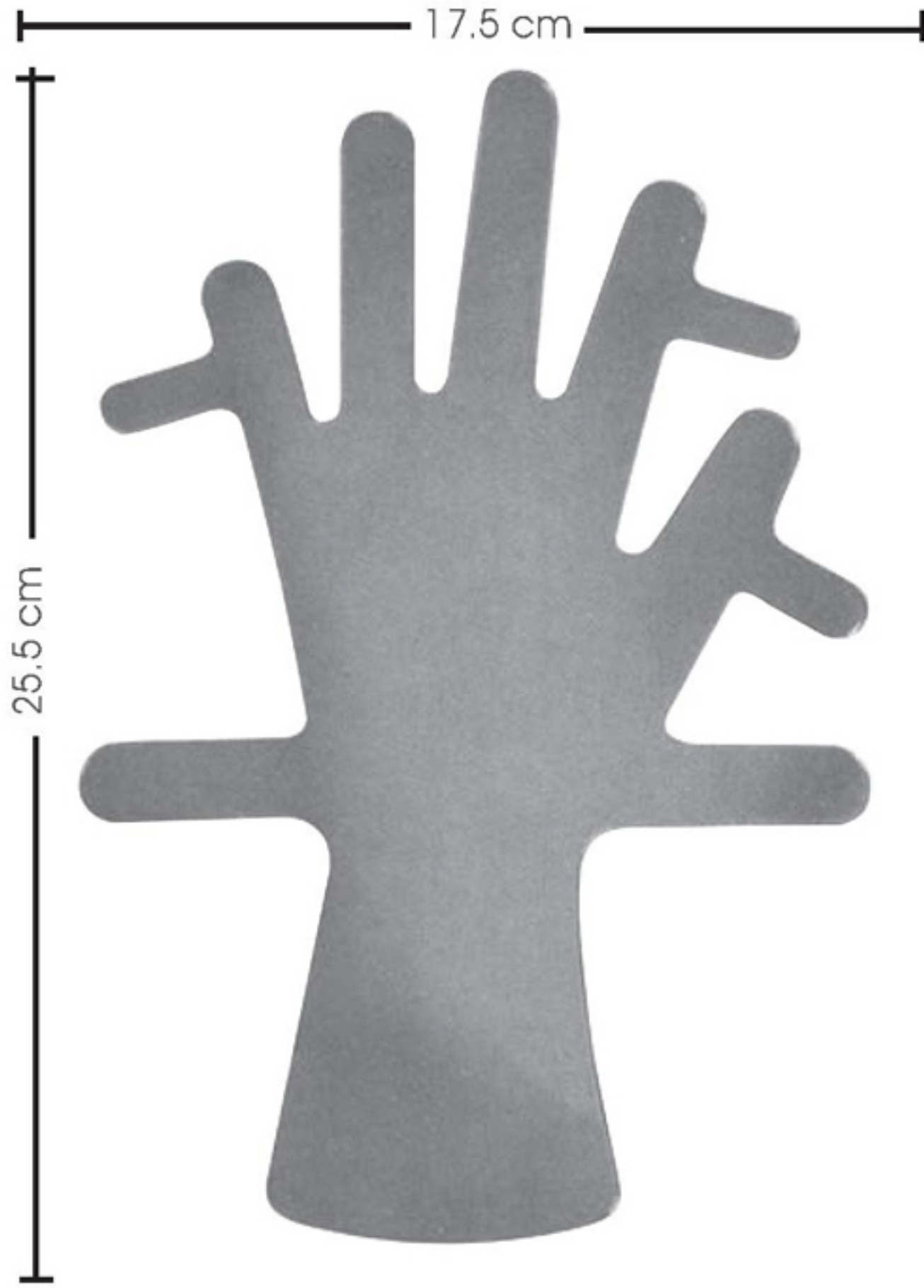

**OC960.58**

Çocuklar için el sabitleyici, yumuşak  
Children's hand control, soft

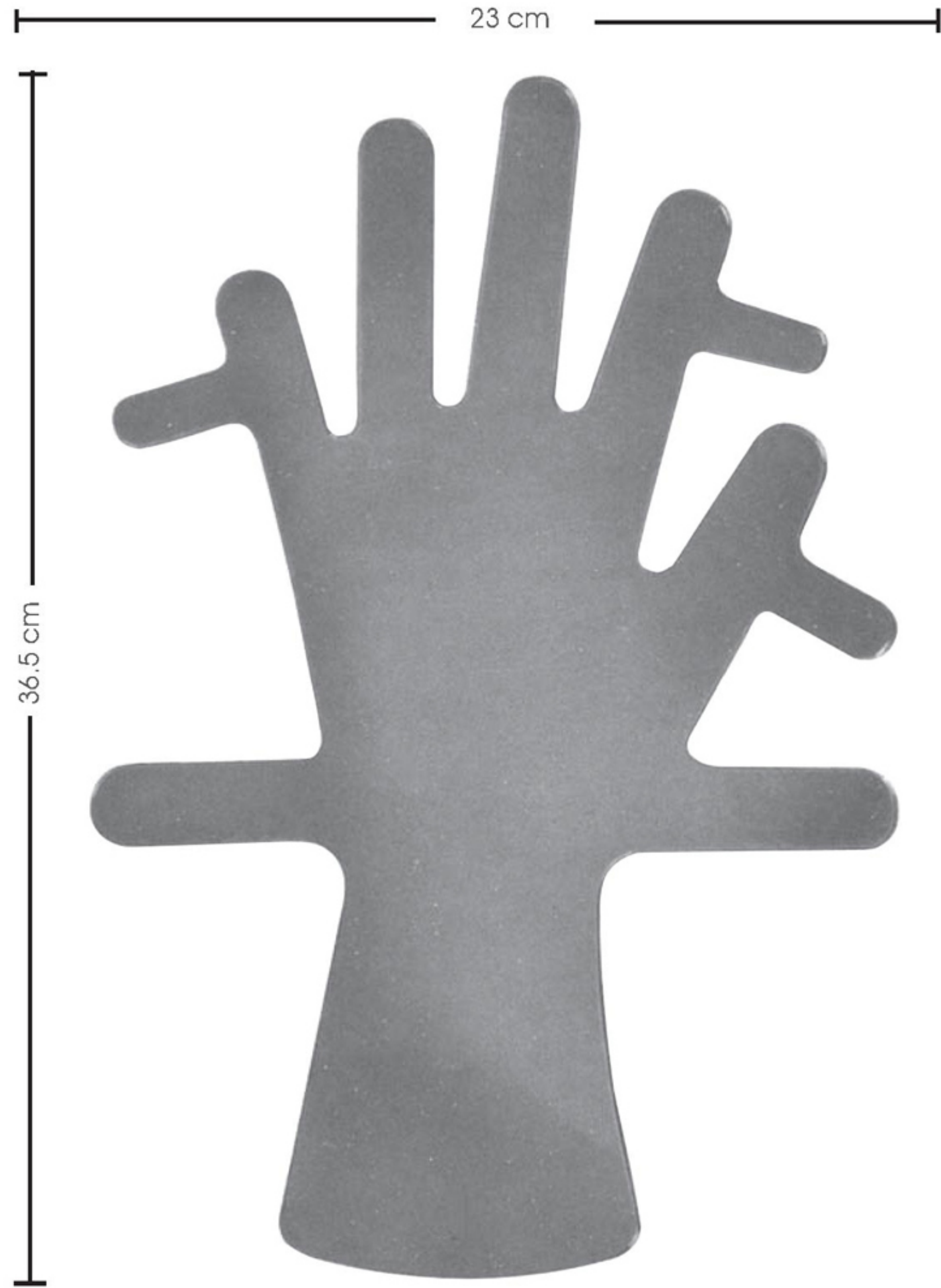

**OC960.59**

Yetişkinler için el sabitleyici, yumuşak  
Used stabilizer for adults, soft



**OC960.60**