

Our Scalers

Compare our scalers and curettes with the best in the industry and you will immediately recognize we are equal in every way but one... price. Note the deep precision knurling for better tactile feel. The same high-grade stainless steel tips, the same light weight (under 18 grams) for less hand fatigue, the same professional craftsmanship, and surpassing the highest industry standards. Of course, any manufacturer can make these claims, but we guarantee and certify ours.

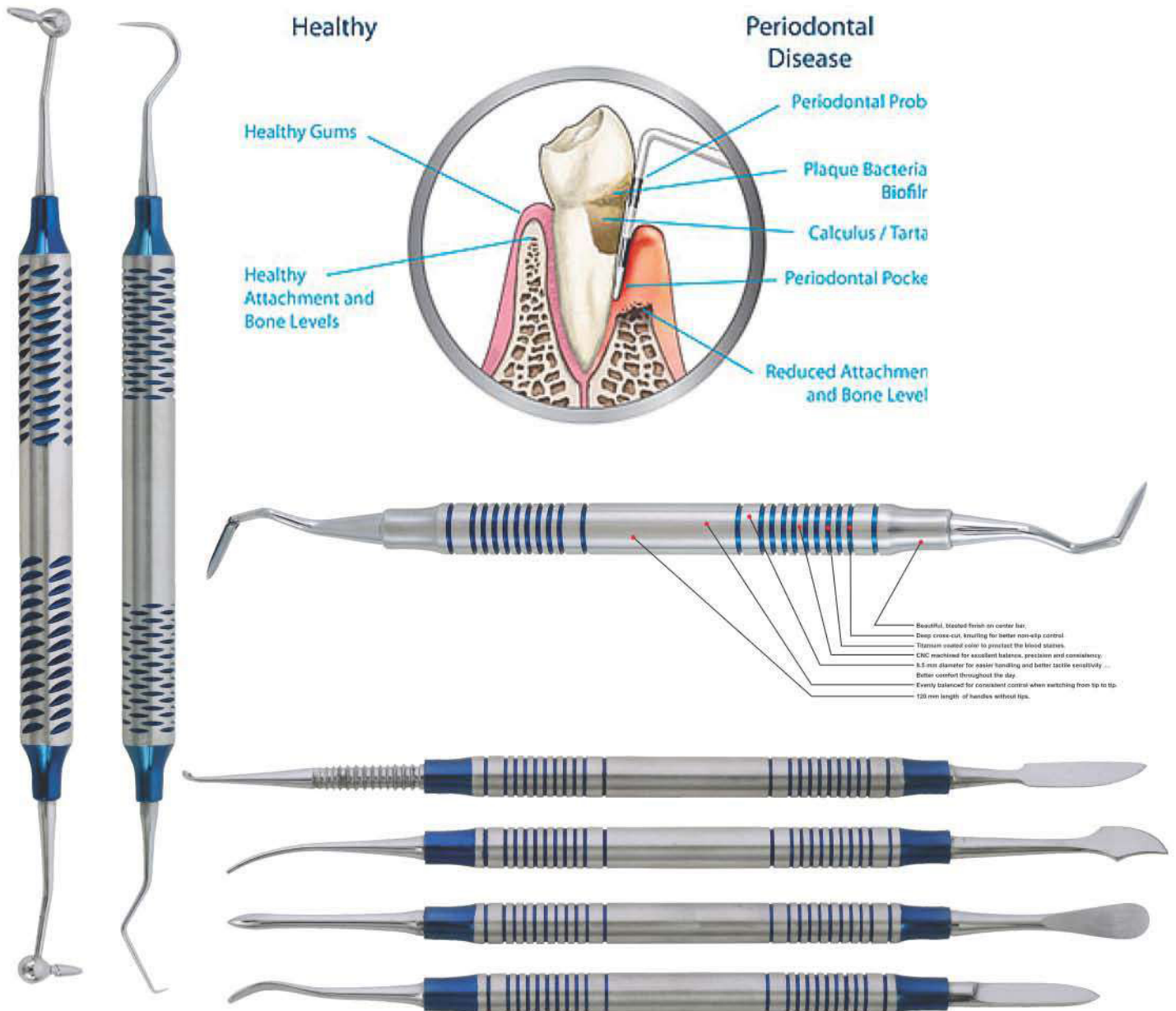

- High-polish mirror finish tips.
- Manufactured within the guidelines of the FDA quality assurance system for good manufacturing practices.
- Highest grade German stainless steel, razor sharp, durable tips. Rockwell hardened to 60 RHc.
- 27 of the most popular designs from graces to McCalls to columbias, and many european patterns.
- All instruments are guaranteed against defects in material and workmanship.

- All instruments bear the ce mark, emblematic of the european community's highest standards.
- Customer satisfaction guarantee, too!
- Less than 20 grams ... Lightweight for less hand fatigue.
- Manufactured to the most exacting standards so the 50th instrument you buy is exactly like your first.
- You decide ... Why pay more for the same high-quality instruments?

VALUED BUYERS

Compare our scalers and curettes with the best in the industry and you will immediately recognize we are equal in every way but one... price. Note the deep precision knurling for better tactile feel. The same high-grade stainless steel tips, the same light weight (under 20 grams) for less hand fatigue, the same professional craftsmanship, and surpassing the highest industry standards. Of course, any manufacturer can make these claims, but we guarantee and certify ours. We regularly manufacturing below articles in showing handles & pattern A to L for better grip & perfection. We are also fully equipped & capable to develop these instruments as per your own specific requirements & demands in materials, sizes, shapes and patterns.

**A-Hollow Handle Ø 10 mm****B-Hollow Handle Ø 10 mm****C-Hollow Handle Ø 10 mm****D-Hollow Handle Ø 10 mm****E-Hollow Handle Ø 10 mm****F-Hollow Handle Ø 10 mm****G-Hollow Handle Ø 10 mm****H-Hollow Handle Ø 6.4 mm****I-Hollow Handle Ø 8 mm****J-Hollow Handle Ø 10 mm****K-Soild Handle Ø 6 mm****L-Soild Handle Ø 6 mm**

MOUTH MIRRORS

- зеркала
- Espejos de la boca
- Mundspiegel
- дзеркала
- Miroirs à la bouche
- مرايا الفم

Plain



MD-600 Fig. 3 Ø20mm
MD-601 Fig. 4 Ø22mm
MD-602 Fig. 5 Ø24mm
MD-603 Fig. 6 Ø26mm



Cone-Socket Plain



MD-604 Fig. 3 Ø20mm
MD-605 Fig. 4 Ø22mm
MD-606 Fig. 5 Ø24mm

Magnifying



MD-607 Fig. 3 Ø20 mm
MD-608 Fig. 4 Ø22 mm
MD-609 Fig. 5 Ø24 mm



Cone-Socket Magnifying



MD-610 Fig. 3 Ø20mm
MD-611 Fig. 4 Ø22mm
MD-612 Fig. 5 Ø24mm

Rhodium



MD-613 Fig. 3 Ø20mm
MD-614 Fig. 4 Ø22mm
MD-615 Fig. 5 Ø24 mm



Cone-Socket Rhodium



MD-616 Fig. 3 Ø20mm
MD-617 Fig. 4 Ø22mm
MD-618 Fig. 5 Ø24mm

Front Surface



MD-619 Fig. 3 Ø20mm
MD-620 Fig. 4 Ø22mm
MD-621 Fig. 5 Ø24mm
MD-622 Fig. 6 Ø26mm



Cone-Socket Front Surface



MD-623 Fig. 3 Ø20mm
MD-624 Fig. 4 Ø22mm
MD-625 Fig. 5 Ø24mm

HANDLES FOR MOUTH MIRRORS

- Ручки для зеркал
- Manches pour miroirs à bouche
- Mundspiegelgriffe
- Ручки для дзеркал
- Mangos para espejos de boca
- مقابض لمرآيا الفم



MD-626
 Hollow Mirror
 Handle Round
 Ø 10 mm



MD-627
 Hollow Mirror
 Hexagonal
 Handle
 Ø 8 mm



MD-628
 Hollow
 Ø 8 mm



MD-629
 Hollow Mirror
 Hexagonal
 Handle
 Ø 10 mm



MD-630
 Hollow Mirror
 Handle
 Ø 8 mm



MD-631
 Hollow Mirror
 Handle
 Ø 10 mm



MD-632
 Mirror Handle
 Solid
 Ø 6 mm



MD-633
 Mirror Handle
 Solid
 Ø 6 mm



MD-634
 Mirror Handle
 Solid Octagonal
 Ø 6 mm



MD-635
 Mirror Handle
 Stem
 with Rule
 35mm



MD-636
 Mirror Handle
 Solid
 Stem with
 Rule 35mm



MD-637
 Cone-Socket
 Solid Octagonal
 Ø 6 mm



MD-638
 Cone-socket
 Solid
 Ø 6 mm



MD-639
 Cone-socket
 Hexagonal
 Handle
 Ø 6 mm

Cone-Socket Mirror Handle

EXPLORERS

- Зонды
- Sondes
- Zahnsonden

- Зонди
- Sondas
- المستكشفين

Examination kit Set of 3 Pieces



MD-640
Probe

MD-641
Mirror

MD-642
College Forcep
15cm



Examination Set of 4 Pieces



MD-643
Exp,23/17-A

MD-644
Excavators

MD-645
Tweezers

MD-646
Mouth Mirror

MD-647

First Aid Examination Set of 3 Pieces



MD-648

First Aid Examination Set of 3 Pieces



MD-649

First Aid Examination Set of 3 Pieces



MD-650

First Aid Examination Set of 3 Pieces



TWEEZERS

- Пинцеты
- Précelles - Brucelles
- Zahnpinzetten

- Пинцети
- Pinzas para algodón
- ملاقط



MD-651
Surgical
11.5cm



MD-652
London College
15cm



MD-653
Semken Taylor
Str.



MD-654
Semken Taylor
Cvd.



MD-655
Meriam
16cm



MD-656
Dressing
14cm



MD-657
Semken Taylor
1x2 Straight



MD-658
Semken Taylor
1x2 Curved



MD-659
Gilles
15cm 1x2



MD-660
14cm 1x2



MD-661
Perry
13cm



MD-662
Atraumatic
15cm Cvd.



MD-663
Atraumatic
15cm Str.



MD-664
College with Lock
15cm Cvd.



MD-665
Gerald
17.5cm



MD-666
with lock
15cm



MD-667
Atraumatic
17.5cm

TWEEZERS

- Пинцеты
- Précelles - Brucelles
- Zahnpinzetten

- Пинцети
- Pinzas para algodón
- ملاقط



MD-668
Adson-TC
12cm



MD-669
Adson-TC
12cm 1x2



MD-670
Adson-TC
15cm 1x2



MD-671
Adson
12cm



MD-672
Adson
12cm 1x2



MD-673
Adson
15cm 1x2



MD-674
Adson Brown
12cm



MD-675
Crane Kaplan
15cm



MD-676
Crane Kaplan
15cm



MD-677
Crane Kaplan
15cm



MD-678
Hemingway
15cm



MD-679
Miller
15cm Str.



MD-680
Miller
15cm Cvd.



MD-681
Dressing
Tweezer
14.5cm



MD-682
College
Curved
Tip 15cm



MD-683
Maryam
Tweezers
15cm



MD-684
College
Tweezer
15cm



MD-685
Perry
Tweezer
12.5cm



MD-686
Self-locking
Tweezer
15cm

EXPLORERS

- Зонды
- Sondes
- Zahnsonden
- Зонди
- Sondas
- المستكشفين

Single Ended Probe Solid Handle 4.5mm Length 150mm

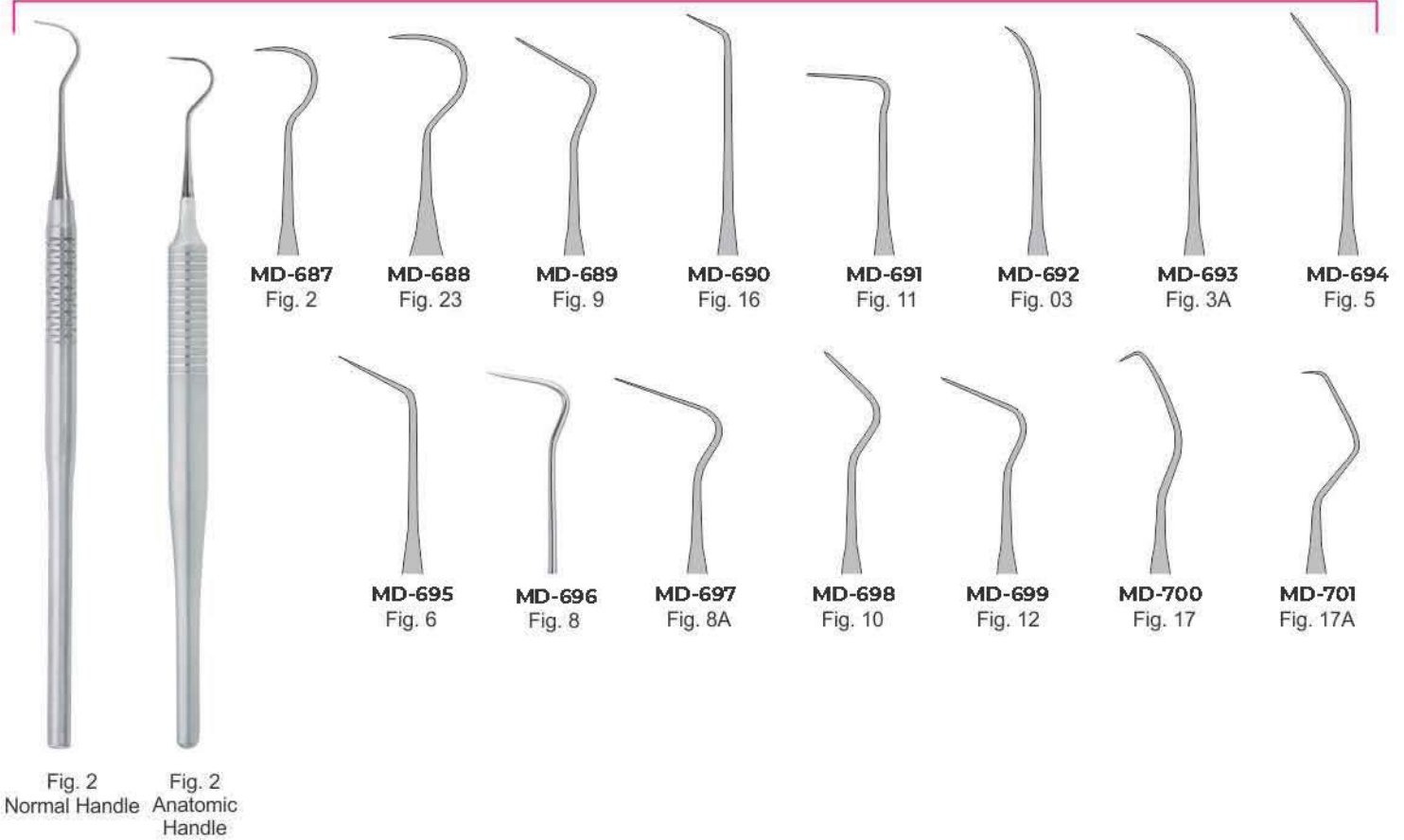

Explorers-Single-End

Double-Ended Explorers

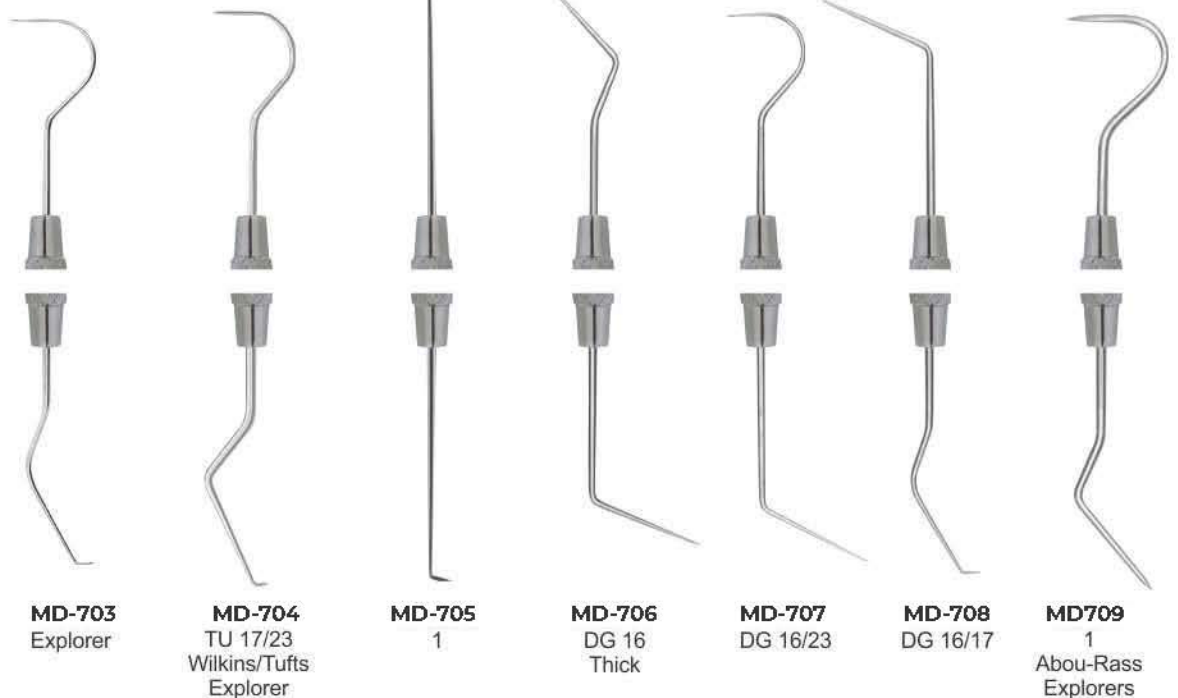

- Зонды
- Sondes
- Zahnsonden
- Зонди
- Sondas
- المستكشفين

Probes Double Ended 6mm, length 170mm



MD-710
Williams



MD-711
23/UNC1
university of north
carolina Explorer



MD-712
Goldman Fox
Fig.17



MD-713
University
of Michigan
Fig.17



MD-714
Williams
Fig.17



MD-715
Goldman Fox
Fig.16



MD-716
University
of Michigan
Fig.16



MD-717
Williams
Fig.16

Pointed Probes Double Ended Handle 6mm, length 170mm



MD-718
Goldman Fox
Williams



MD-719
Goldman Fox
Merrit B



MD-720
Goldman Fox
University of
Michigan



MD-721
University
of Michigan
Fig.23



MD-722
Williams
Fig.23

EXPLORERS

- Зонды
- Sondes
- Zahnsonden
- Зонди
- Sondas
- المستكشفين

EXPLORERS INSTRUMENTS SOLID HANDLE 6MM, LENGTH 170MM

PLUGGERS



| | | | |
|---|---|---|---|
| MD-724 5/7 21mm | MD-725 9/11 21mm | MD-726 1/2 Root Canal Plugger | MD-727 3/4 Root Canal Plugger |
| MD-723 1/3 21mm | MD-728 MA57 27mm | MD-729 GP3 30mm | |
| MD-730 ISO Size 30 24mm | MD-731 ISO Size 40 24mm | MD-732 ISO Size 50 24mm | MD-733 ISO Size 60 24mm |

PERIODONTAL PROBES

- Зонды пародонтологические
- Sondes parodontales
- sonde parodontall
- зонди пародонтологічні
- Sondas parodontales
- المسابير اللثة

SPREADERS

HEAT CARRIERS

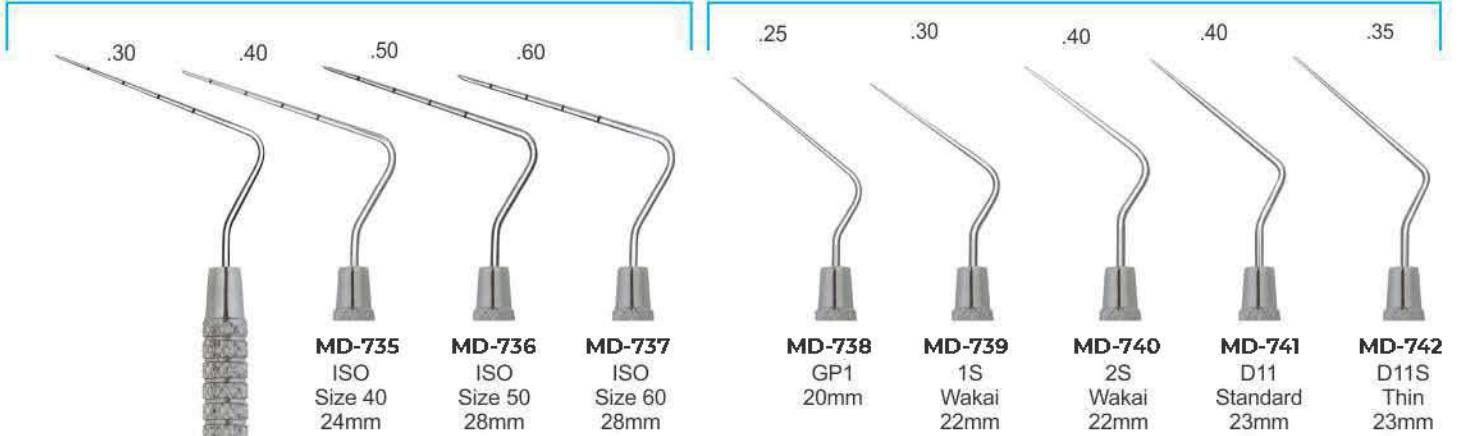

HEAT CARRIERS

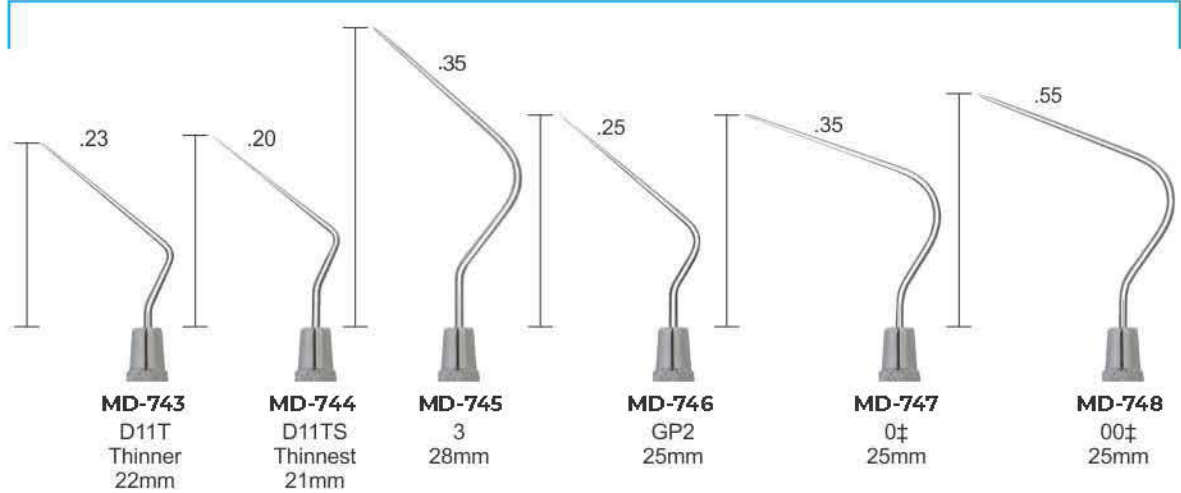

MD-734
ISO
Size 30
24mm

- Зонды пародонтологические
- Sondes paradontales
- sonda paradontali
- зонди пародонтологічні
- Sondas paradontales
- المسابر اللثة

ENDODONTICS INSTRUMENTS

ANTERIOR



MD-749
8A
29mm

MD-750
8 1/2A
29mm

MD-751
9A
29mm

MD-752
9 1/2A
29mm

MD-753
10A
29mm

MD-754
10 1/2A
29mm

MD-755
11A
29mm

MD-756
11 1/2A
29mm

MD-757
12A
29mm

LUKS



MD-758
L1
18mm

MD-759
L2
18mm

MD-760
L3
18mm

MD-761
L4
18mm



MD-762
Gracey Curettes 1/2



MD-763
Gracey Curettes 3/4



MD-764
Gracey Curettes 5/6



MD-765
Gracey Curettes 7/8



MD-766
Gracey Curettes 9/10



MD-767
Gracey Curettes 11/12



MD-768
Gracey Curettes 13/14



MD-769
Gracey Curettes 1/2



MD-770
Gracey Curettes 3/4



MD-771
Gracey Curettes 5/6



MD-772
Gracey Curettes 7/8



MD-773
Gracey Curettes 9/10

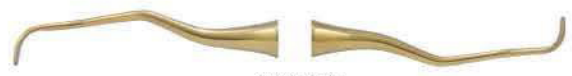

MD-774
Gracey Curettes 11/12



MD-775
Gracey Curettes 13/14



GRACEY MINI FIVE

Hollow Handle 9.5mm, Length 170mm Ceramic Coated Handle



MD-777
Fig. 3/4 Gracey 3M



MD-778
Fig. 5/6 Gracey 3M



MD-779
Fig. 7/8 Gracey 3M
Buccal and lingual/
Palatal surfaces



MD-780
Fig. 11/12 Gracey 3M
Mesial



MD-781
Fig. 13/14 Gracey 3M
Distal



MD-776
Fig. 1/2
Gracey 3m

GRACEY AFTER FIVE

Hollow Handle 9.5mm, Length 170mm Ceramic Coated Handle



MD-783
Gracey 3/4 AF



MD-784
Gracey 5/6 AF



MD-785
Gracey 7/8 AF



MD-786
Gracey 11/12 AF



MD-787
Gracey 13/14 AF



MD-782
Gracey
1/2 AF



Gracey Curettes



$\frac{3...1}{3...1} | \frac{1...3}{1...3}$ **MD-788** Fig. 1/2 GR - Gracey
Buccal surfaces



$\frac{5...1}{5...1} | \frac{1...5}{1...5}$ **MD-789** Fig. 3/4 GR - Gracey
Lingual/Palatal surfaces



$\frac{5...1}{5...1} | \frac{1...5}{1...5}$ **MD-790** Fig. 5/6 GR - Gracey



$\frac{8...4}{8...4} | \frac{4...8}{4...8}$ **MD-791** Fig. 7/8 GR - Gracey
Buccal and lingual/
palatal surfaces



$\frac{8...4}{8...4} | \frac{4...8}{4...8}$ **MD-792** Fig. 9/10 GR - Gracey
Buccal and lingual/
palatal surfaces more angled



$\frac{8...4}{8...4} | \frac{4...8}{4...8}$ **MD-793** Fig. 11/12 GR - Gracey
Mesial



$\frac{8...4}{8...4} | \frac{4...8}{4...8}$ **MD-794** Fig. 13/14 GR - Gracey
Distal



$\frac{8...4}{8...4} | \frac{4...8}{4...8}$ **MD-795** Fig. 15/16 GR - Gracey
Mesial



$\frac{8...4}{8...4} | \frac{4...8}{4...8}$ **MD-796** Fig. 17/18 GR - Gracey
Distal

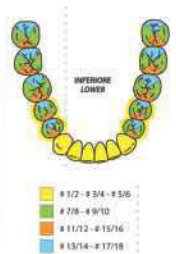
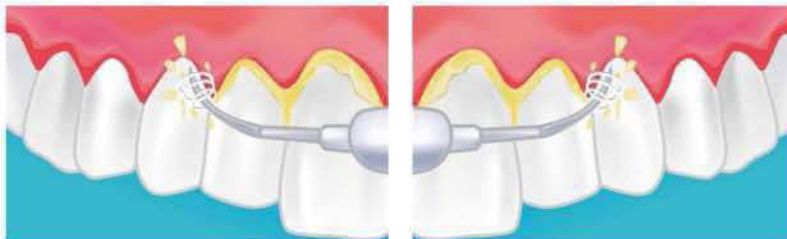
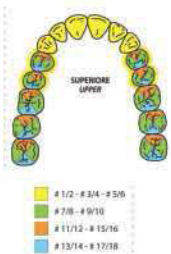

Sickle Scalers



MD-797 Fig. U15/33 - Towner-Jaquette



MD-798 Fig. U15/30 - Towner-Jaquette



MD-799 Fig. H5/33



MD-800 Fig. H6/H7



MD-801 Fig. 30/33 - Jaquette



MD-802 Fig. T2/T3 - Taylor



MD-803 Fig. 204



MD-804 Fig. 204S



MD-805 Fig. 11/12 - MC - McCall
Mesial



MD-806 Fig. 13/14 - MC - McCall
Distal

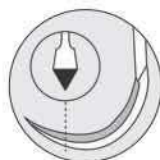
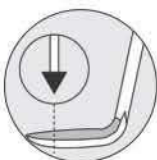

Straight and curved sickle scalers
Feature: 2 cutting edges curved facial component tipped ends

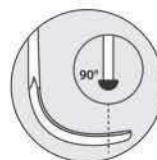

Universal curettes
are characterized by an angle of 90° between the terminal stem and the cutting component.

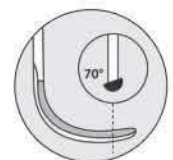

Gracey curettes
are characterized by an angle of 70° between the terminal stem and the cutting component.

Universal Curettes



MD-807 Fig. 13S/14S - MC - McCall



MD-808 Fig. 17S/18S - MC - McCall
Distal



MD-809 Fig. M23



MD-810 Fig. 204SD



MD-811 Fig. YG7/8-Younger Good



MD-812 Fig. L 1/2 - Langer



MD-813 Fig. L 3/4 - Langer



MD-814 Fig. L 5/6 - Langer



MD-815 Fig. M 23A



MD-816 Fig. M 23B

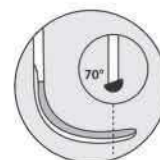
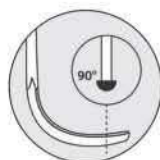
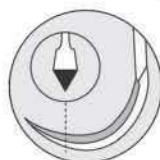
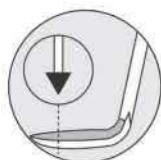

Straight and curved sickle scalers
Feature: 2 cutting edges curved facial component tipped ends

Universal curettes
are characterized by an angle of 90° between the terminal stem and the cutting component.

Gracey curettes
are characterized by an angle of 70° between the terminal stem and the cutting component.

Periodontal knives



MD-817
7
Goldmann-Fox

MD-818
8
Goldmann-Fox

MD-819
11
Goldmann-Fox

MD-820
2
Ebnetter

MD-821
16K15
Kirkland

MD-822
1
Orban

MD-823
1
Guldener

MD-824
19
Mühlemann



MD-825
17



MD-826
17D



MD-827
54A
Mühlemann



MD-828
67



MD-829
37D



MD-830
8
Wiland



MD-831
8
Holz

0.9 MM



MD-832
9
Holz

0.7 MM

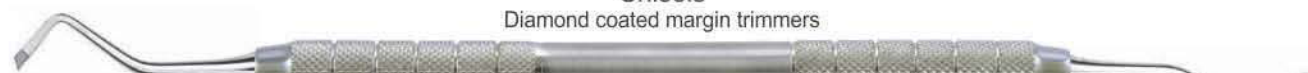

MD-833
40P

Chisels
Diamond coated margin trimmers



MD-834
40A

Thanks to the diamond-coated hand instruments the margins are evenly levelled.

Margin trimmers



MD-835
1TH2 Hirt



MD-836
5TH6 Hirt



MD-837
3TH4 Hirt



MD-838
7TH8 Hirt



MD-839
62NS61

2.0 mm



MD-840
37NS36

1.5 mm



MD-841
66NS65

1.0 mm



MD-842
79CI80 Black



MD-843
77CI78 Black



MD-844
279CI280 Black



MD-845
277CI278 Black



MD-846
179CI180 Black



MD-847
177CI178 Black

CHISELS



MD-848
1/2 Werdelstaedt



MD-849
3/4 Werdelstaedt



MD-850
7 Straight



MD-851
5/6 Straight



MD-852
7/10 Straight



MD-853
8/9 Binangle



MD-854
11/12 Binangle



MD-855
40/41 Binangle

Tartar Remover Instruments Solid Handle Ø 6 mm



MD-856
Fig. 1



MD-857
Fig. 1L
Left



MD-858
Fig. 1R
Right

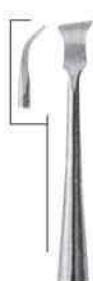

MD-859
Fig. 2L
left



MD-860
Fig. 2R
Right



MD-861



MD-862



MD-863



MD-864
WHITE 28



MD-865
WHITE 29



MD-866
WHITE 31



MD-867
WHITE 32



MD-868
WHITE 33



MD-869
WHITE 34

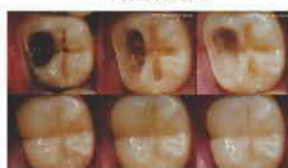

MD-870
WESTCOTT 21



MD-871
WESTCOTT 21B



MD-872



MD-873



MD-874
WHITE



MD-875
WHITE



MD-876



MD-877



MD-878



MD-879



MD-880



MD-881



MD-882



MD-883



MD-884



MD-885
PLANATOR



MD-886
PLANATOR



Ball Burnishers



Hatches



Spatulas rounded and sharp

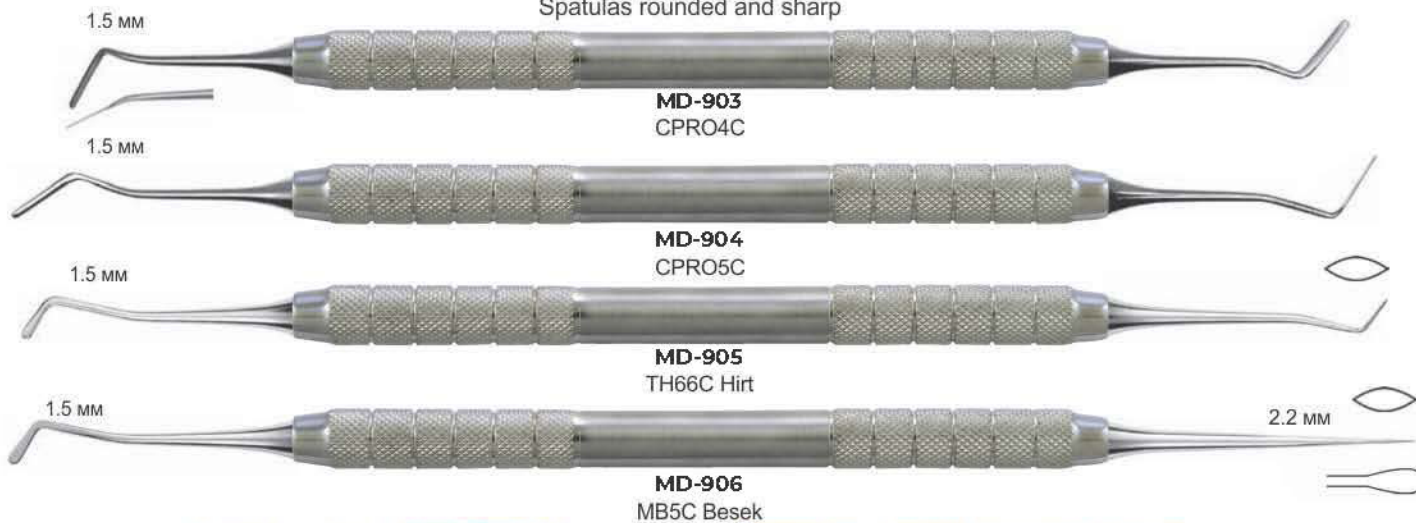

Spatulas Blade Thickness 0.22 mm

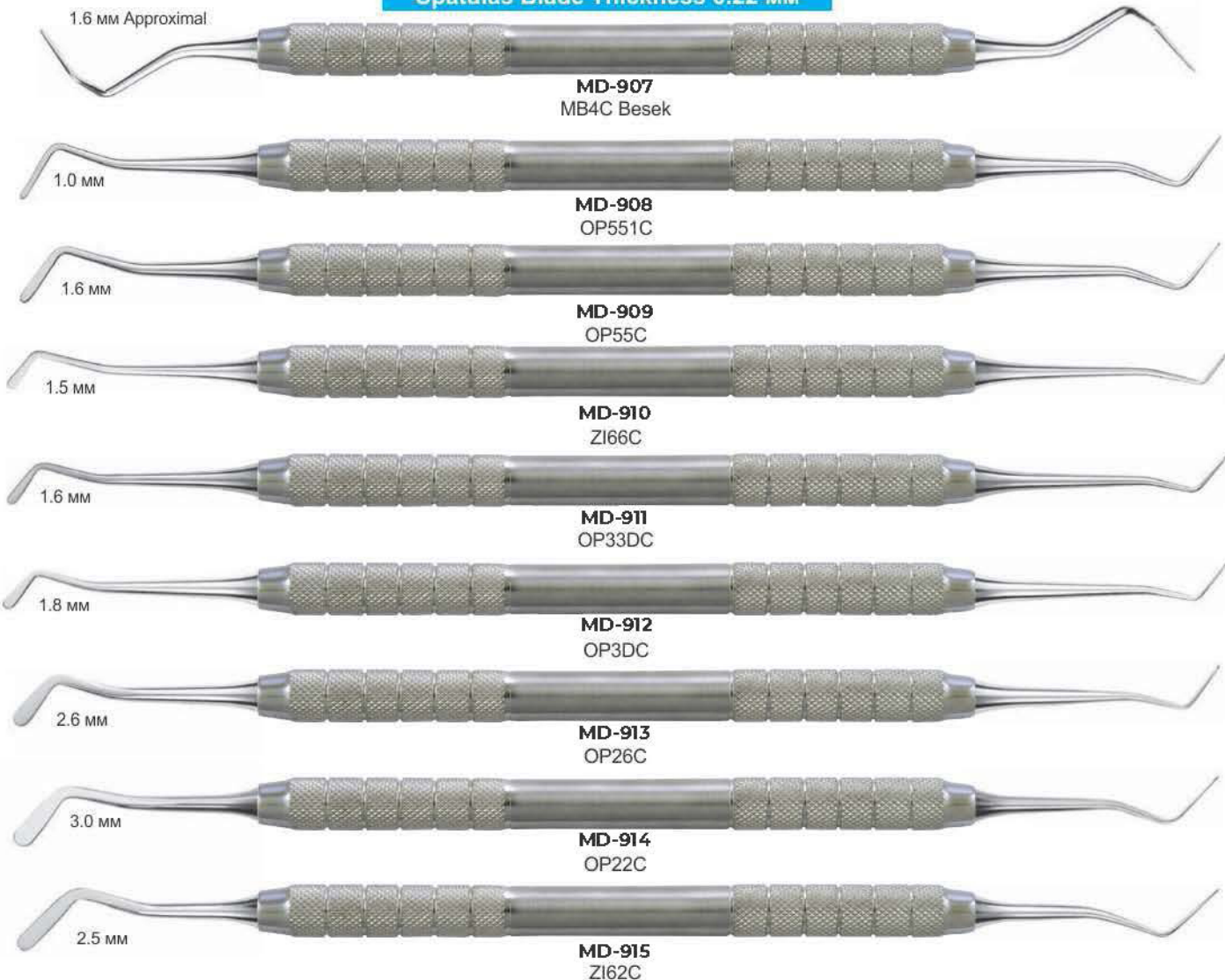

Spatulas

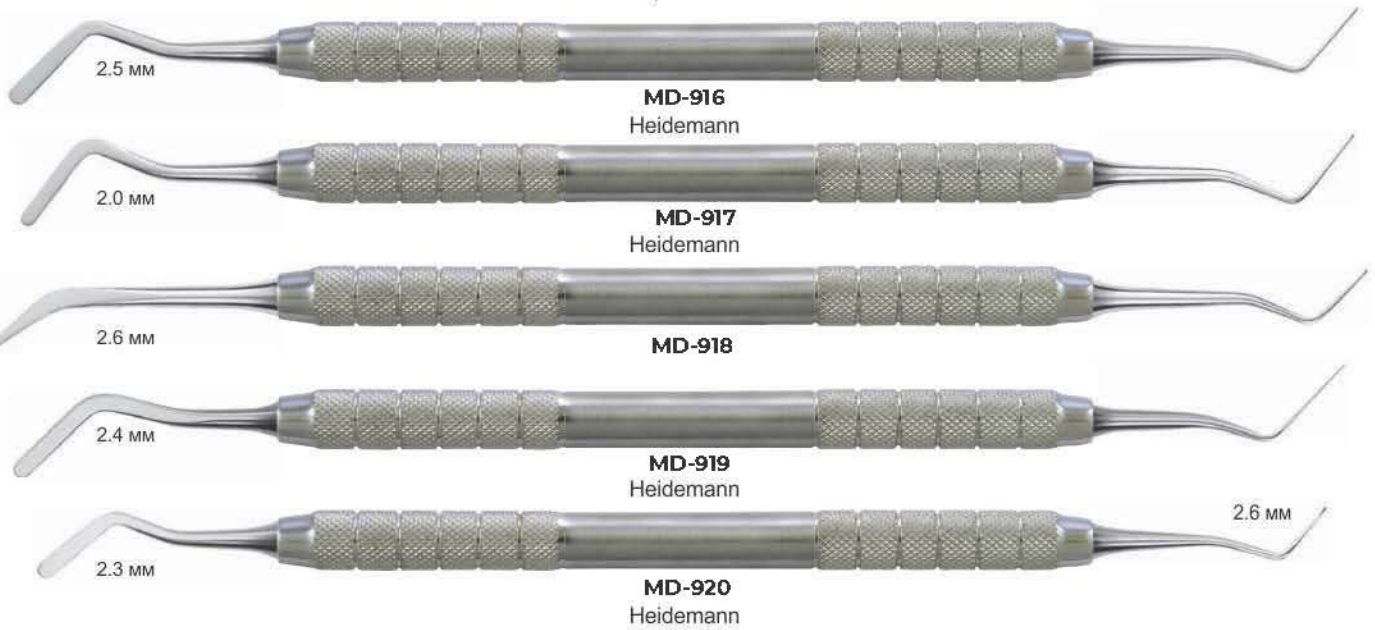

Spatulas-Pluggers



Water drop Our excavators have particularly sharp blades, free of burrs and perfectly rounded.

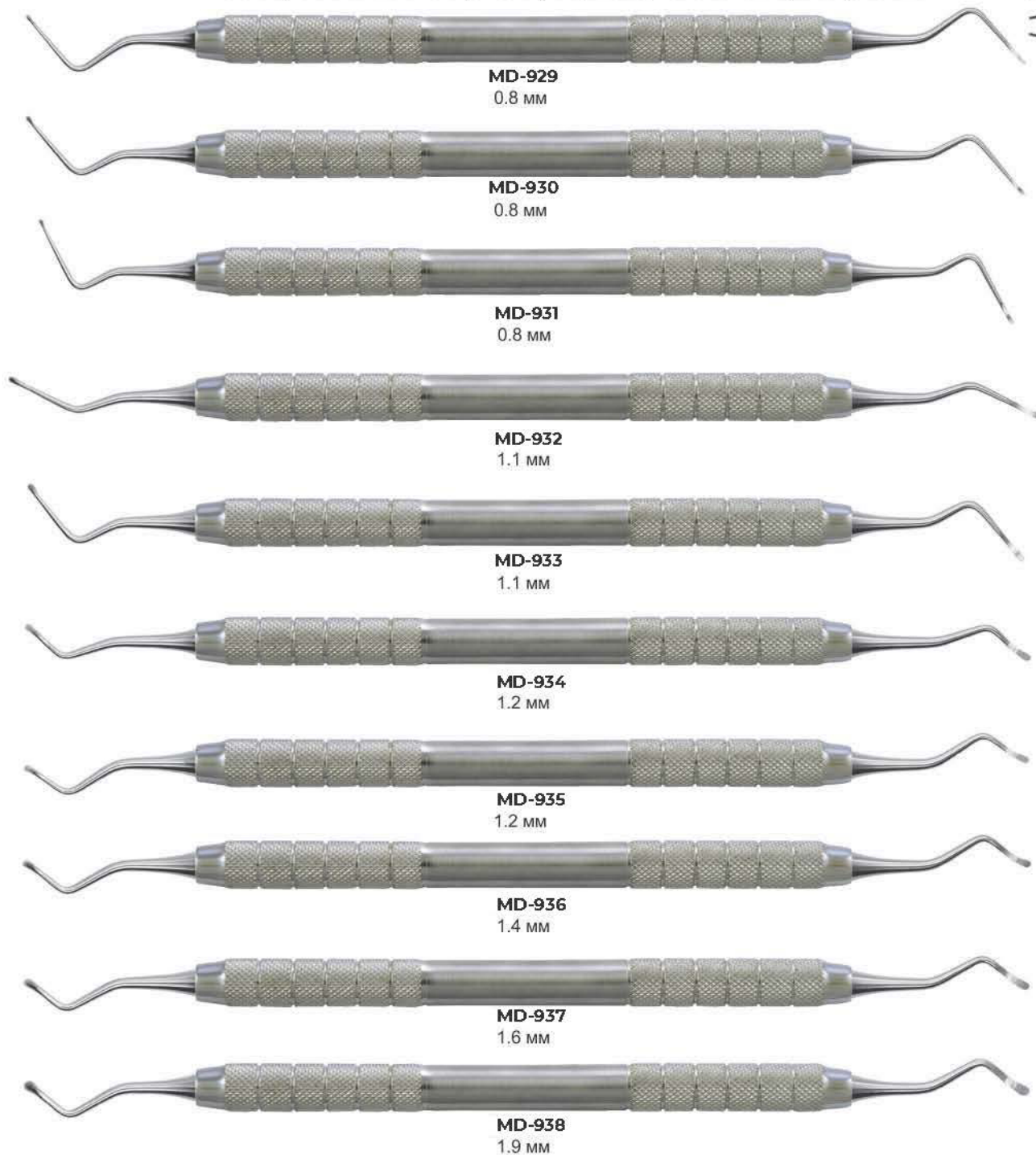



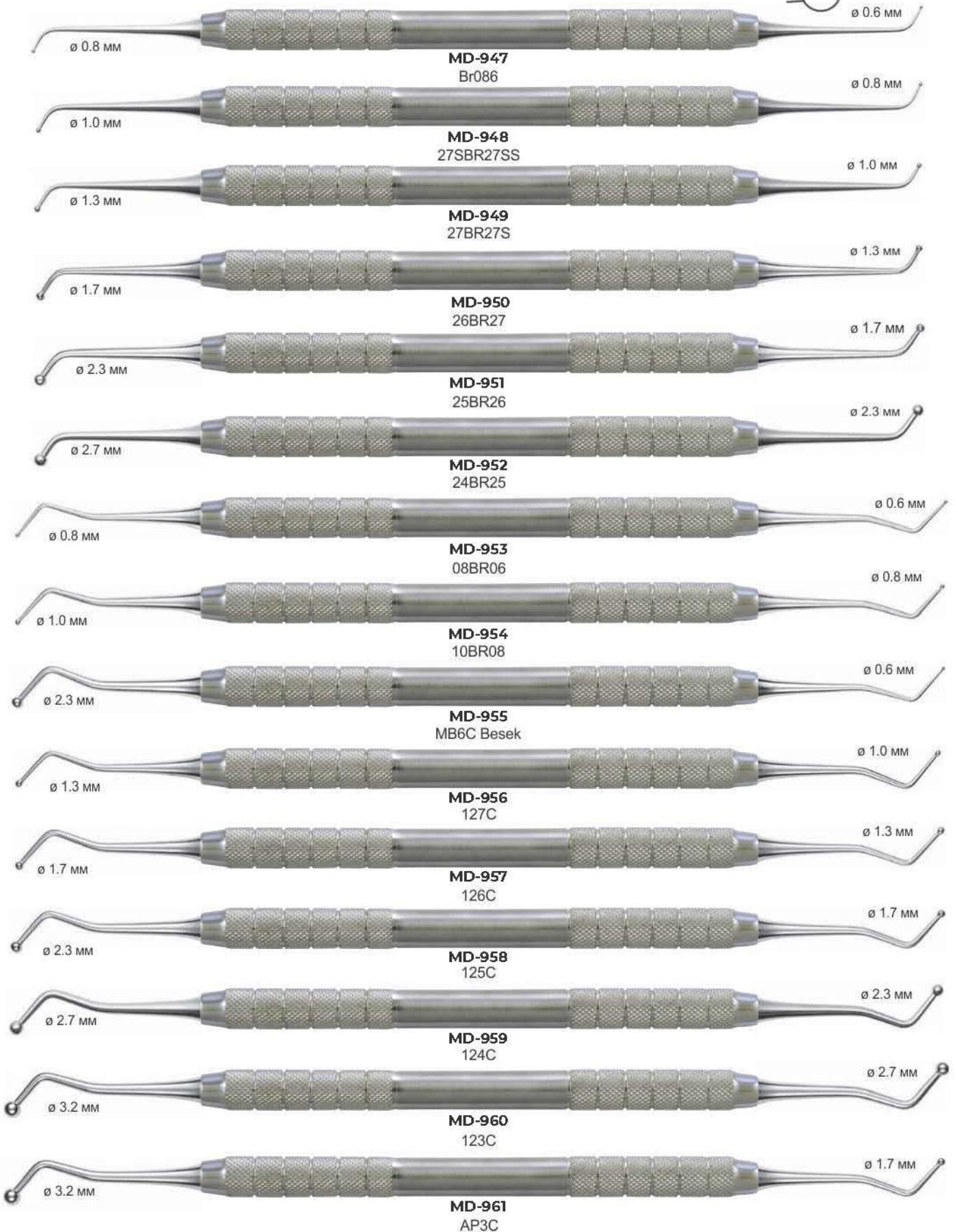
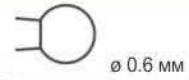



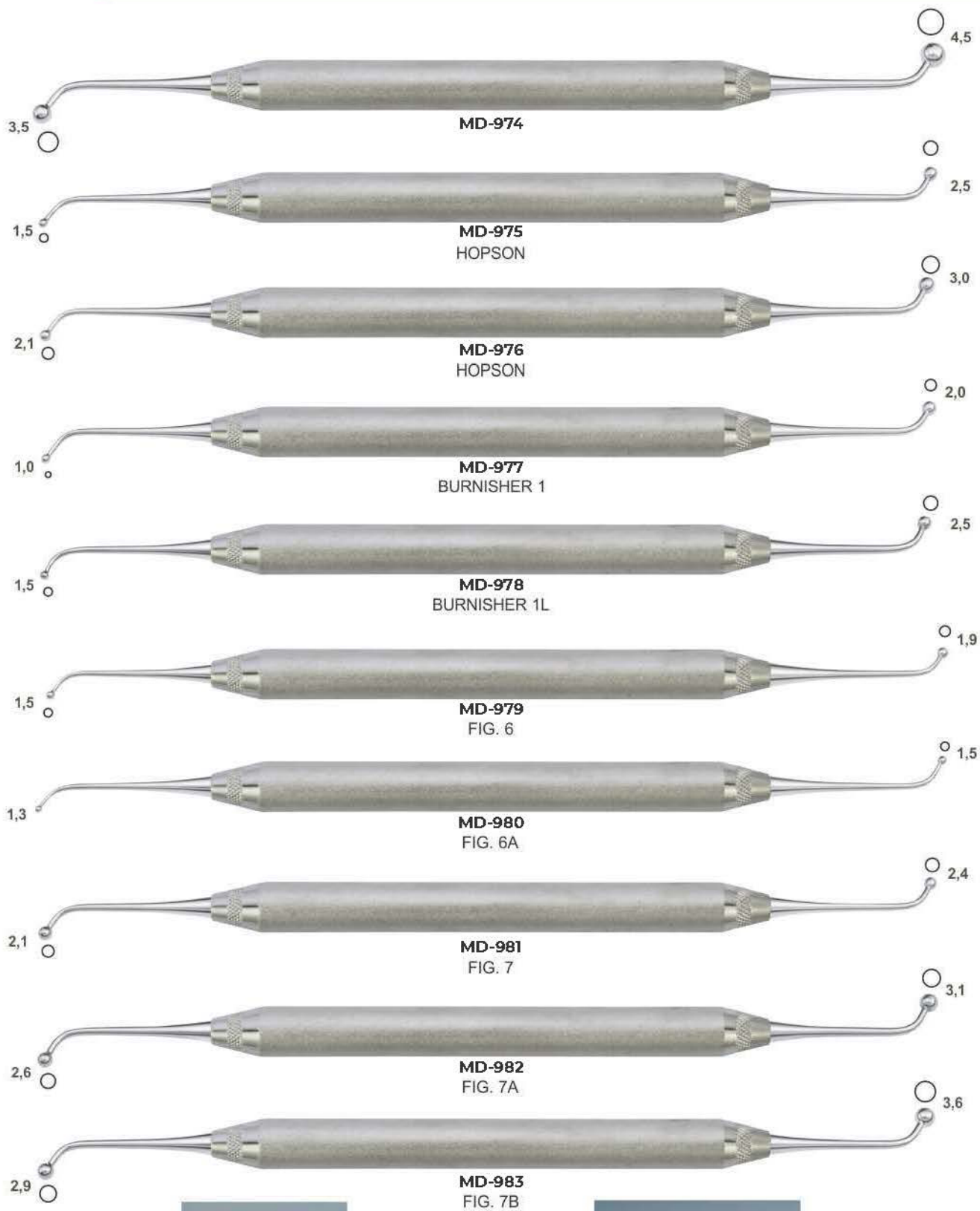



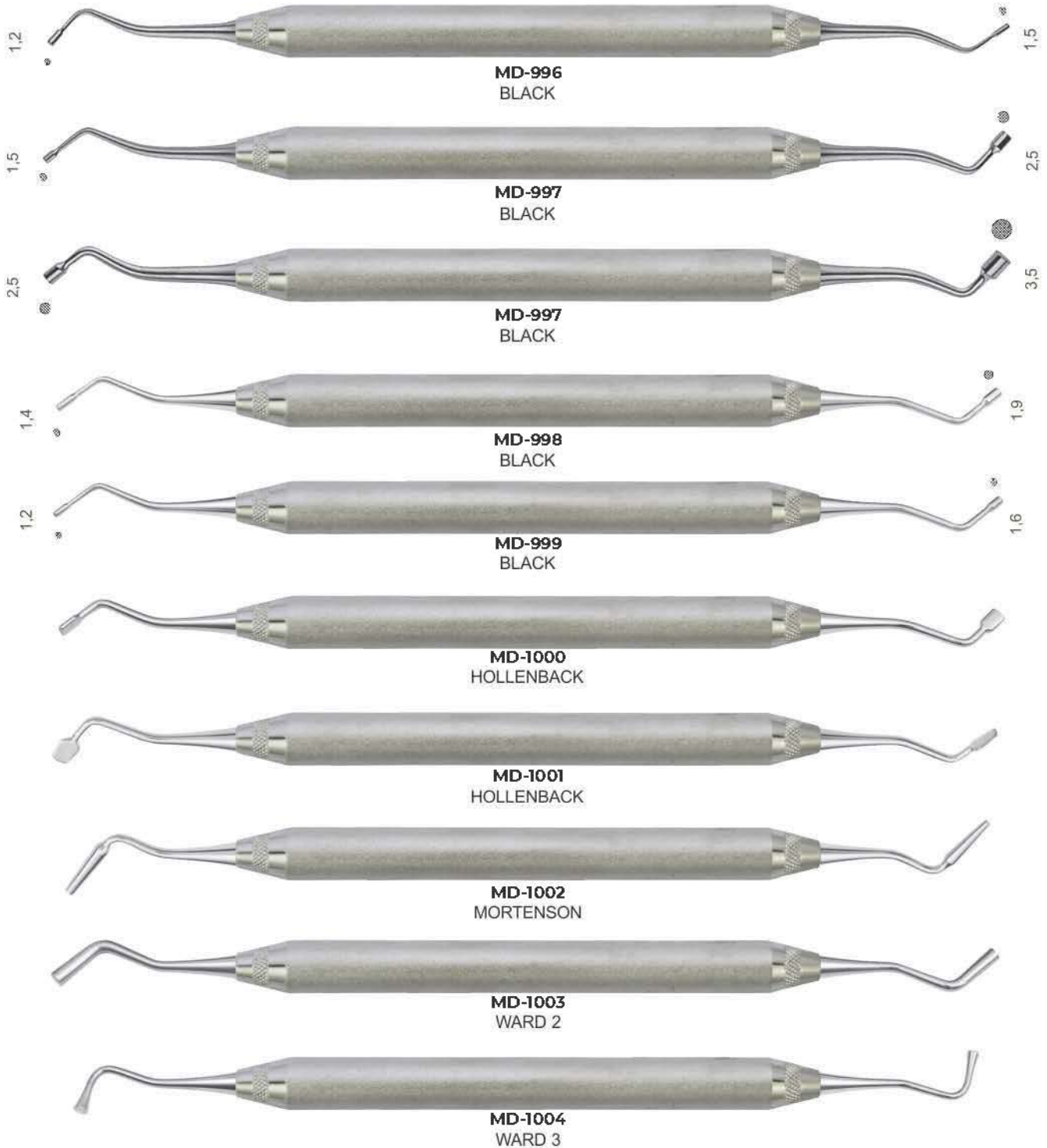



MD-1005
WILLIAMS



MD-1006
WILLIAMS



MD-1007
WILLIAMS



MD-1008



MD-1009



MD-1010



MD-1011



MD-1012



MD-1013



MD-1014

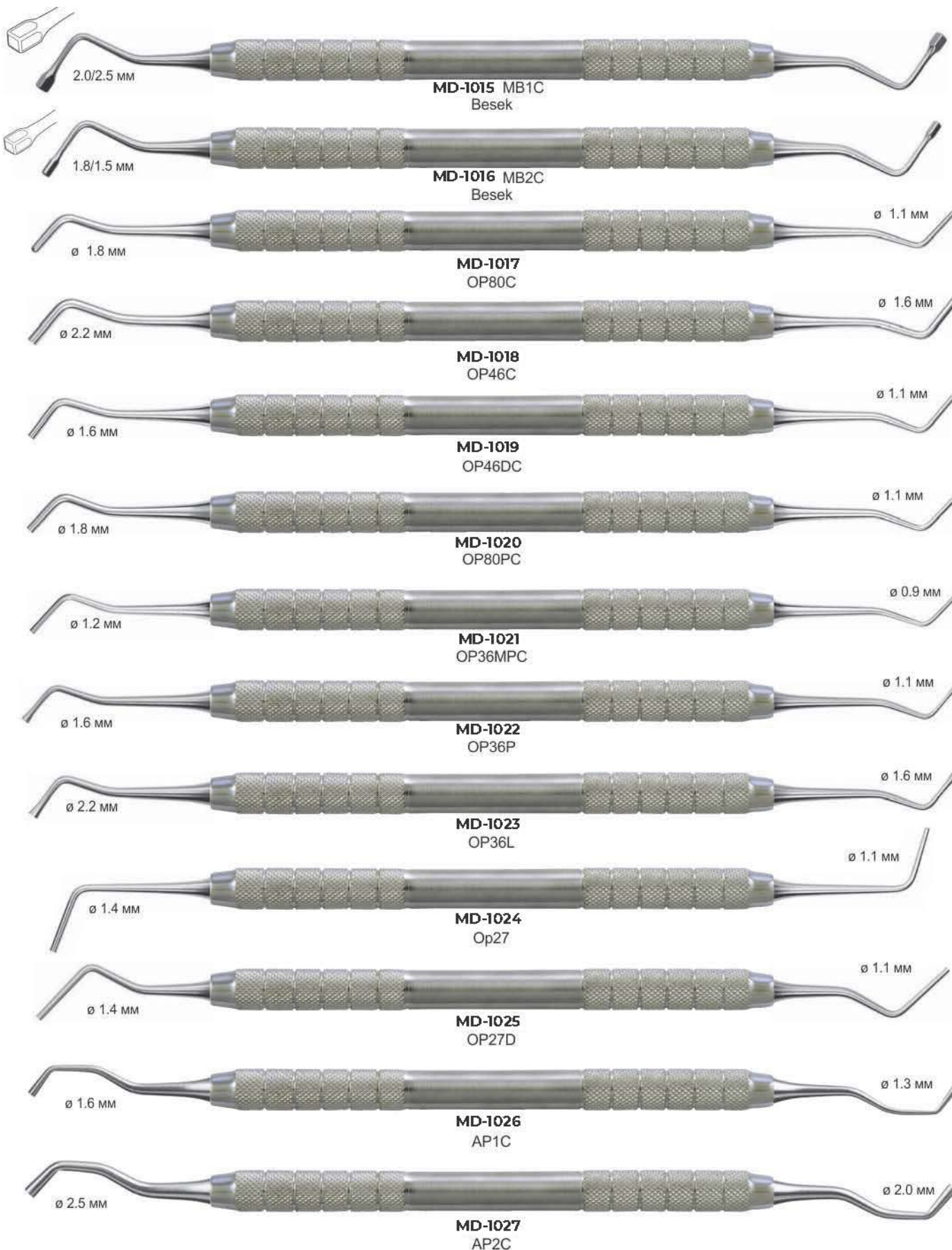

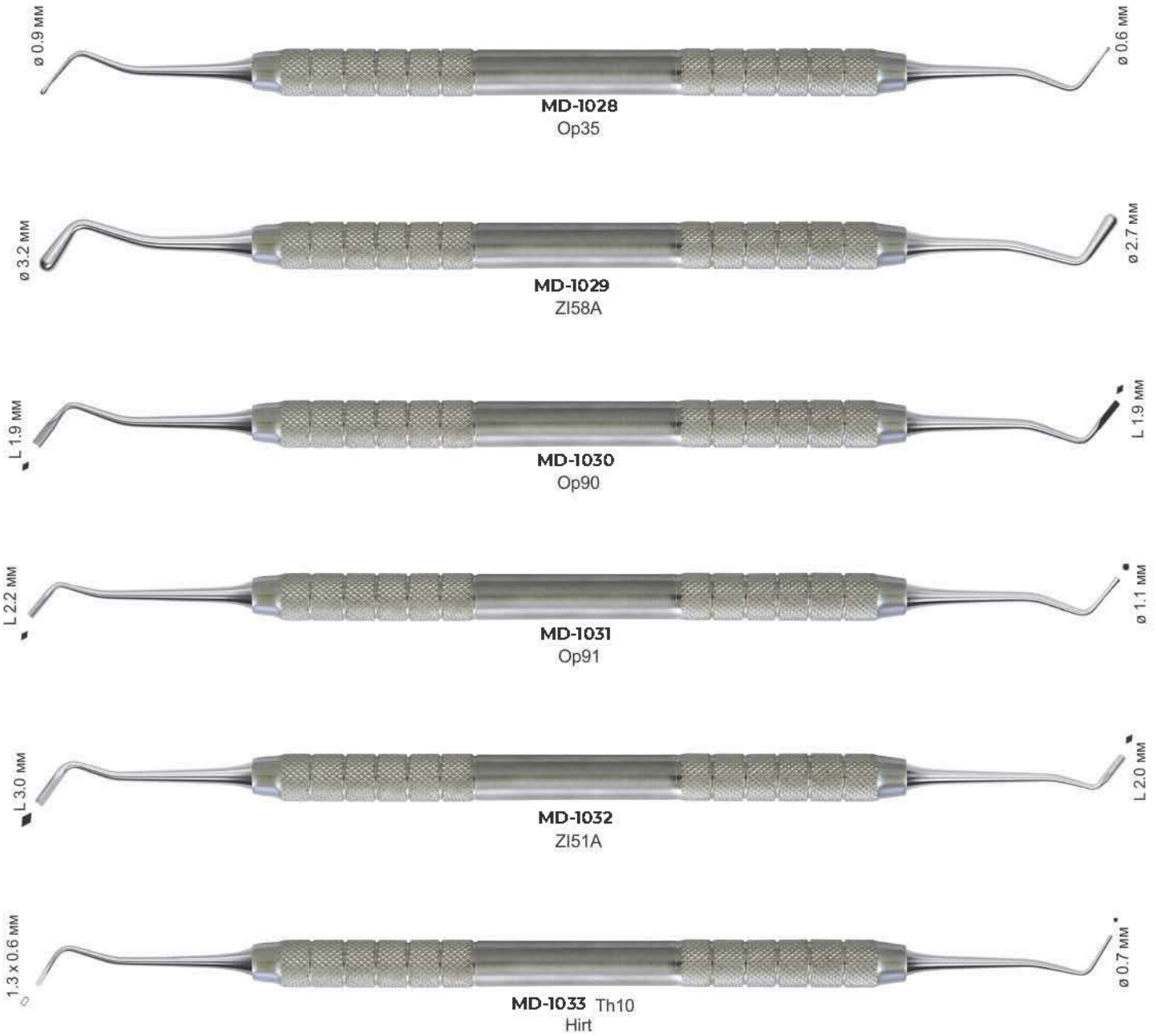

Serrated Pluggers

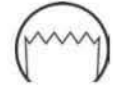

| | | | |
|----------|--|-------------------------|----------|
| Ø 0.9 MM | | MD-1034 OP36M | Ø 1.2 MM |
| Ø 1.1 MM | | MD-1035 OP36D | Ø 1.6 MM |
| Ø 1.6 MM | | MD-1036 Op36 | Ø 2.2 MM |
| Ø 1.0 MM | | MD-1037 Op52 | Ø 1.7 MM |
| Ø 2.2 MM | | MD-1038 Zi51 | Ø 2.6 MM |
| Ø 1.8 MM | | MD-1039 Op44 | Ø 2.2 MM |
| Ø 1.7 MM | | MD-1040 1BR2 | Ø 2.6 MM |
| Ø 2.6 MM | | MD-1041 2BR3 | Ø 3.6 MM |





MD-1042 MF2C
Fuzzi



MD-1043
Pj4



MD-1044 MB3C
Besek



MD-1045
HZ3C



MD-1046
CPRO3C



MD-1047 Mo1
Monari



MD-1048 TH28C
Hirt



MD-1049
HZ25C



MD-1050
Ck10



MD-1051
CK28BC



MD-1052 Op37
Carver



MD-1053
28BR29

Round excavators

Cariology

- for the removal of softened, carious dentin
- for the removal of temporary fillings

Surgery

- to sever the periodontal ligament prior to extraction
- for the removal of granulation tissue after extraction

Design: Round working end Curved cutting edge

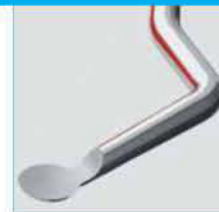

Round Excavator, 1.0 mm
MD-1054



Round Excavator, 1.5 mm
MD-1055



Round Excavator, 2.0 mm
MD-1056

Triple-angled back action excavators



Triple-angled Back Action Excavator, 1.0 mm
MD-1057



Triple-angled Back Action Excavator, 1.5 mm
MD-1058



Triple-angled Back Action Excavator, 2.0 mm
MD-1059



Triple-angled Back Action Excavator, 3.5 mm
MD-1060



FILLING INSTRUMENTS

- Инструменты для реставрации
- Instruments pour plombage
- Füllungsinstrumente (mit Kontrawinkel)
- Инструменти для реставрації
- Instrumentos para obturaciones
- ملء الصكوك

COMPOSITE/PLASTIC FILLING INSTRUMENTS SOLID HANDLE 6MM, LENGTH 170MM

BLACK

PLUGGERS/CONDENSERS

Hollenback

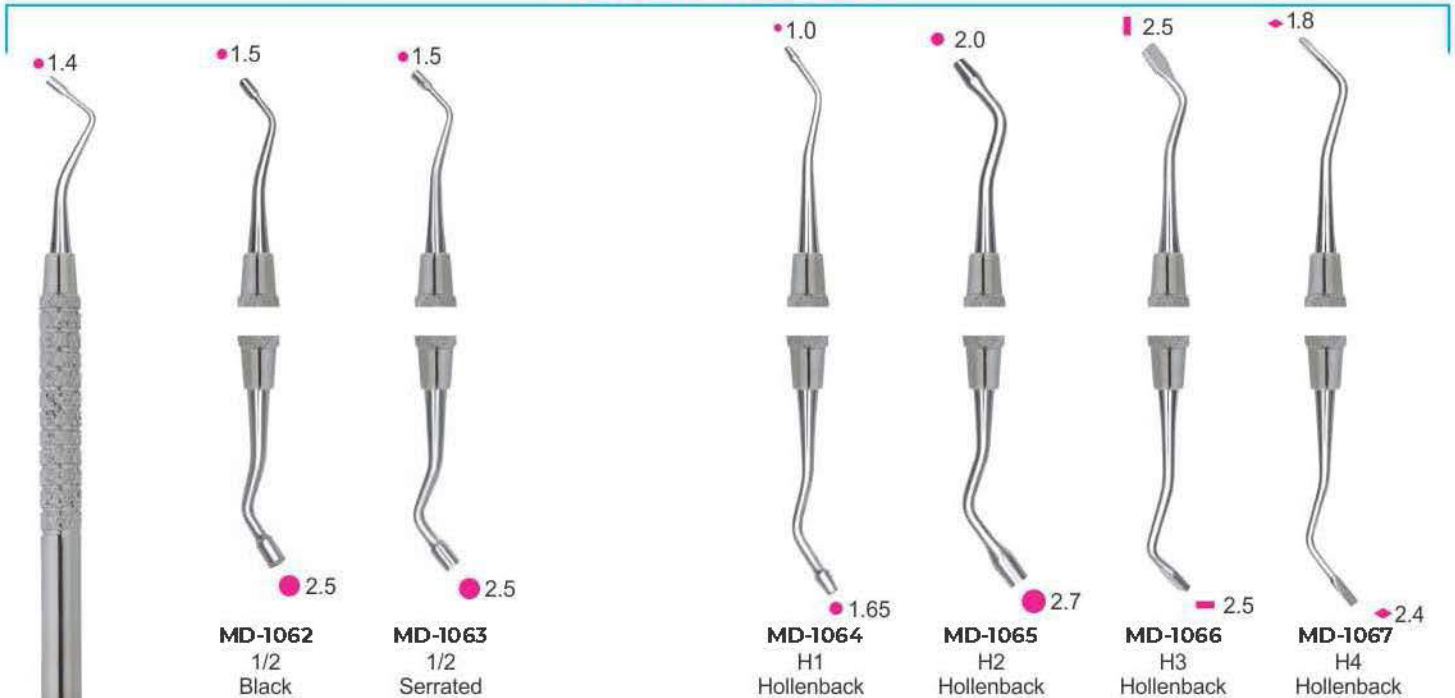

MARQUETTE CONDENSER

MORTONSON

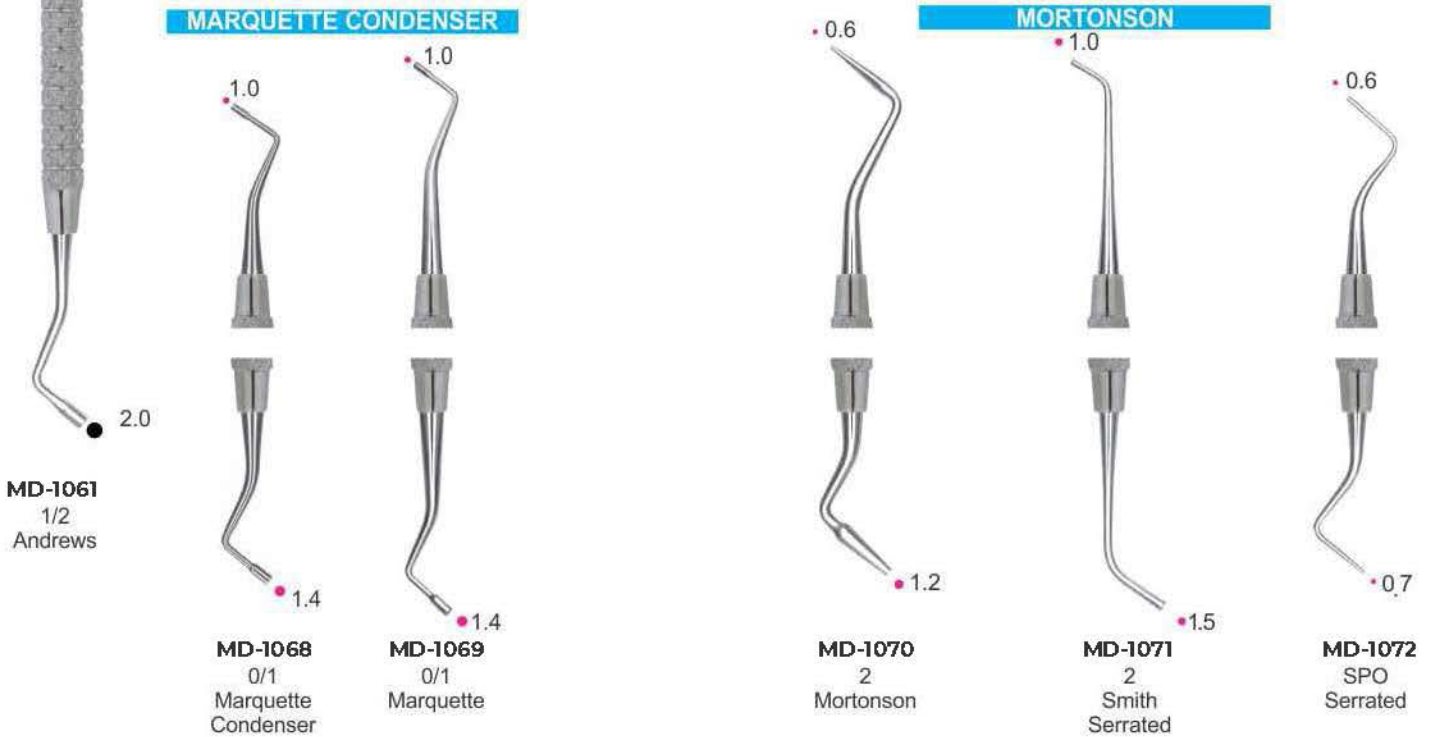

- Инструменты для реставрации
- Instruments pour plombage
- Füllungsinstrumente (mit Kontrawinkel)
- Инструменти для реставрації
- Instrumentos para obturaciones
- ملء الصكوك

RESTORATIVE INSTRUMENTS SOLID HANDLE 6MM, LENGTH 170MM
Back Action Filling Instruments

Tanner Filling Instruments



MD-1073
1T
Tanner



MD-1074
2T
Tanner

MD-1075
3T
Tanner



MD-1076
9/10
Back Action

MD-1077
11/12
Back Action



MD-1078
153
English Pattern
Serrated

MD-1079
153
English Pattern
Serrated

BALL



MD-1080
18

MD-1081
26/27S

BURNISHERS



MD-1082
27/29

DE-1083
2

BEAVERTAIL



MD-1083
2
Double-End

ACORN



MD-1084
21

MD-1085
21B

LADMORE



MD-1086
2
Ladmore

CARVERS INSTRUMENTS

- Инструменты для реставрации
- Instruments a modeler
- Modellierinstrumente

- Инструменти для реставрації
- Instrumentos para modelar
- أدوات تقطیع

P.K. THOMS WAXING INSTRUMENTS SOLID HANDLE 6mm

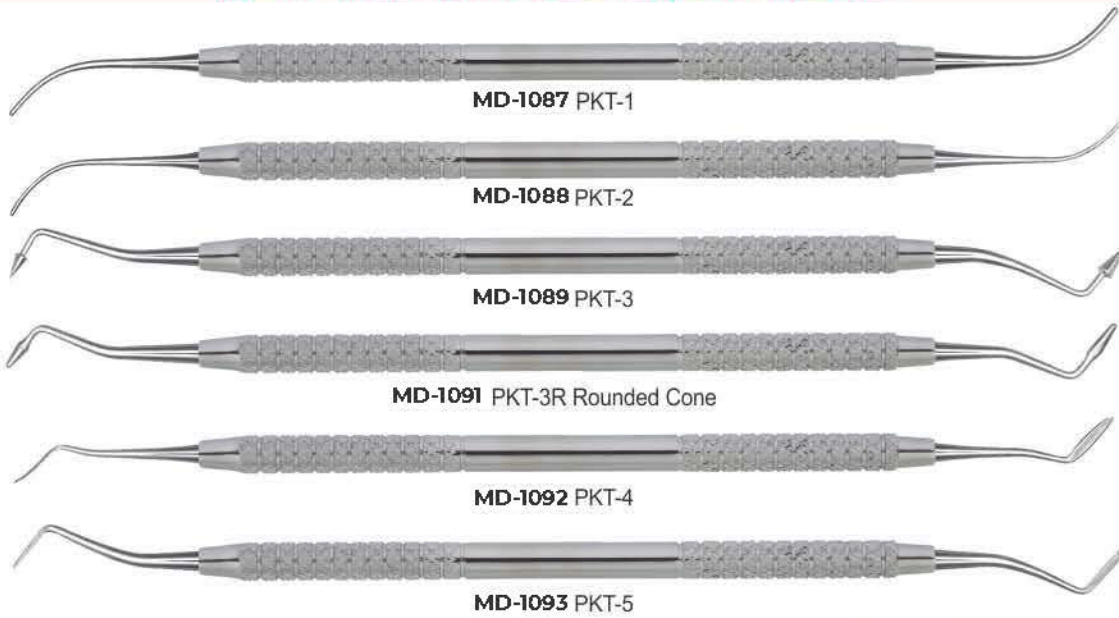

DE-1095
Composite Instruments Blue
Titanium with Cassettes



MD-1094
P.k. Thomas Waxing Instruments Kit

COMPOSITE INSTRUMENTS TITANIUM BLUE ENDODONTIC

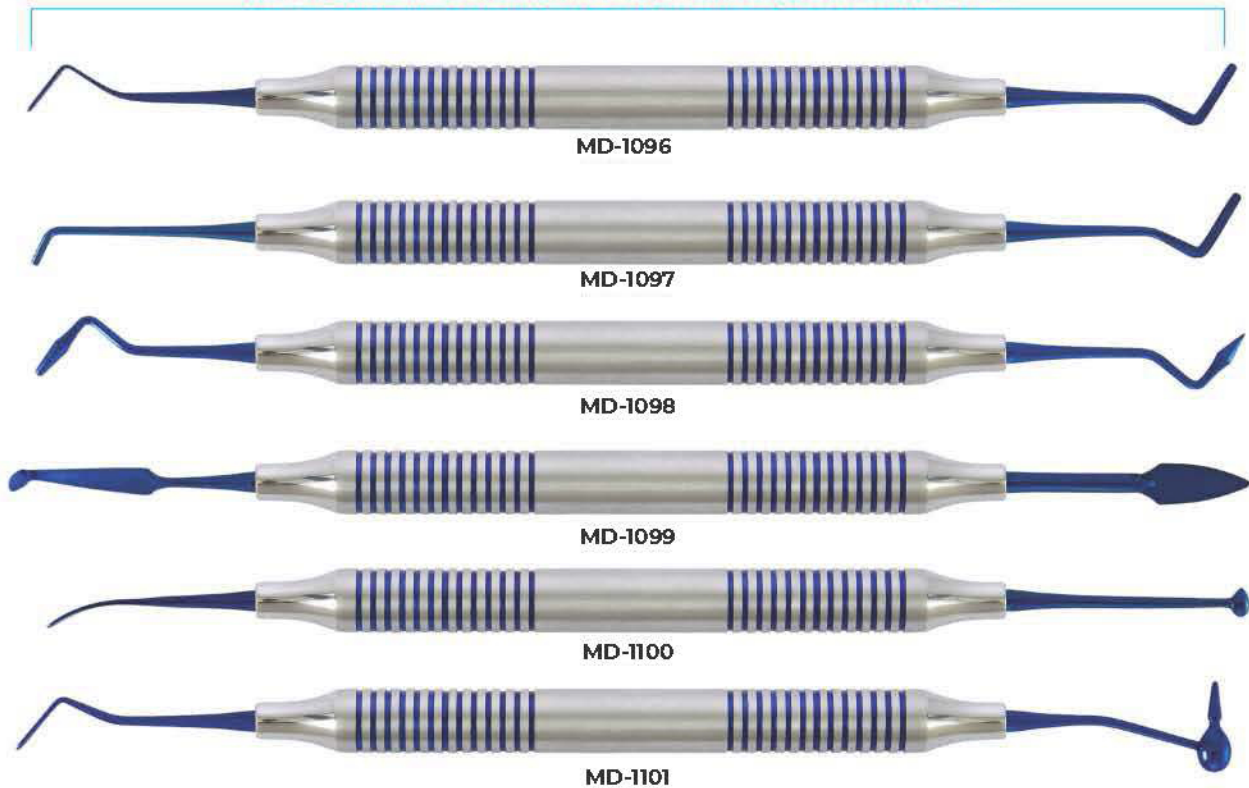

CARVERS INSTRUMENTS

- Инструменты для реставрации
- Instruments a modeler
- Modellierinstrumente
- Инструменти для реставрації
- Instrumentos para modelar
- أدوات تقطيع



MD-1102



MD-1103



MD-1104



MD-1105



MD-1106



Cassette For 5 Instruments
MD-1107

FILLING INSTRUMENTS

- Инструменты для реставрации
- Instruments pour plombage
- Füllungsinstrumente (mit Kontrawinkel)
- Инструменти для реставрації
- Instrumentos para obturaciones
- ملء الصكوك

FILLING INSTRUMENTS (Gold Pointed) SOLID HANDLE 6MM, LENGTH 170MM

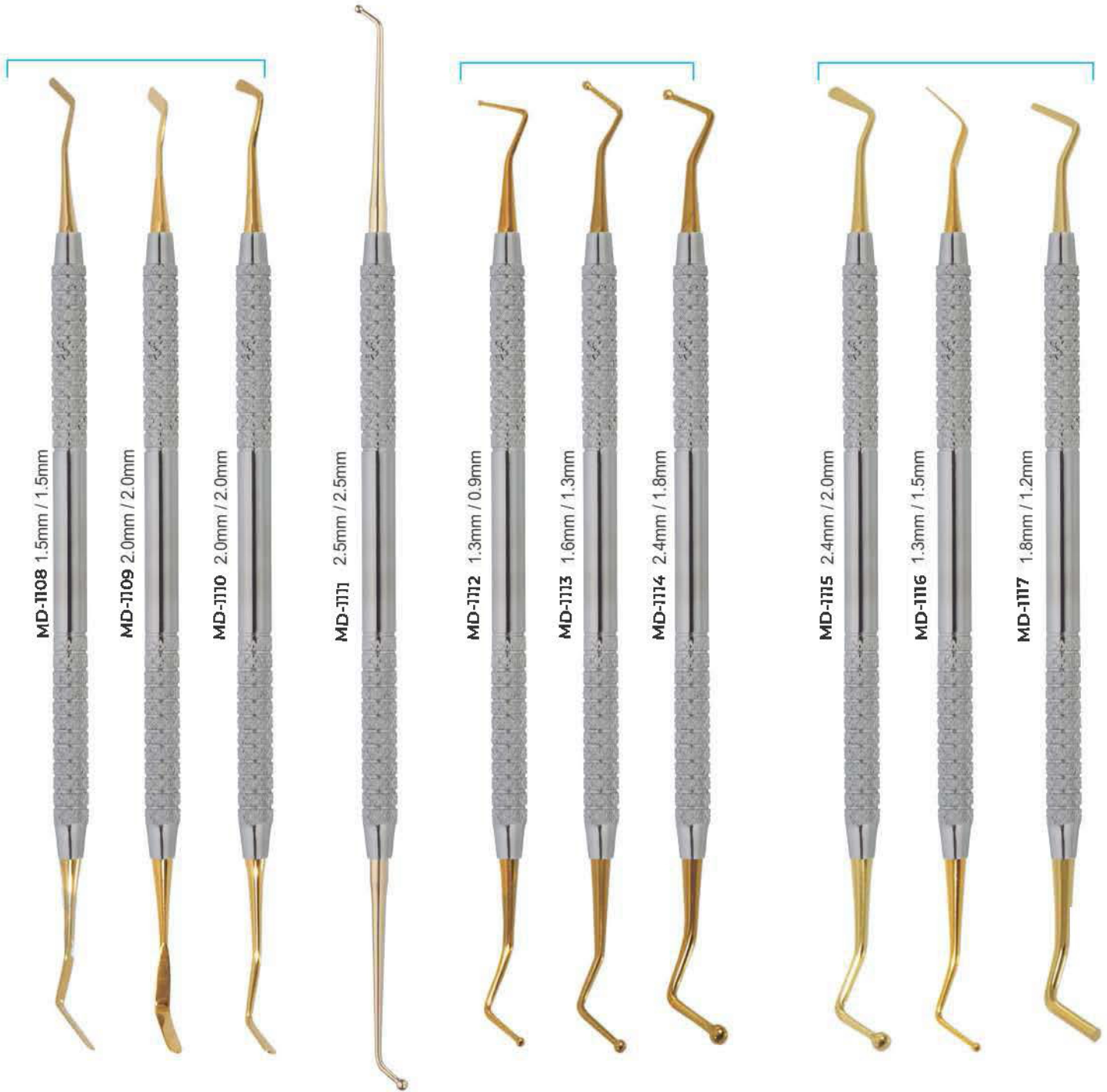

MD-1108 1.5mm / 1.5mm

MD-1109 2.0mm / 2.0mm

MD-1110 2.0mm / 2.0mm

MD-1111 2.5mm / 2.5mm

MD-1112 1.3mm / 0.9mm

MD-1113 1.6mm / 1.3mm

MD-1114 2.4mm / 1.8mm

MD-1115 2.4mm / 2.0mm

MD-1116 1.3mm / 1.5mm

MD-1117 1.8mm / 1.2mm

Filling instrument,
spatula 6 mm solid handle,
length 170 mm,

Filling instrument
6 mm
length 175 mm,

Filling instrument,
ball 6 mm
length 170 mm,

Filling instrument,
ball / spatula
6 mm
length 175 mm,

Filling instrument,
plan / plan 6 mm
length 165 mm,

- Инструменты для реставрации
- Instruments pour plombage
- Füllungsinstrumente (mit Kontrawinkel)
- Інструменти для реставрації
- Instrumentos para obturaciones
- ملء الصكوك

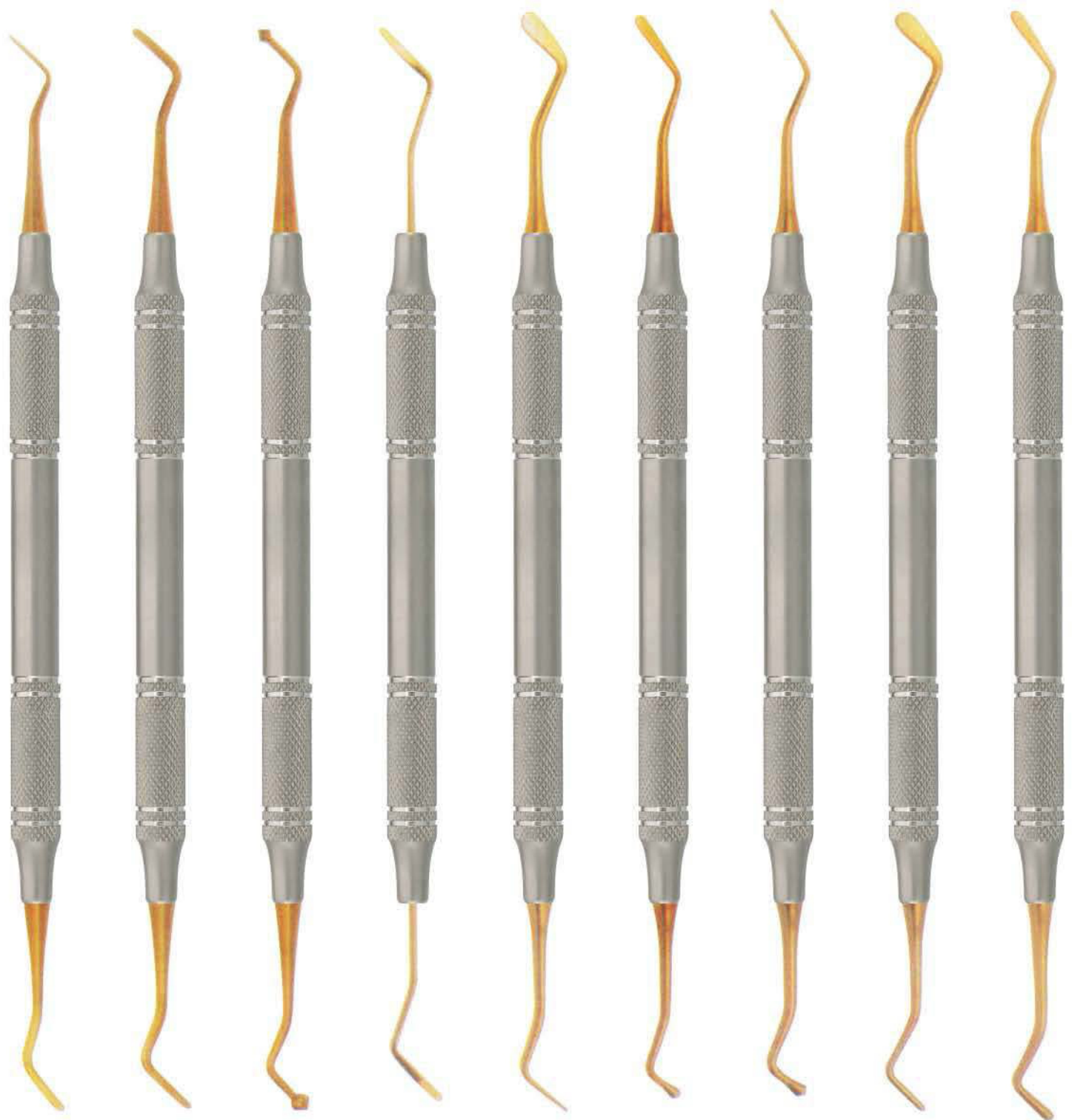

MD-1118

MD-1119

MD-1120

MD-1121

MD-1122

MD-1123

MD-1124

MD-1125

MD-1126

- Инструменты для реставрации
- Instruments pour plombage
- Füllungsinstrumente (mit Kontrawinkel)

- Инструменти для реставрації
- Instrumentos para obturaciones
- ملء الصكوك

Composite Gold Tip Instruments



- Прочие товары
- Divers produits et services
- Sonstige Produkte
- Інші товари
- Varios Productos
- المنتجات المتنوعة



MD-1138
X Ray Film Hangers



MD-1139
X Ray Film Hangers



MD-1140
X Ray Film Hangers



MD-1141
X Ray Film Hangers



MD-1142
X Ray Film Hangers



MD-1143
X Ray Film Hangers



MD-1144
X Ray Film Hangers



MD-1145



MD-1146



MD-1147



Dissecting Set
MD-1148 Set of 9 Pcs.
MD-1149 Set of 11 Pcs.



MD-1150
Napkin Holder with Plastic Chain

MD-1151
Napkin holder with metal chain



Mouth Props
MD-1152
Small

Mouth Props
MD-1153
Medium

Mouth Props
MD-1154
Large

Key Rings



MD-1155



MD-1156



MD-1157



MD-1158



MD-1159



MD-1160

CEMENT SPATULAS

- Шпатели для цемента
- Spatules à ciment
- Zementspatel
- Шпатели для цементу
- Espátulas para cemento
- ملاعق الاسمنت

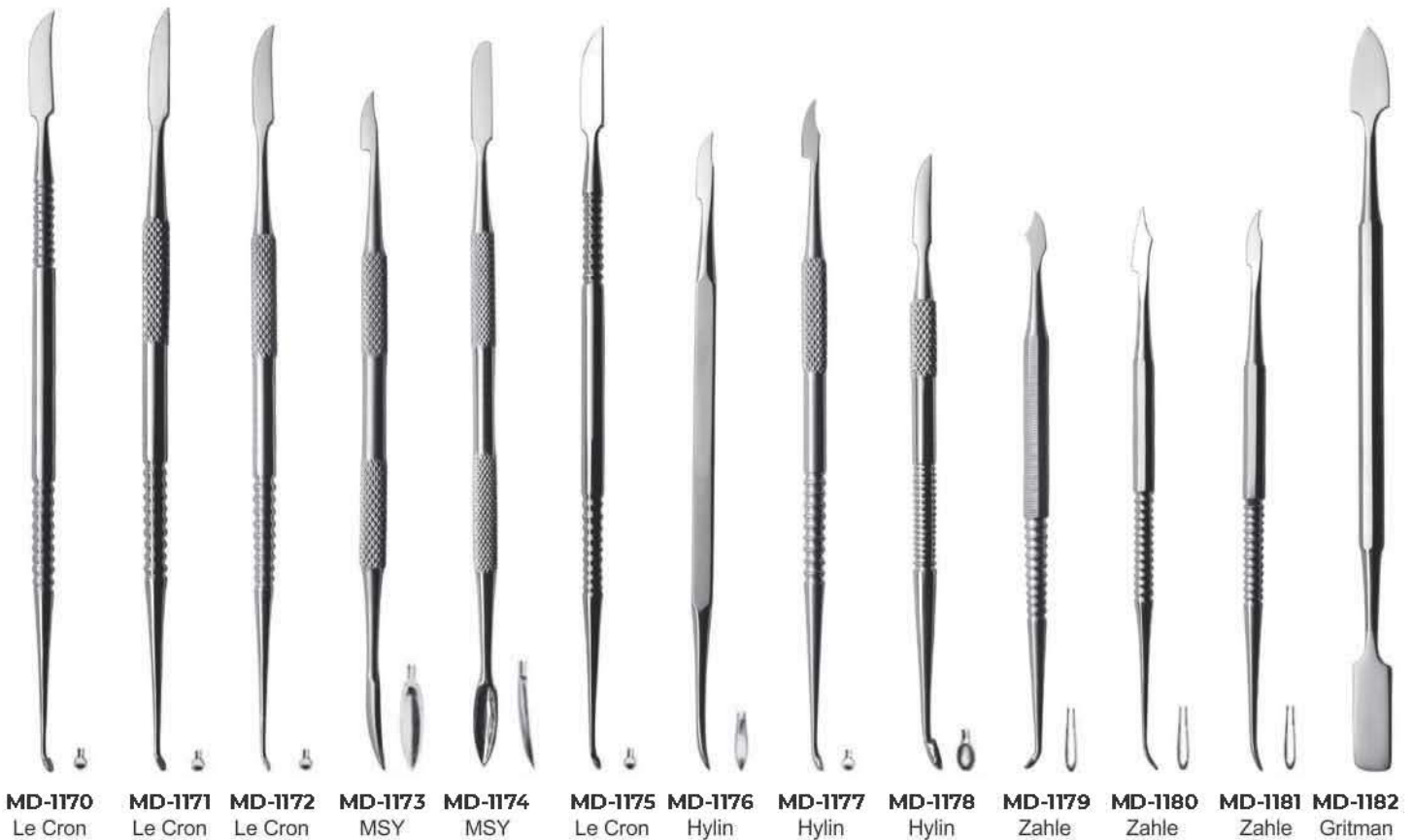
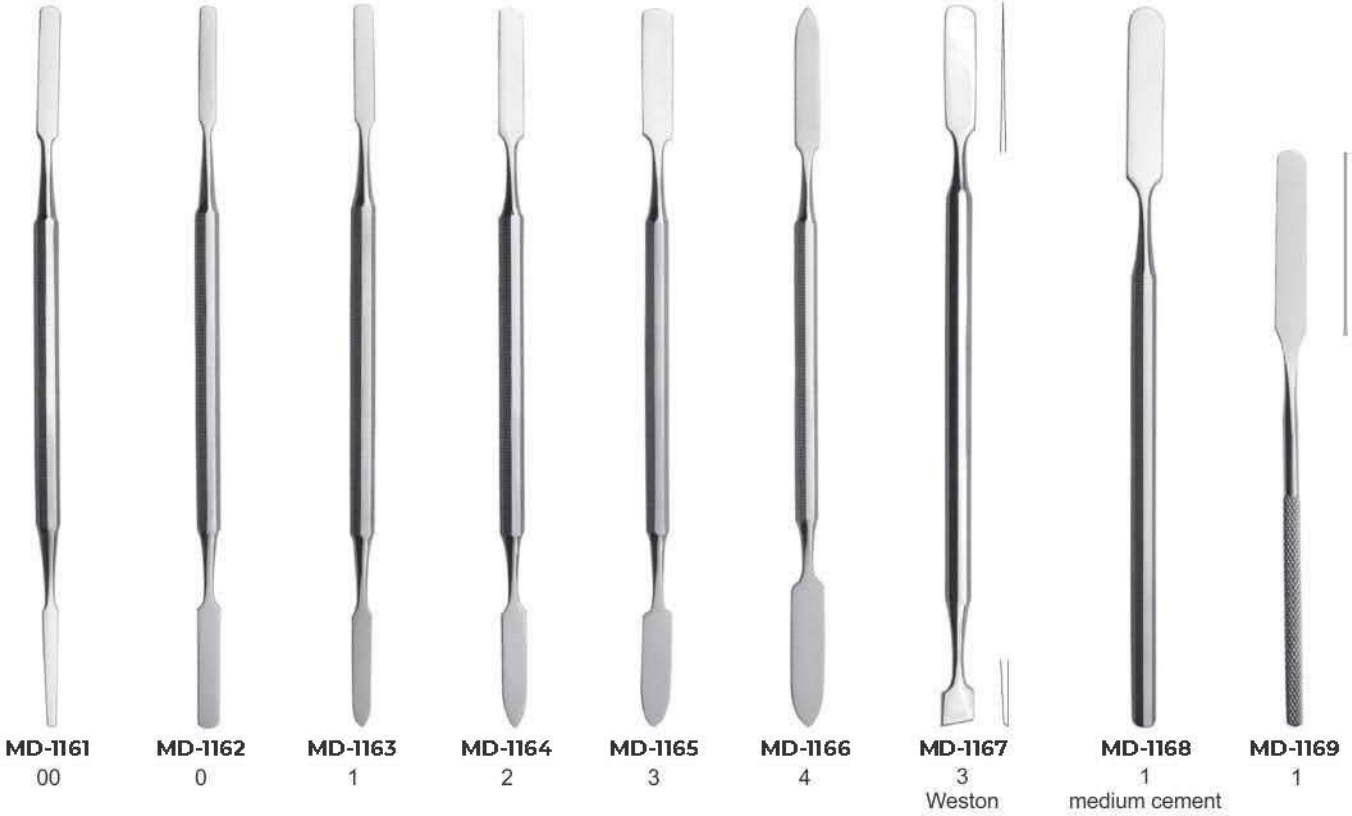

WAX KNIVES

- Ножи для воска
- Couteaux a cire
- Wachsmesser
- Ножи для воску
- Cuchillos para cera
- السكاكين الشمع

ALGINATE, PLASTER SPATULAS, WAX KNIVES PLASTER FOR KNIVES & PLASTER SHEAR



MD-1183
Wooden Handle
Fig. 5
21.5 cm



MD-1184
Wooden Handle
Fig. 7
19.5 cm curved



MD-1185
Wooden Handle
Fig. 8
20 cm curved



MD-1186
Wooden Handle
Fig. 9
22.5 cm curved



MD-1187
Hook Knives



MD-1188
Fig. 1
Lessmann
12.5 cm



MD-1189
Fig. 2
Lessmann
17 cm



MD-1190
Fig. 1
with small spoon
12.5 cm



MD-1191
Fig. 2
with large spoon
17 cm



MD-1192
Bacolite Handle
Wax Knives,
Small



MD-1193
Bacolite Handle
Wax Knives,
Large



MD-1194
Wooden Handle
Wax Knives,
Small



MD-1195
Wooden Handle
Wax Knives,
Large



MD-1196
Plaster Knife



MD-1197
Fig. 1
17 cm



MD-1198
Fig. 3
16 cm



MD-1199
Fig. 4
16 cm



MD-1200
Special Inox
19.5 cm

ARTICULATORS

- Артикуляторы
- Artocilar
- Artikulations

- Артикулятори
- Articuler
- آرتیکولاتورس



MD-1201

Technical Datas:

| | |
|----------------------------------|--------------|
| Intercondylar distance | 120 mm. |
| condylar inclination | fixed at 30° |
| Bennet angle | fixed at 7° |
| Incisal table inclination | 10° |
| Distance between mounting plates | 85 mm. |
| Weight | 400 gr. |
| Opening (item 5000) | 125° |
| Opening (item 5010) | 180° |



MD-1202

Technical Datas:

| | |
|----------------------------------|--------------|
| Intercondylar distance | 110 mm. |
| condylar inclination | fixed at 30° |
| Bennet angle | fixed at 7° |
| Incisal table inclination | flat |
| Distance between mounting plates | 85 mm. |
| Weight | 450 gr. |
| Opening | 180° |



MD-1203

Stainless Steel Finishing

MD-1204

Royal Blue



MD-1205



MD-1206



MD-1207



MD-1208



MD-1209



MD-1210



MD-1211



MD-1212



MD-1213



MD-1214
Nakawalni
Dental Laboratory
Instrument

