

Haemostatic Forceps (Micro Aproximators)

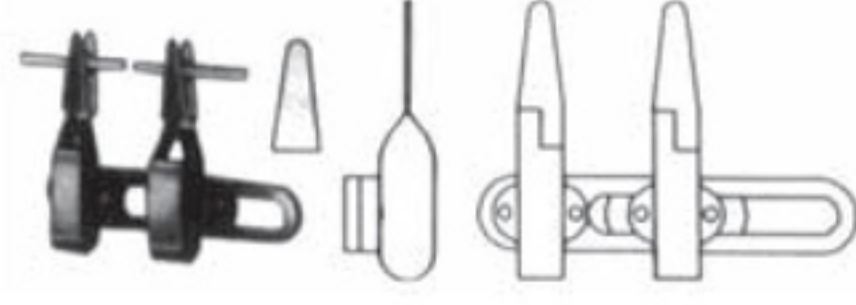

BIEMER-MULLER
GH1000.07
Çene uzunluğu/Lenght of jaws.6 mm
Açıklık/Opening 4 mm
Kapanma kuvveti/Closing force 30-40 gr.

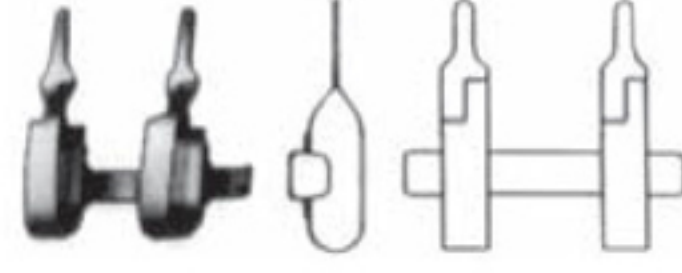

BIEMER-MULLER
GH1000.08
Çene uzunluğu/Lenght of jaws.4.5 mm
Açıklık/Opening 3 mm
Kapanma kuvveti/Closing force 25-30 gr.

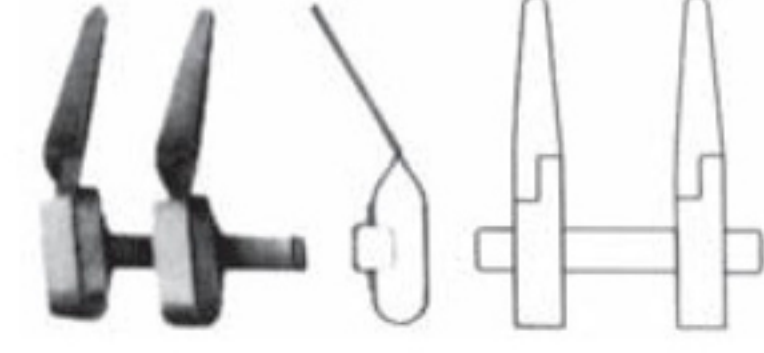

BIEMER-MULLER
GH1000.09
Çene uzunluğu/Lenght of jaws.9 mm
Açıklık/Opening 5 mm
Kapanma kuvveti/Closing force 25-30 gr.

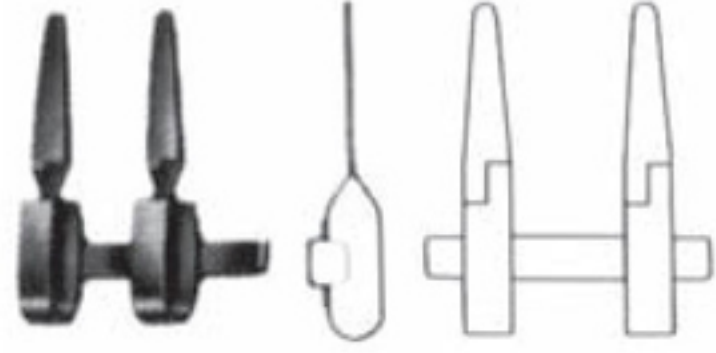

BIEMER-MULLER
GH1000.10
Çene uzunluğu/Lenght of jaws.9 mm
Açıklık/Opening 5 mm
Kapanma kuvveti/Closing force 25-30 gr.

Ø 1 mm

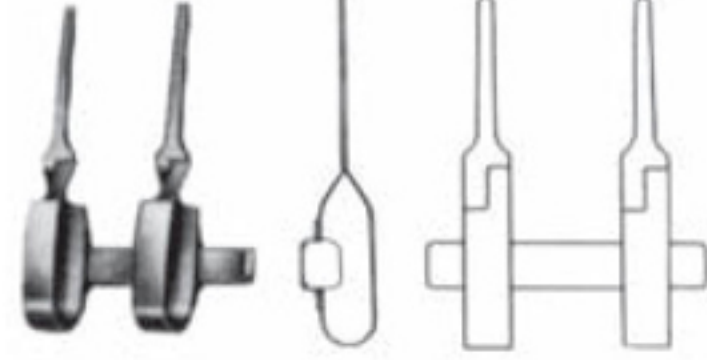

BIEMER-MULLER
GH1000.11
Çene uzunluğu/Lenght of jaws.9 mm
Açıklık/Opening 5 mm
Kapanma kuvveti/Closing force 25-30 gr.

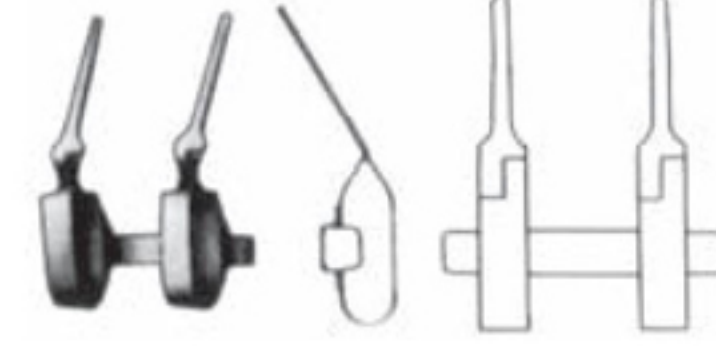

BIEMER-MULLER
GH1000.12
Çene uzunluğu/Lenght of jaws.9 mm
Açıklık/Opening 5 mm
Kapanma kuvveti/Closing force 25-30 gr.

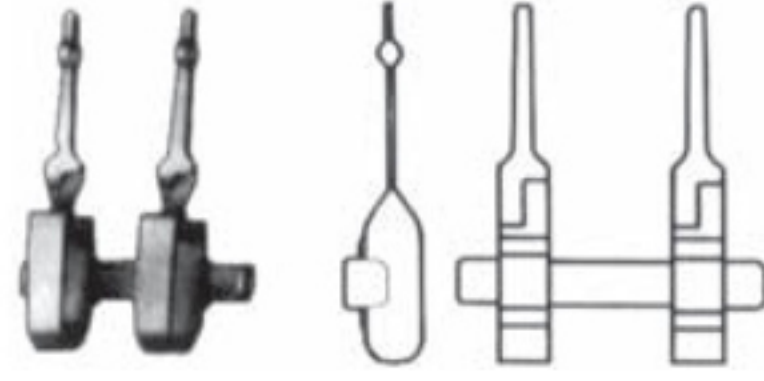

MULLER
GH1000.13
Kapanma kuvveti/Closing force. 25-30 gr.

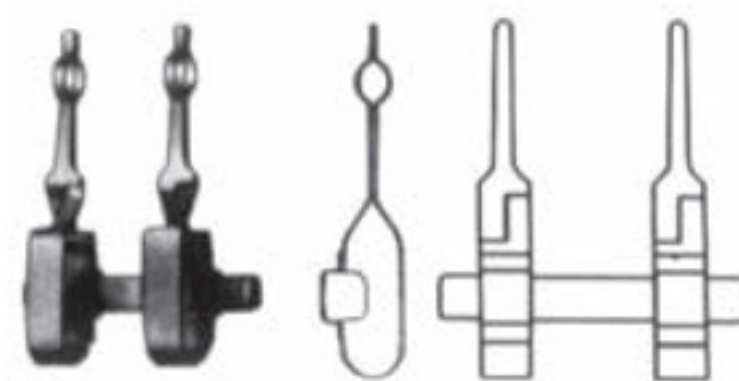

MULLER
GH1000.14
Kapanma kuvveti/Closing force. 25-30 gr.

Ø 2 mm

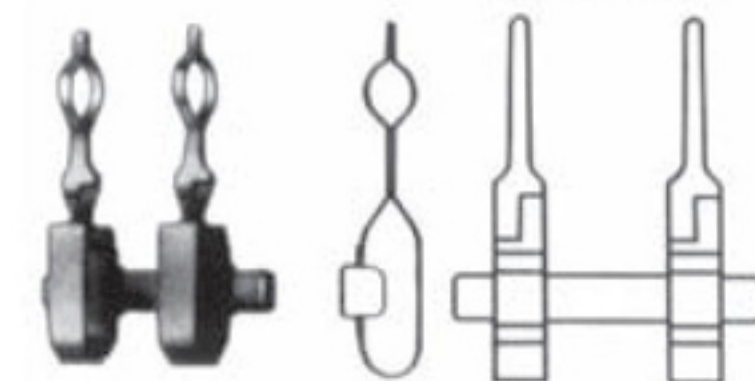

MULLER
GH1000.15
Kapanma kuvveti/Closing force. 25-30 gr.

Ø 3 mm



BIEMER
GH1000.17
Komple Aproximatör,
anahtarı ile S 029.00
Approximator, complete
with key S 029.00

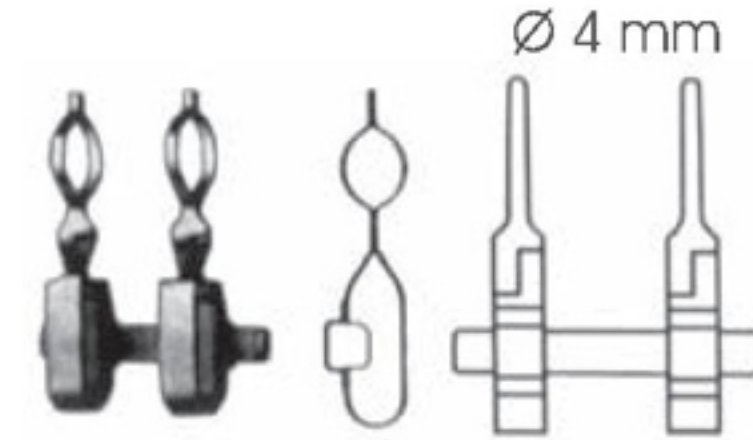

MULLER
GH1000.16
Kapanma kuvveti/Closing force. 25-30 gr.

Ø 4 mm



BIEMER
GH1000.18
Komple Aproximatör,
anahtarı ile S 029.00
Approximator, complete
with key S 029.00



GH1000.19
Approximator

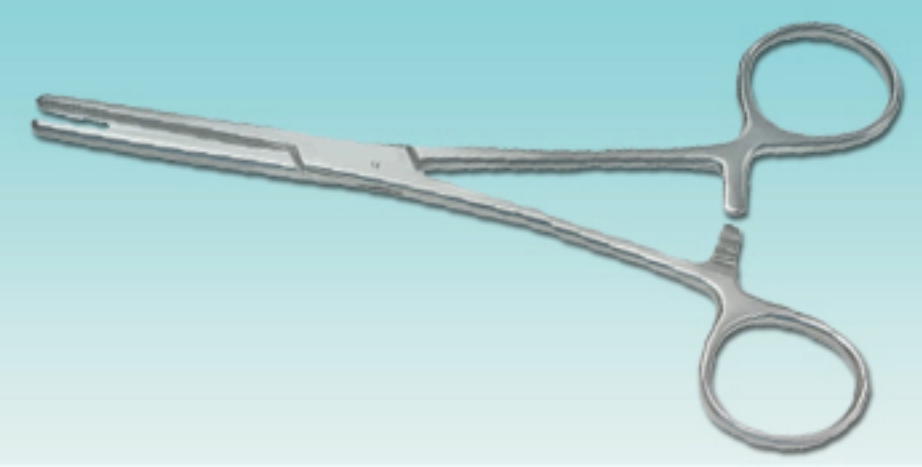

Haemostatic Forceps (Bulldog Clamps)

Mini/Mini
GH1000.23

Standart/Standard
GH1000.24

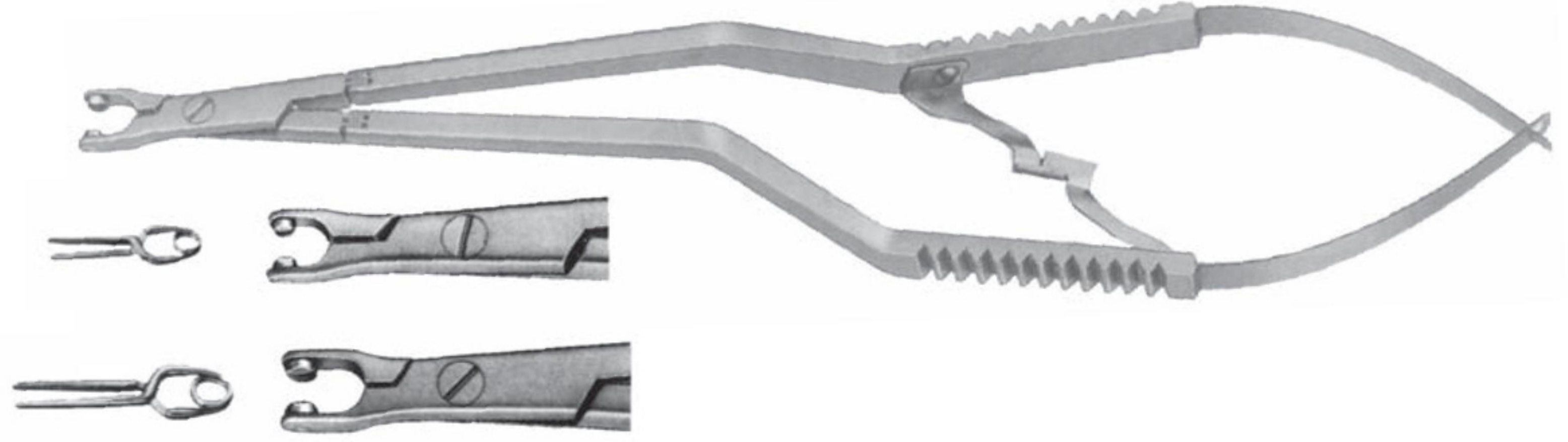

BIEMER
GH1000.22
Kilitsiz/Without Lock



BIEMER
GH1000.21
Kilitli/With Lock



BIEMER
GH1000.16
14.5 cm



MEHDORN
GH1000.20
Uygulama pensetleri, MEHDORN
damar klipleri
Applying forceps for MEHDORN
vessel clips
15 cm



Klipsler çeşitli pozisyonlarda uygun
Various positions of clips possible

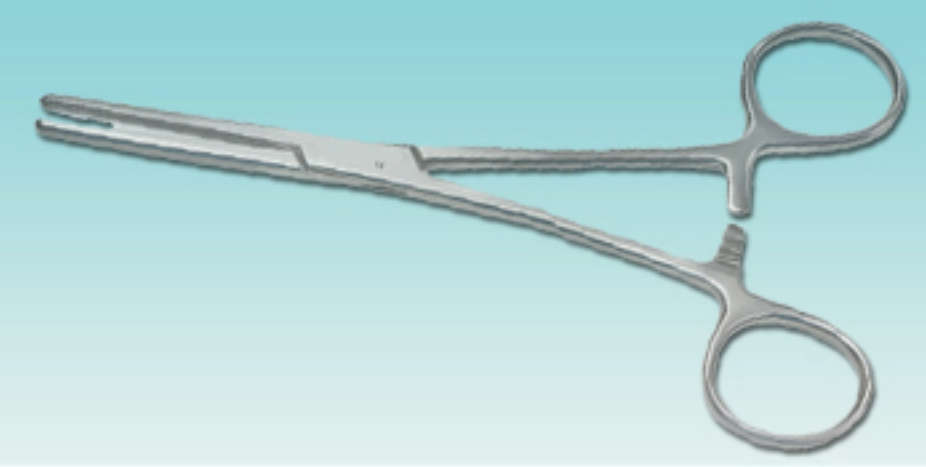

Haemostatic Forceps (Bulldog Clamps)



DIEFFENBACH



GH114.03
3.5 cm/1½"
11 mm



GH114.05
5 cm/2"
15 mm



GH115.03
3.5 cm/1½"
11 mm



GH115.05
5 cm/2"
15 mm



GH110.06
6 cm/2½"
17 mm



GH111.06
6 cm/2½"
17 mm



JOHNS-HOPKINS



GH115.38
3.8 cm/1½"
12 mm

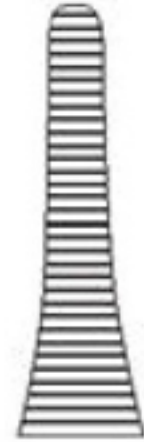

GH115.55
5.5 cm/2¼"
25 mm

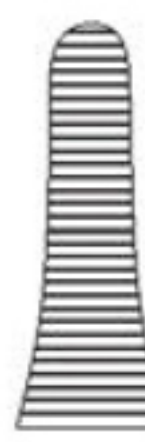

GH115.45
4.5 cm/1¾"
17 mm

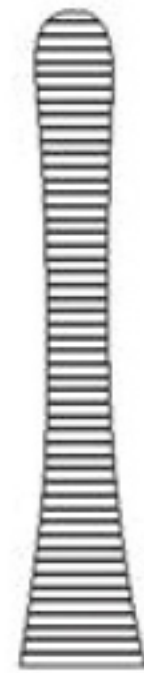

GH115.65
6.5 cm/2½"
30 mm



GH115.70
7 cm/2¾"
35 mm



GH115.75
7.5 cm/3"
40 mm



GH115.90
9 cm/3½"
50 mm



JOHNS-HOPKINS



GH116.38
3.8 cm/1½"
12 mm



GH116.45
4.5 cm/1¾"
17 mm



GH116.55
5.5 cm/2¼"
25 mm



GH116.65
6.5 cm/2½"
30 mm



GH116.70
7 cm/2¾"
35 mm









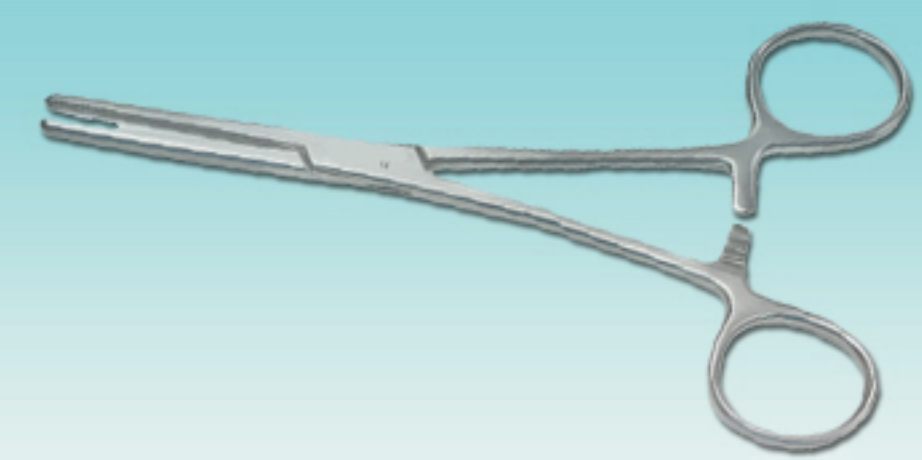





GH116.75
7.5 cm/3"
40 mm





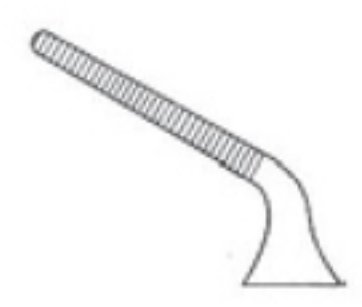
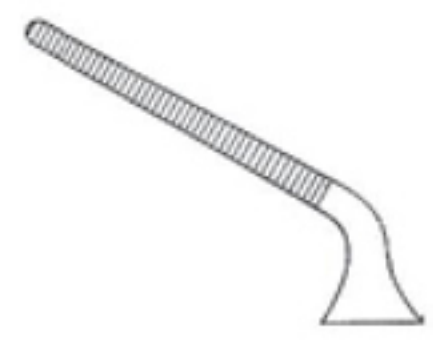



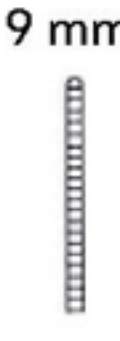

GH116.90
9 cm/3½"
50 mm







Haemostatic Forceps (Bulldog Clamps)

							
	GH120.08 4.5 cm/1¾" 8 mm	GH120.10 5 cm/2" 12 mm	GH120.12 6 cm/2¼" 20 mm	DEBAKEY	GH122.10 4.5 cm/1¾" 10 mm	GH122.14 5 cm/2" 14 mm	GH122.20 6 cm/2¼" 20 mm
							
DIETHRICH	GH121.08 4 cm/1½" 8 mm	GH121.10 4.5 cm/1¾" 12 mm	GH121.12 5 cm/2" 20 mm	DIETHRICH	GH123.10 4.5 cm/1¾" 10 mm	GH123.14 5 cm/2" 14 mm	GH123.20 6 cm/2¼" 20 mm

				
Mini-GLOVER	3 cm/1¼" GH132.30 GH142.30	3.5 cm/1½" GH132.35 GH142.35	4.0 cm/1½" GH132.40 GH142.40	5.0 cm/2" GH132.50 GH142.50

				
Mini-GLOVER	3 cm/1¼" GH133.30 GH143.30	3.5 cm/1½" GH133.35 GH143.35	4.0 cm/1½" GH133.40 GH143.40	5.0 cm/2" GH133.50 GH143.50

				
Mini-GLOVER	3 cm/1¼" GH135.30 GH145.30	3.5 cm/1½" GH135.35 GH145.35	4.0 cm/1½" GH135.40 GH145.40	5.0 cm/2" GH135.50 GH145.50

Applying forceps



Mini-GLOVER
GH131.24
24 cm/9½"

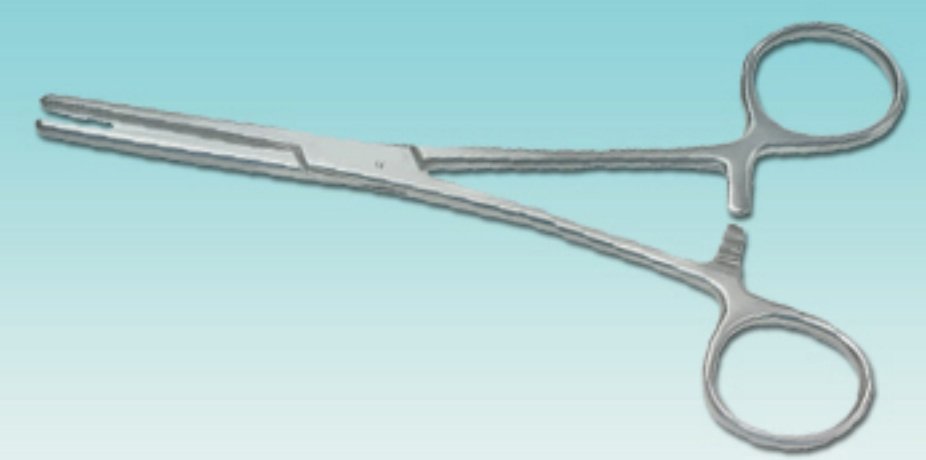

Haemostatic Forceps (Organ Grasping Forceps)

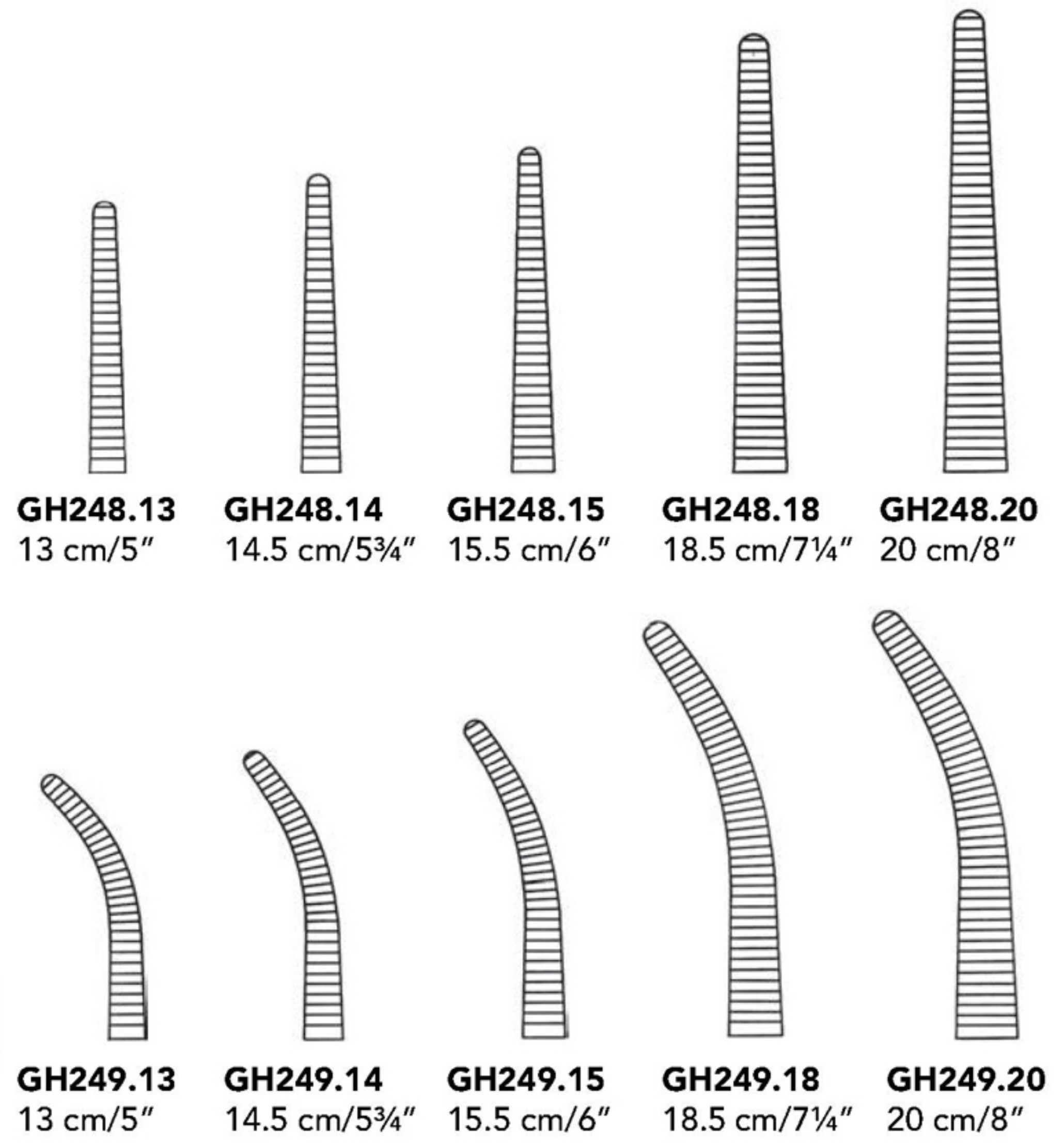

Organ grasping forceps

ATRAUMA

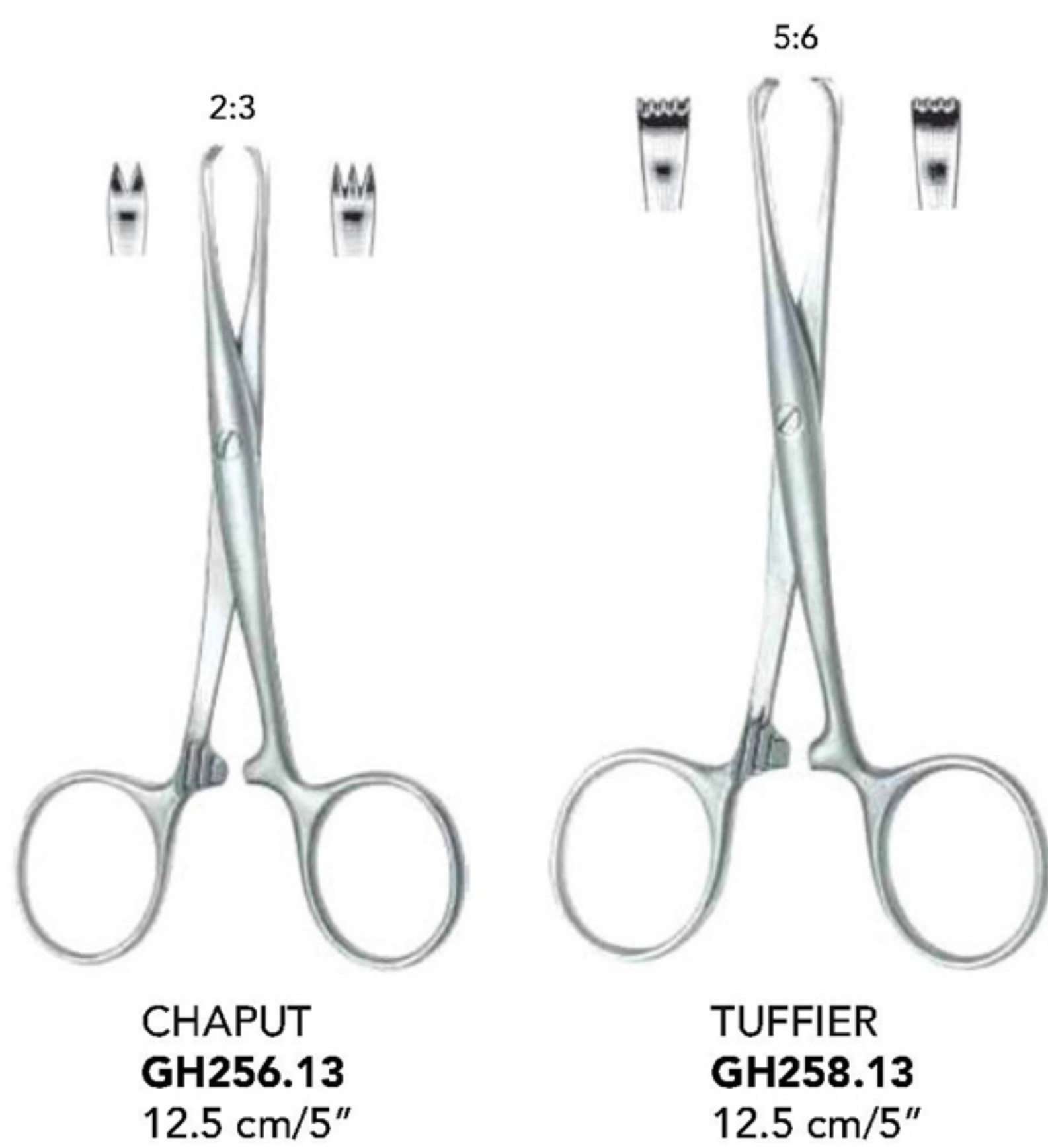

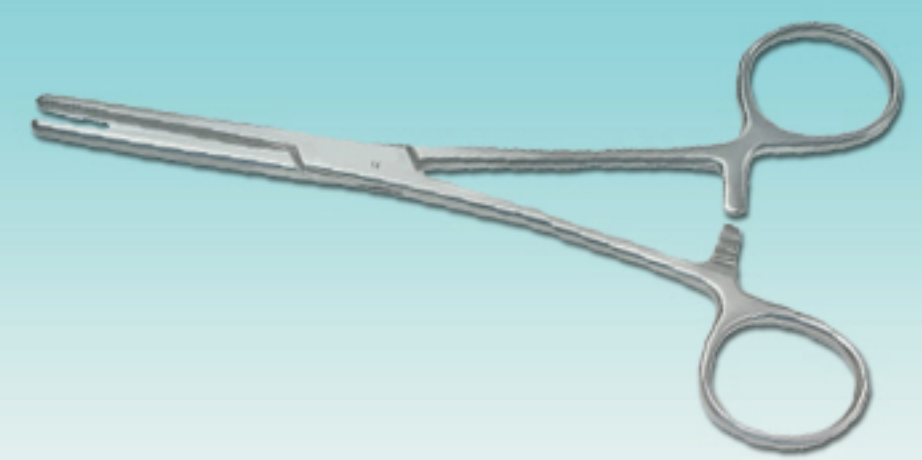

Haemostatic Forceps (Organ Grasping, Dissecting, Ligature Forceps)

Tumor grasping forceps

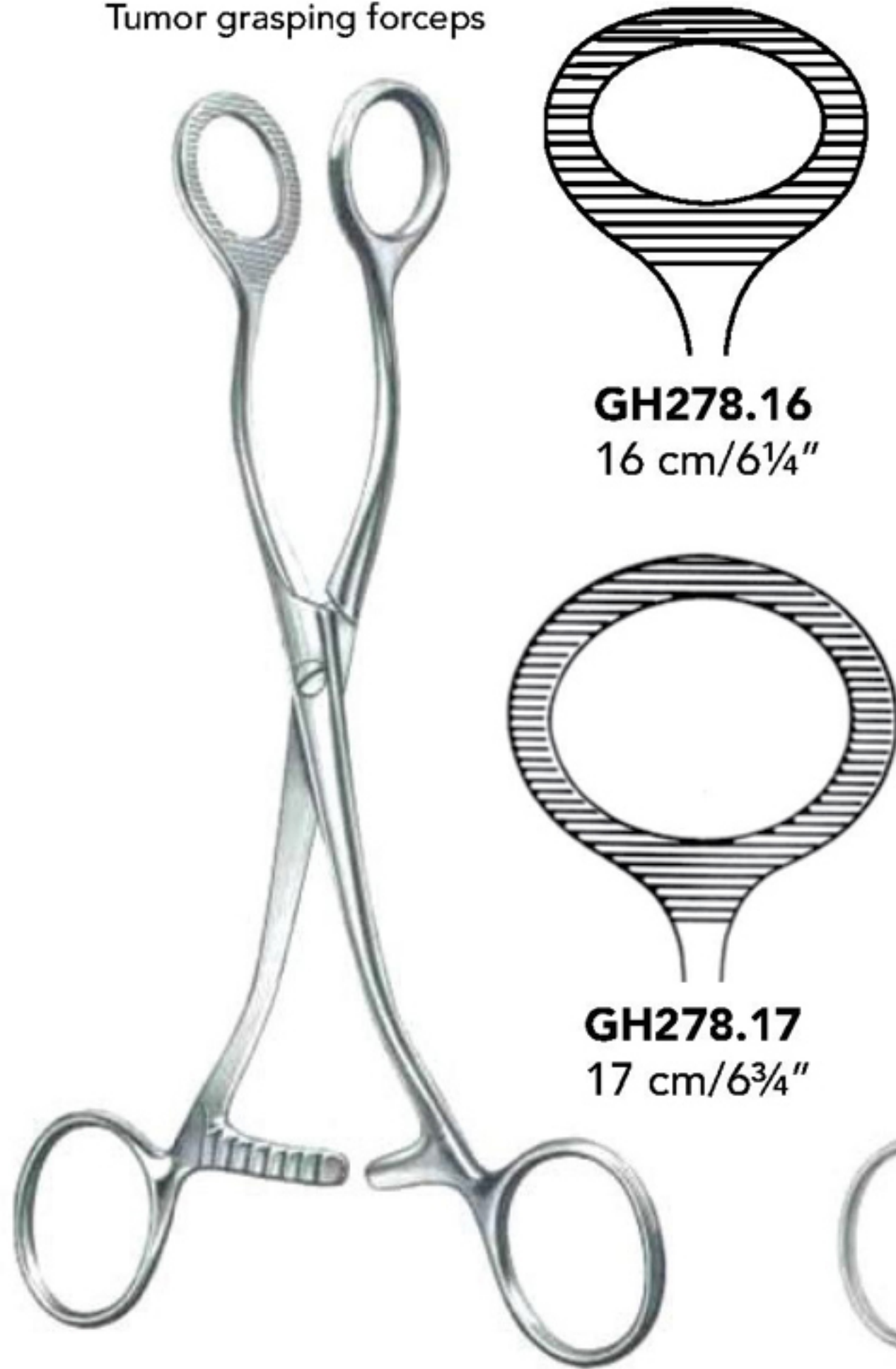

COLLIN

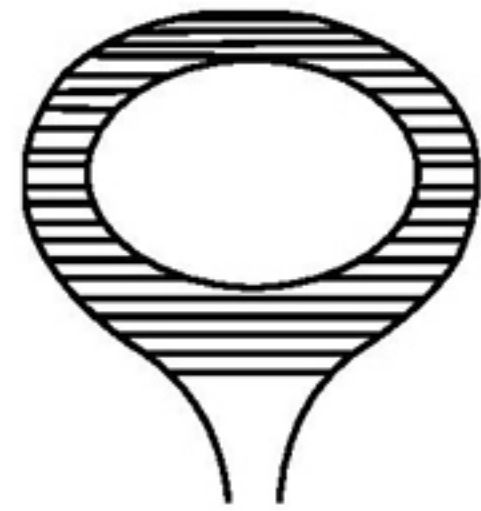

GH278.16
16 cm/6¼"



GH278.17
17 cm/6¾"

Organ grasping forceps

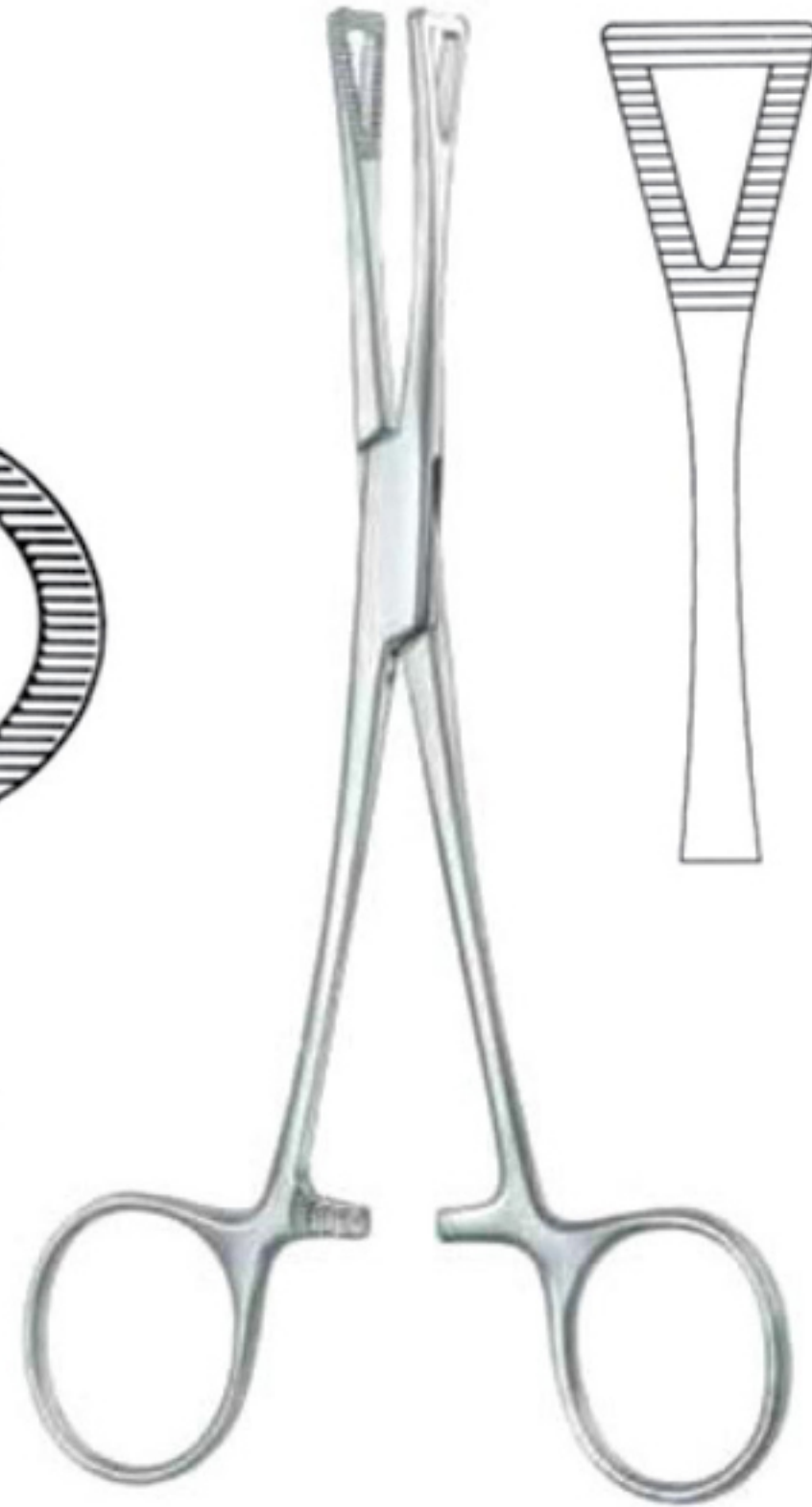

PENNINGTON
15.5 cm/6" **GH280.15**
21.0 cm/8¼" **GH280.20**



PRATT
GH282.15
15 cm/6"

Face-lift forceps



MARTEL-REES
GH290.14
13.5 cm/5¼"

Ligature forceps
smooth jaw



MARTEL
GH302.12
12.5 cm/5"



HARTMANN
10 cm/4"

Ligature forceps

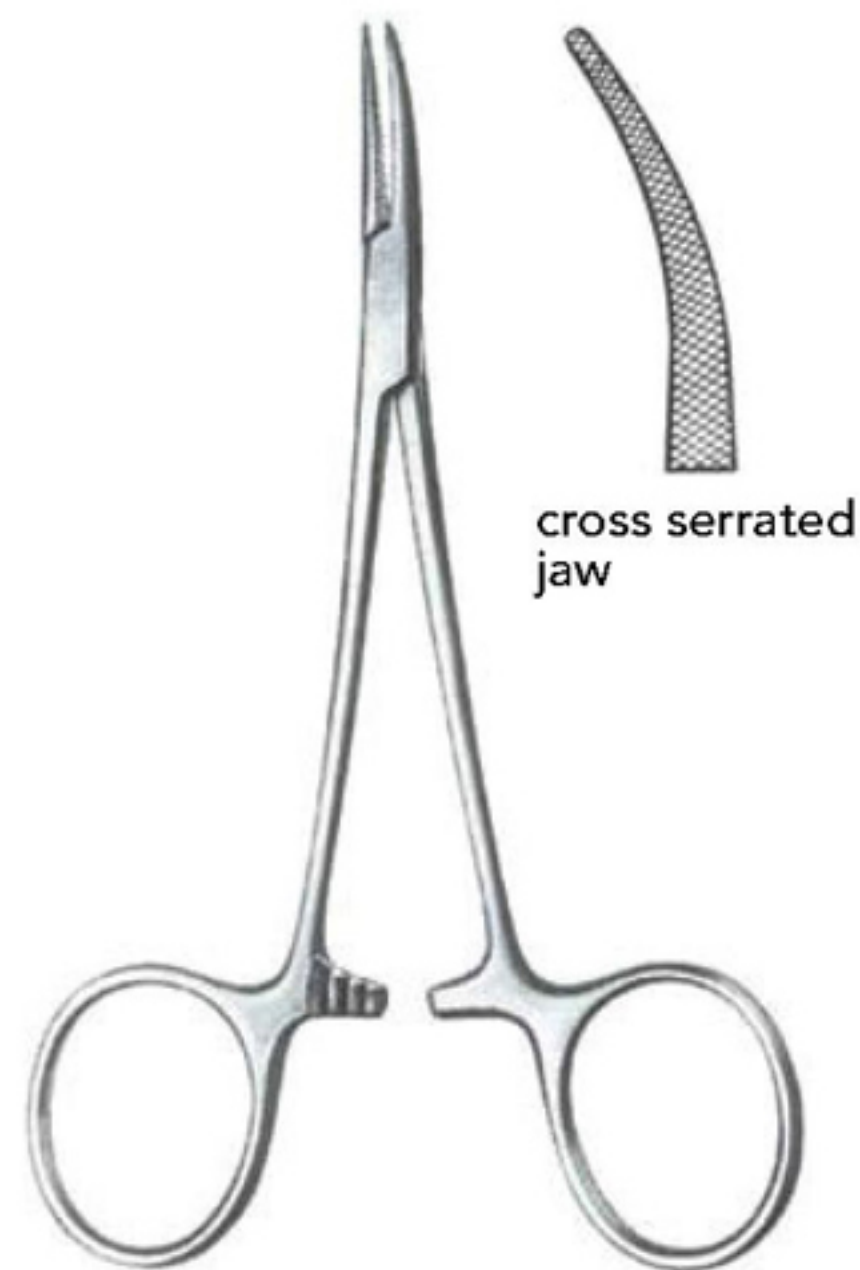

GH309.12
12 cm/4¾"



PROVIDENCE-HOSPITAL
14 cm/5½"

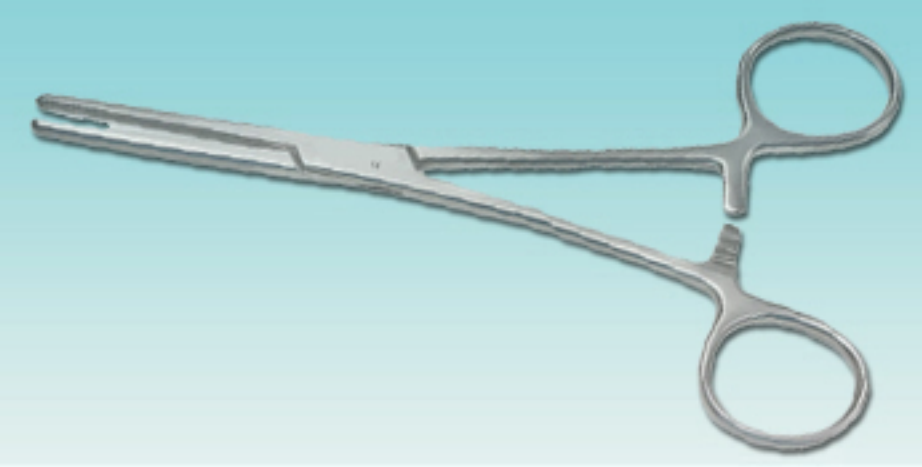

Haemostatic Forceps (Dissecting & Ligature Forceps)



HALSTED-MOSQUITO



GH310.12
12.5 cm/5"



GH311.12
12.5 cm/5"



GH310.14
14.5 cm/5¾"



GH311.14
14.5 cm/5¾"



GH312.12
12.5 cm/5"



GH313.12
12.5 cm/5"



GH312.14
14.5 cm/5¾"



GH313.14
14.5 cm/5¾"

1:2



HALSTED-MOSQUITO



GH316.18
18.5 cm/7¼"



GH317.18
18.5 cm/7¼"



GH316.21
21 cm/8¼"



GH317.21
21 cm/8¼"



GH318.18
18.5 cm/7¼"



GH319.18
18.5 cm/7¼"



GH318.21
21.0 cm/8¼"

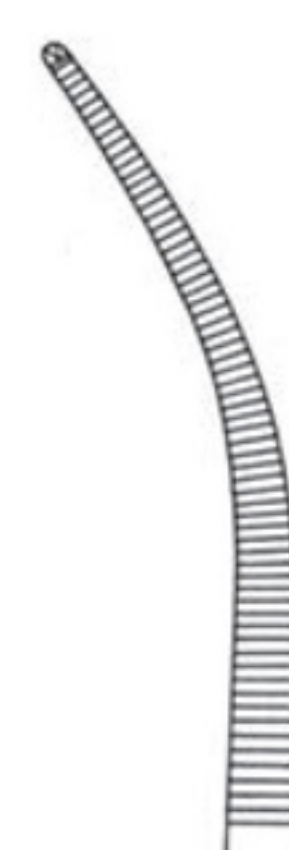

GH319.21
21.0 cm/8¼"



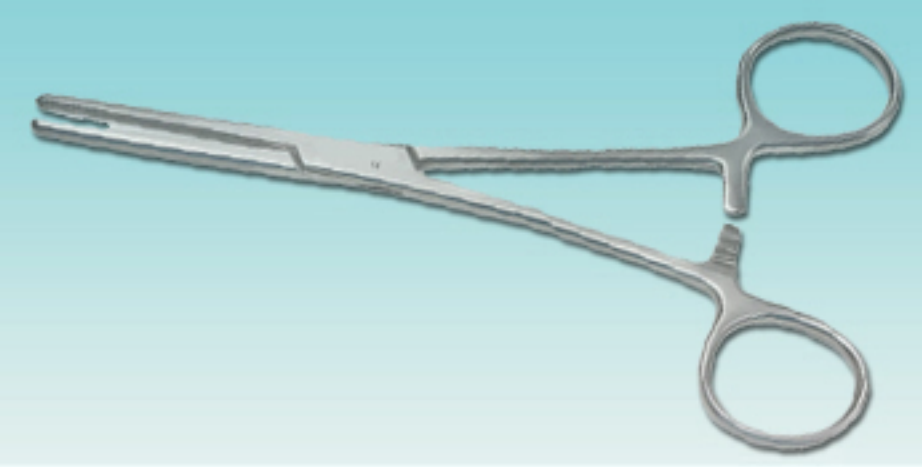





1:2



Haemostatic Forceps (Dissecting & Ligature Forceps)







MICRO-MOSQUITO

			
GH320.10 10 cm/4"	GH321.10 10 cm/4"	GH320.12 12 cm/4¾"	GH321.12 12 cm/4¾"
			
GH322.10 10 cm/4"	GH323.10 10 cm/4"	GH322.12 12 cm/4¾"	GH323.12 12 cm/4¾"

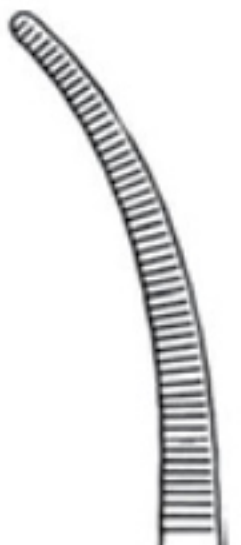

LERICHE
15.5 cm/6"

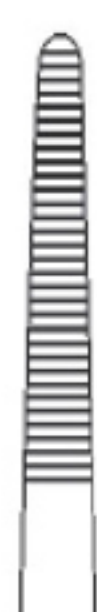
		
GH326.15	GH327.15	
		
GH328.15	GH329.15	DUNHILL GH332.12 12.5 cm/5"

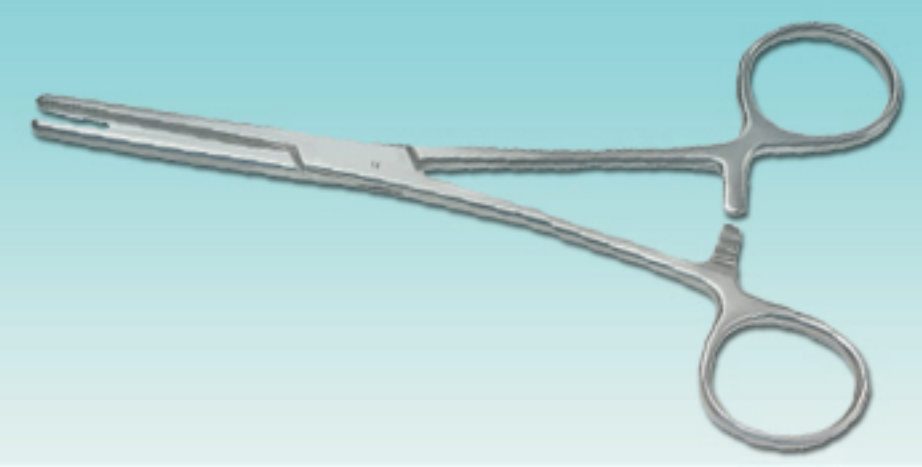

Haemostatic Forceps (Dissecting & Ligature Forceps)



DUNHILL
GH333.19
18.5 cm/7¼"



GH330.14

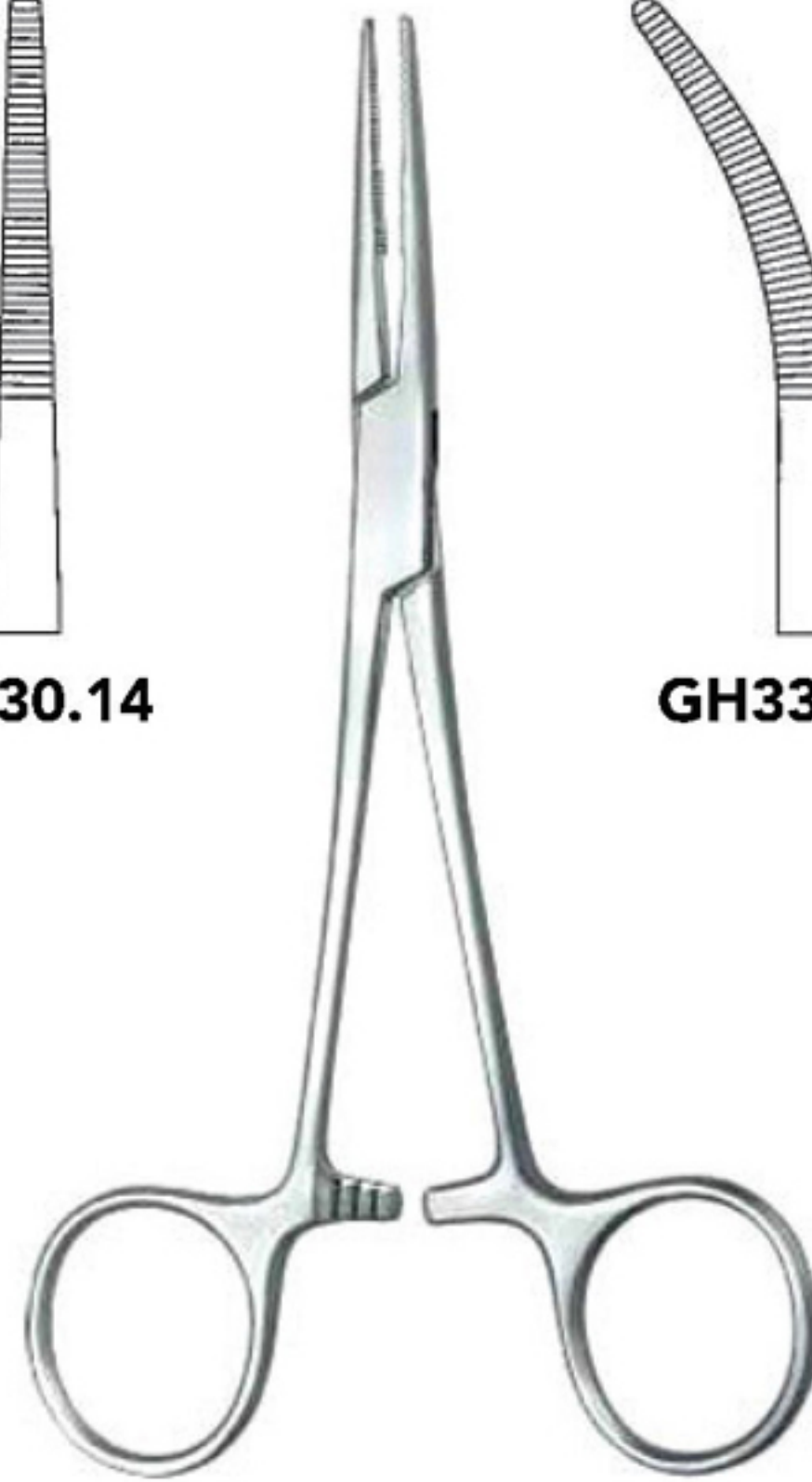

KELLY
14.5 cm/5¾"

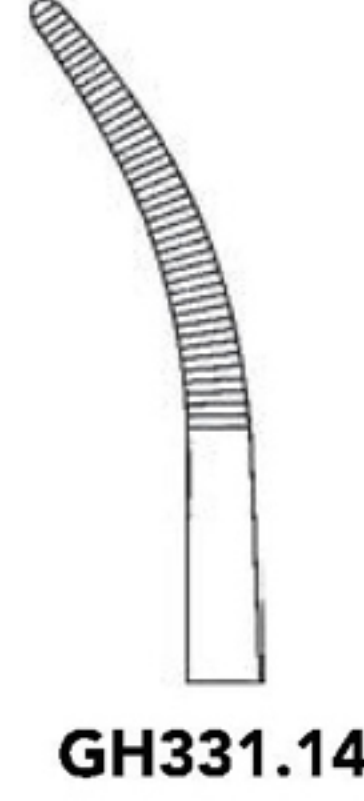

GH331.14

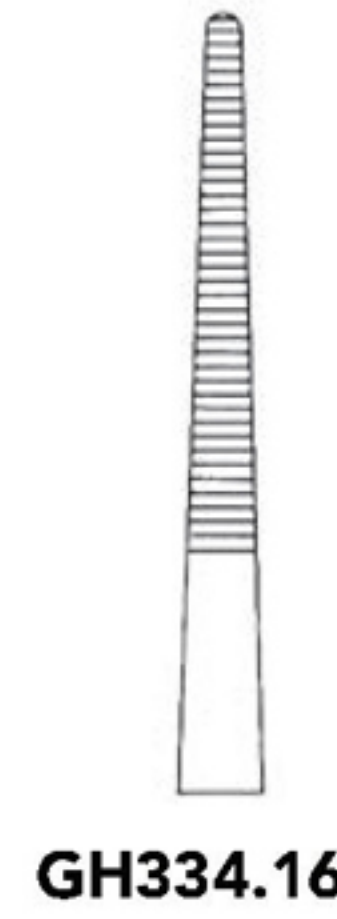

GH334.16

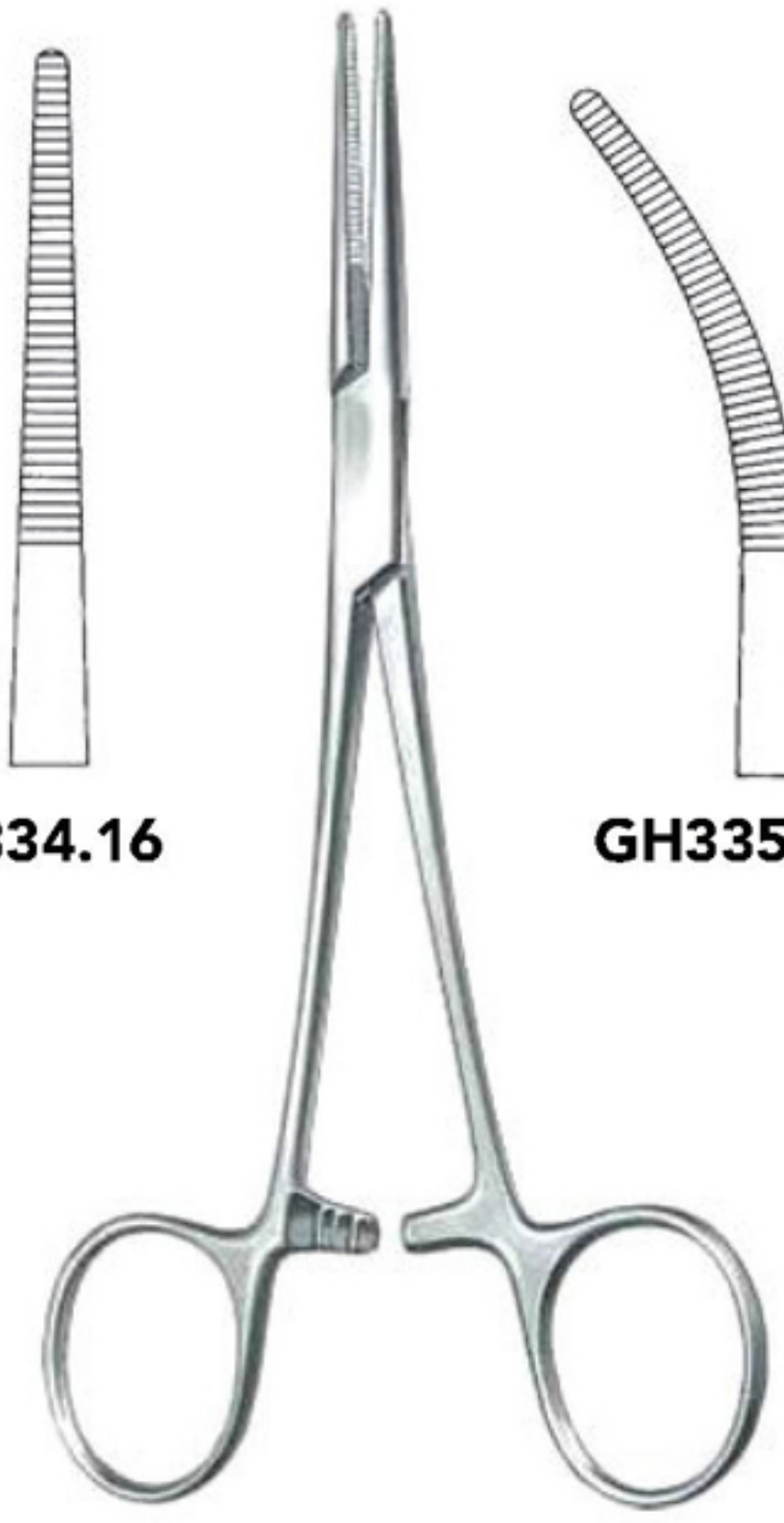

KELLY-RANKIN
16 cm/6¼"



GH335.16



GH340.14



GH341.14



GH346.16



GH347.16



GH348.15



GH350.15

Cross serrated jaw

1:2



CRILE
14.5 cm/5¾"



GH342.14

1:2



GH343.14

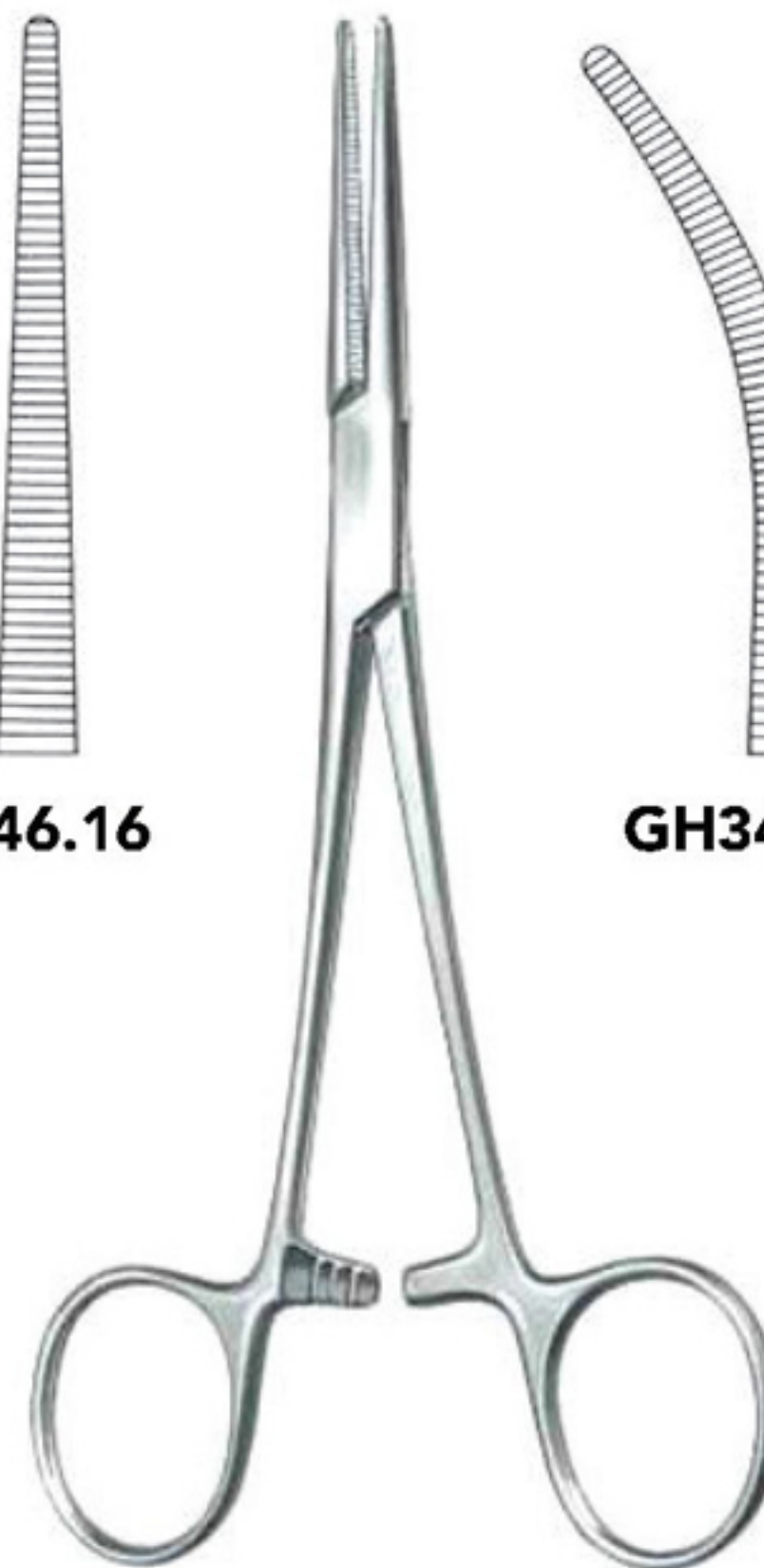

CRILE-RANKIN
16 cm/6¼"

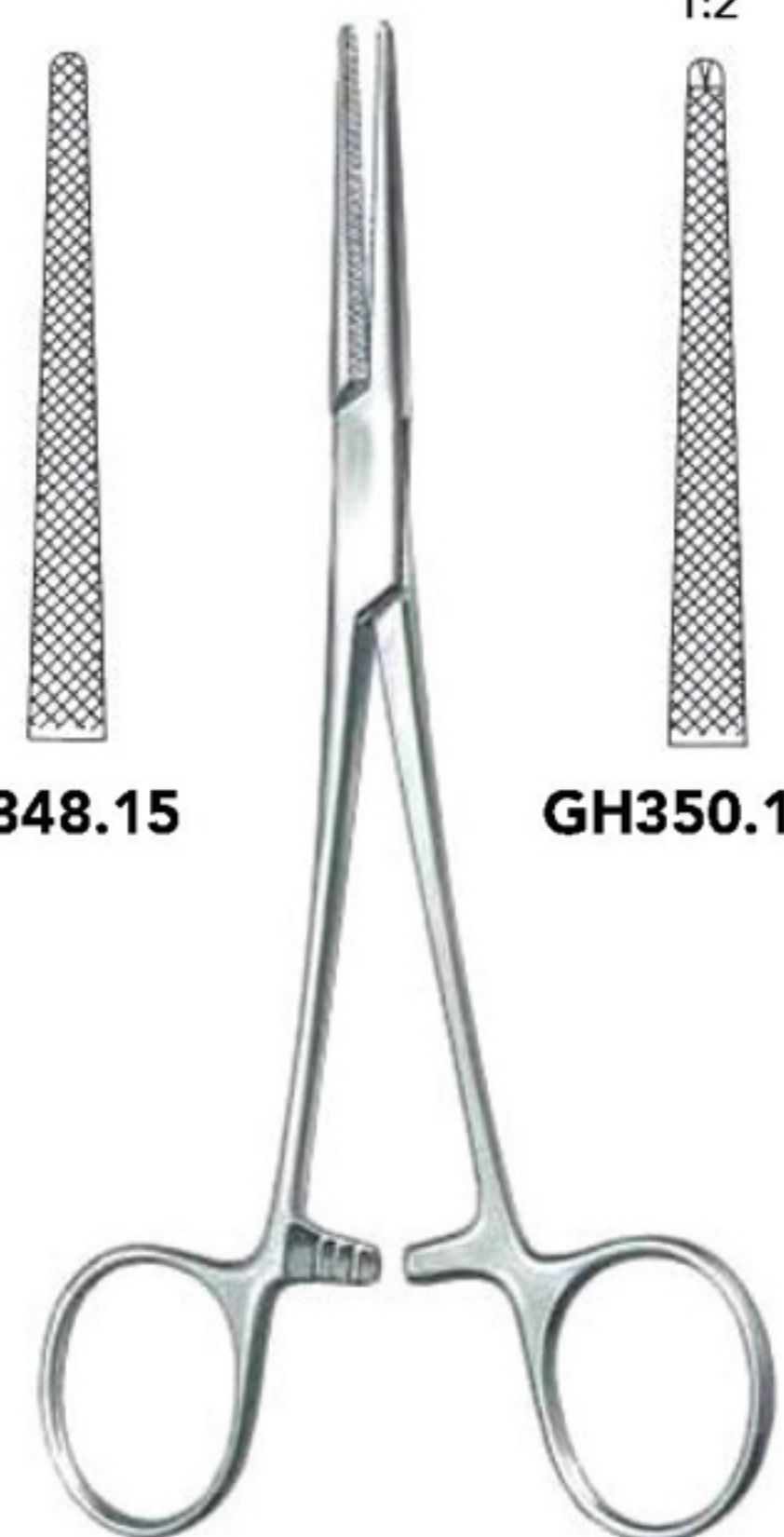

LOVELL
16 cm/6¼"

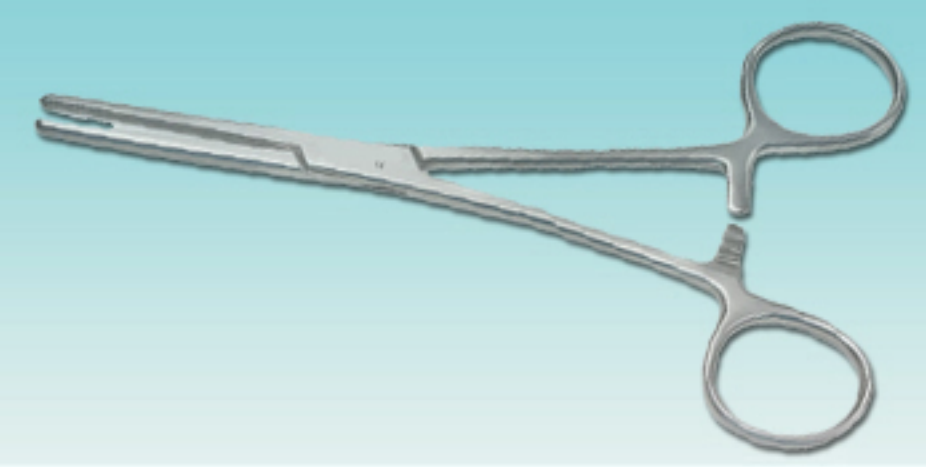

Haemostatic Forceps (Dissecting & Ligature Forceps)

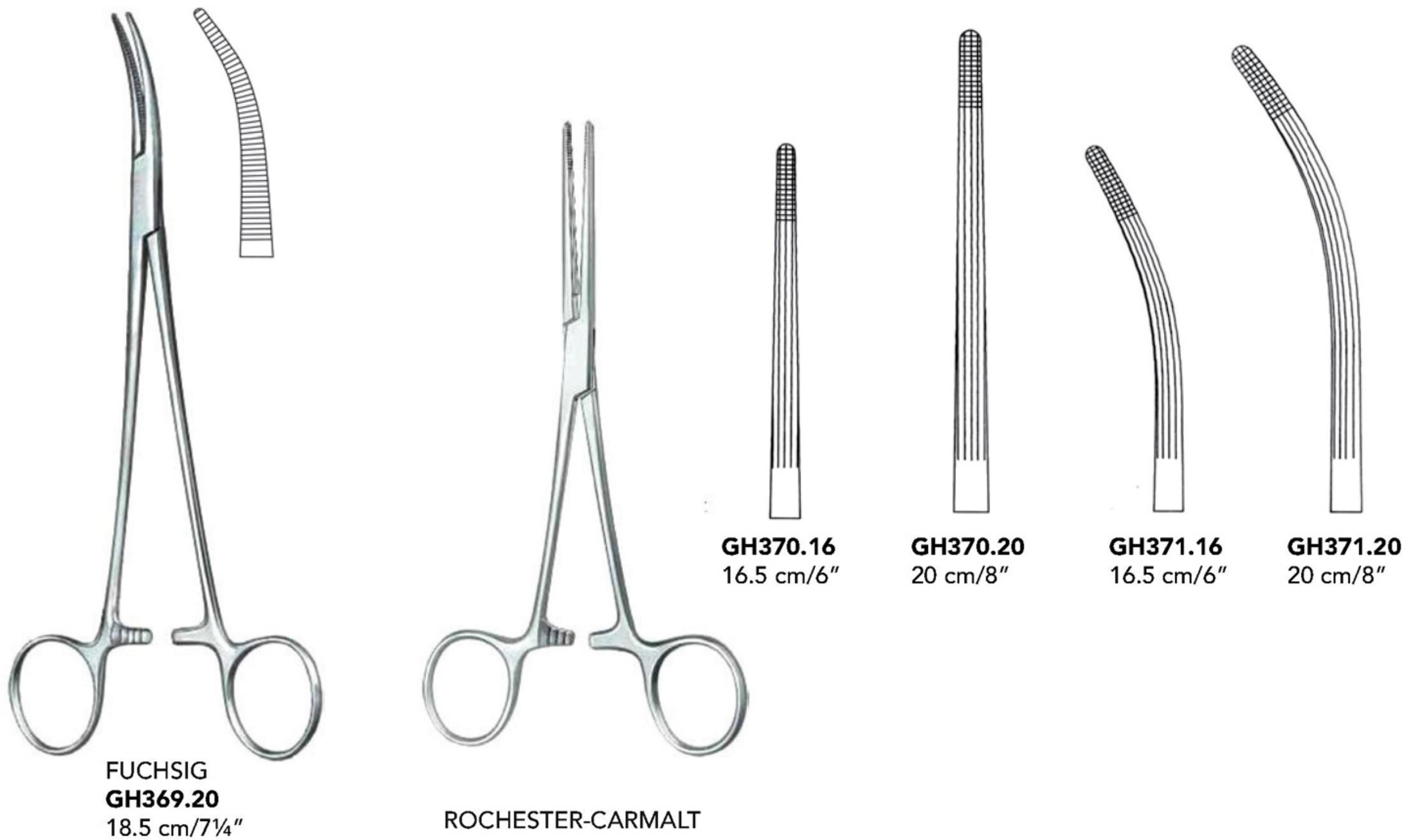
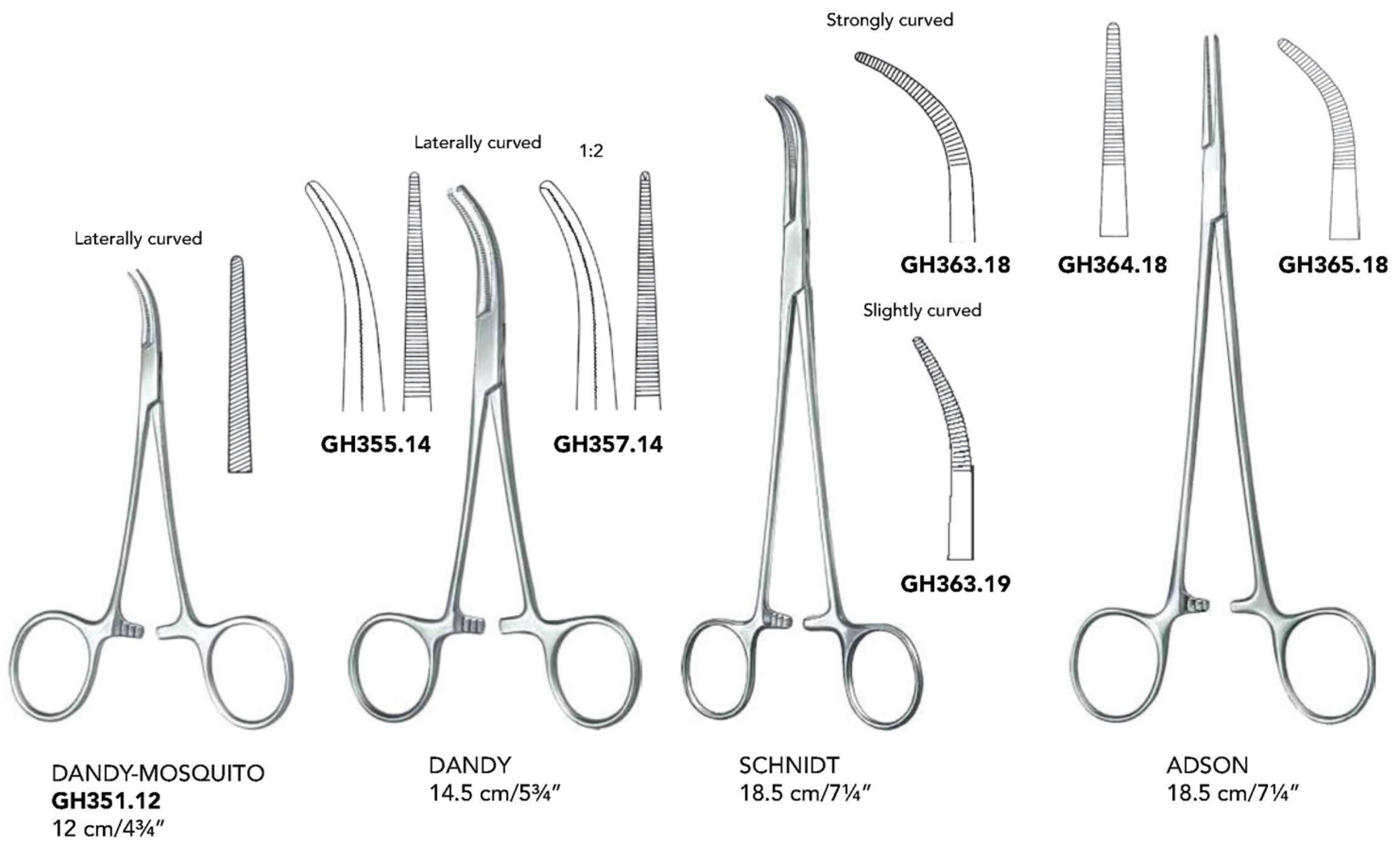

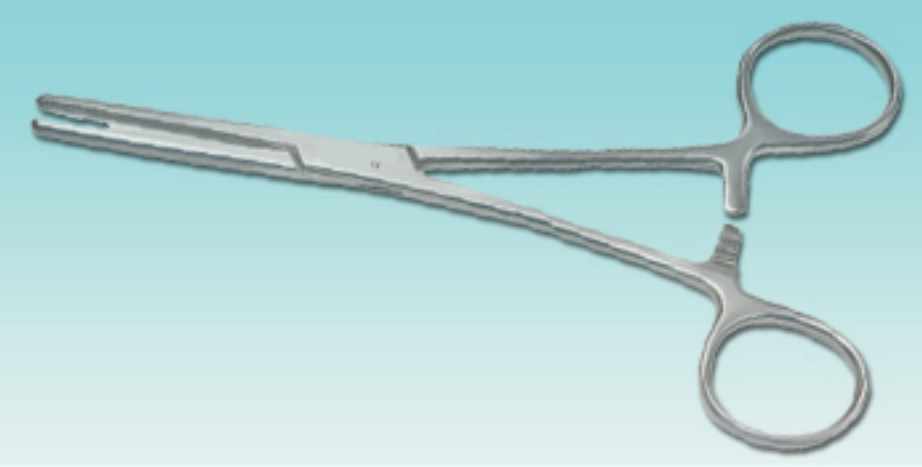

Haemostatic Forceps

Straight

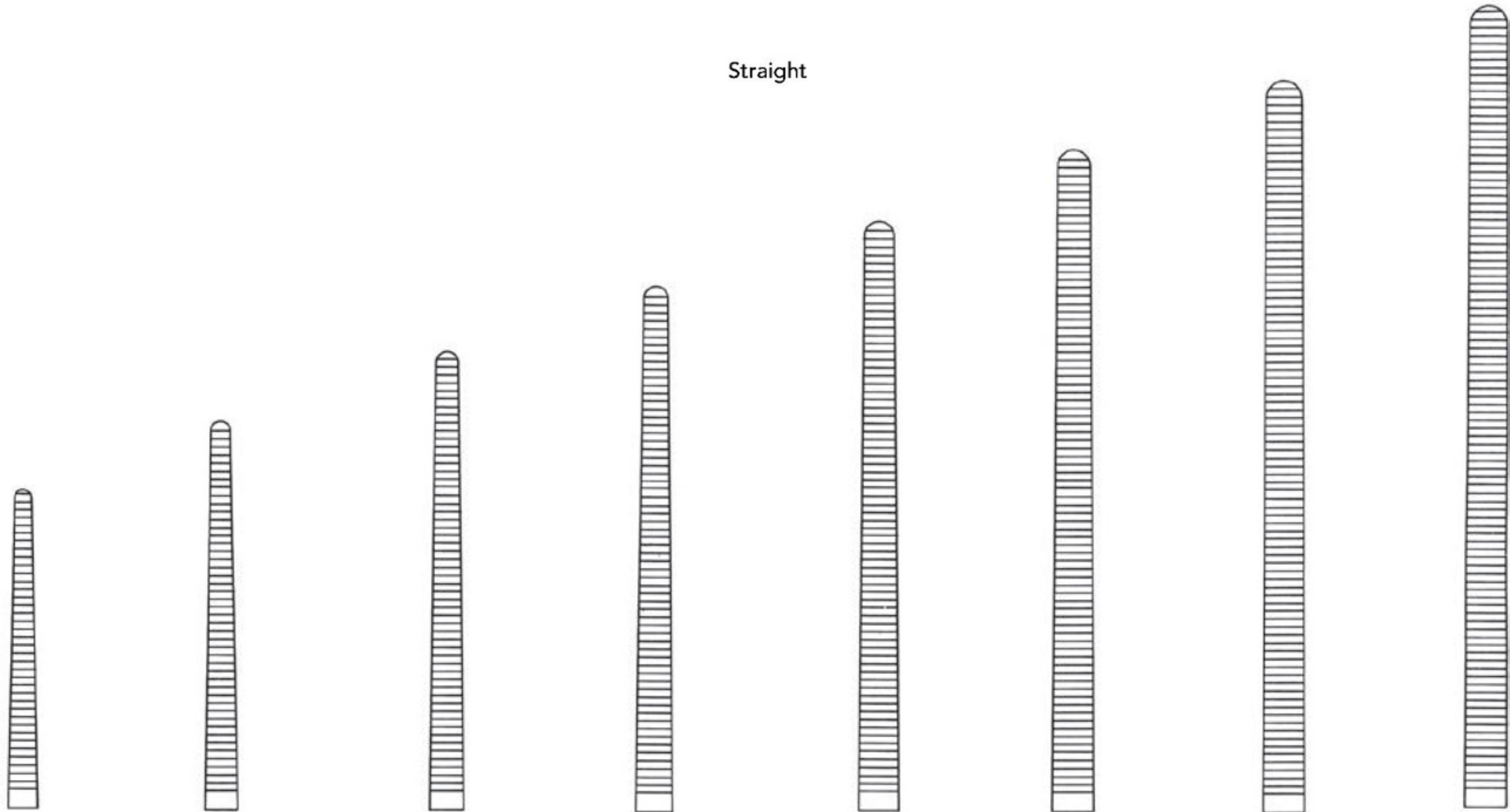

GH410.14
14.5 cm/5¾"

GH410.16
16.5 cm/6½"

GH410.18
18.5 cm/7¼"

GH410.20
20.5 cm/8¼"

GH410.22
22.5 cm/8¾"

GH410.24
24 cm/9½"

GH410.26
26 cm/10¼"

GH410.30
31 cm/12½"

Curved

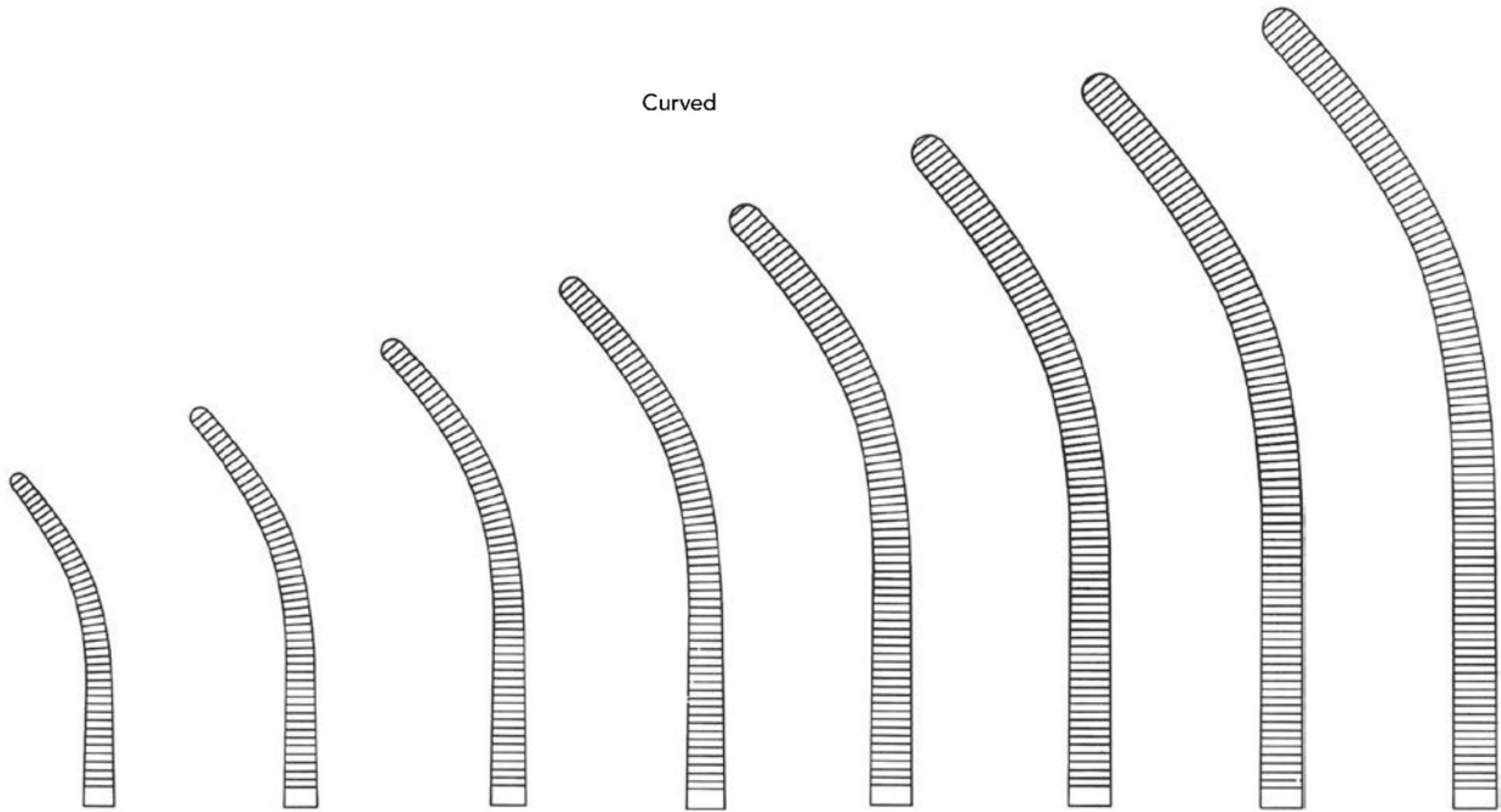

GH411.14
14.5 cm/5¾"

GH411.16
16.5 cm/6½"

GH411.18
18.5 cm/7¼"

GH411.20
20.5 cm/8¼"

GH411.22
22.5 cm/8¾"

GH411.24
24 cm/9½"

GH411.26
26 cm/10¼"

GH411.30
31 cm/12½"



PEAN (ROCHESTER)

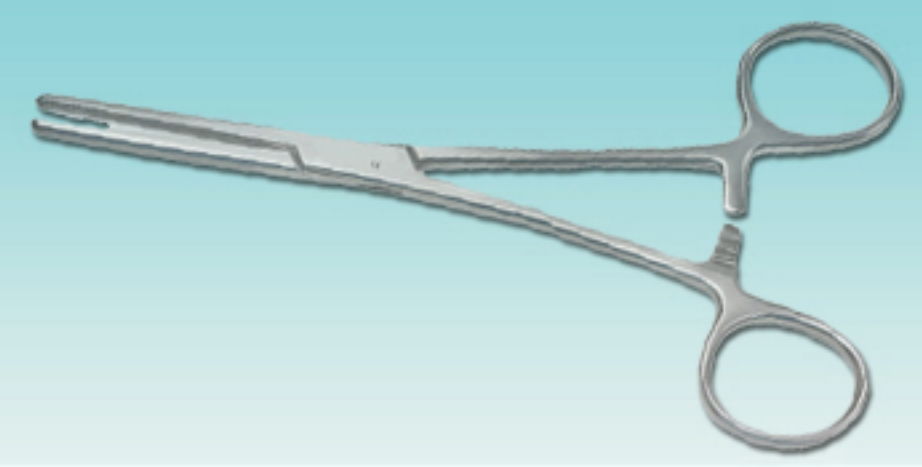

Haemostatic Forceps

Straight

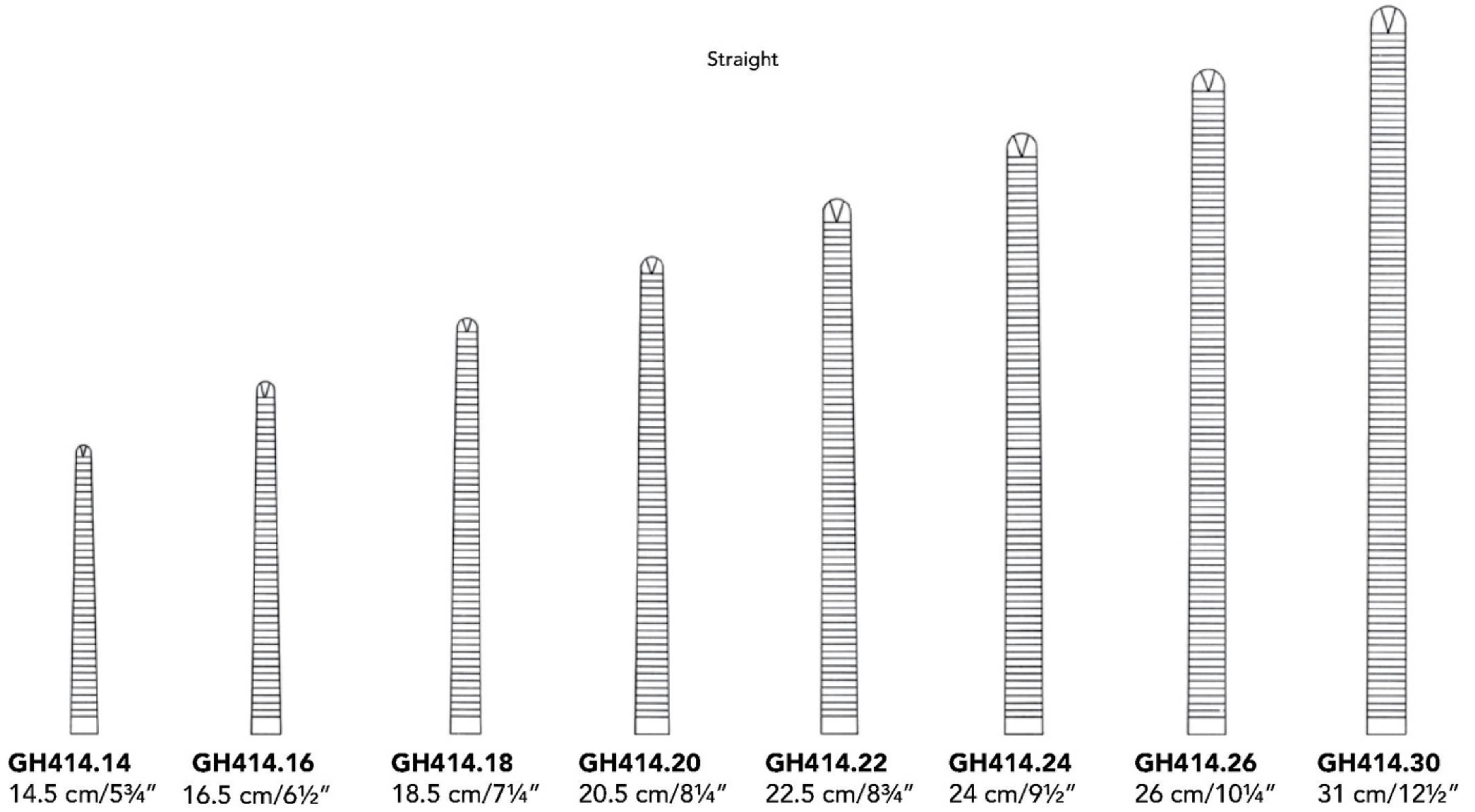



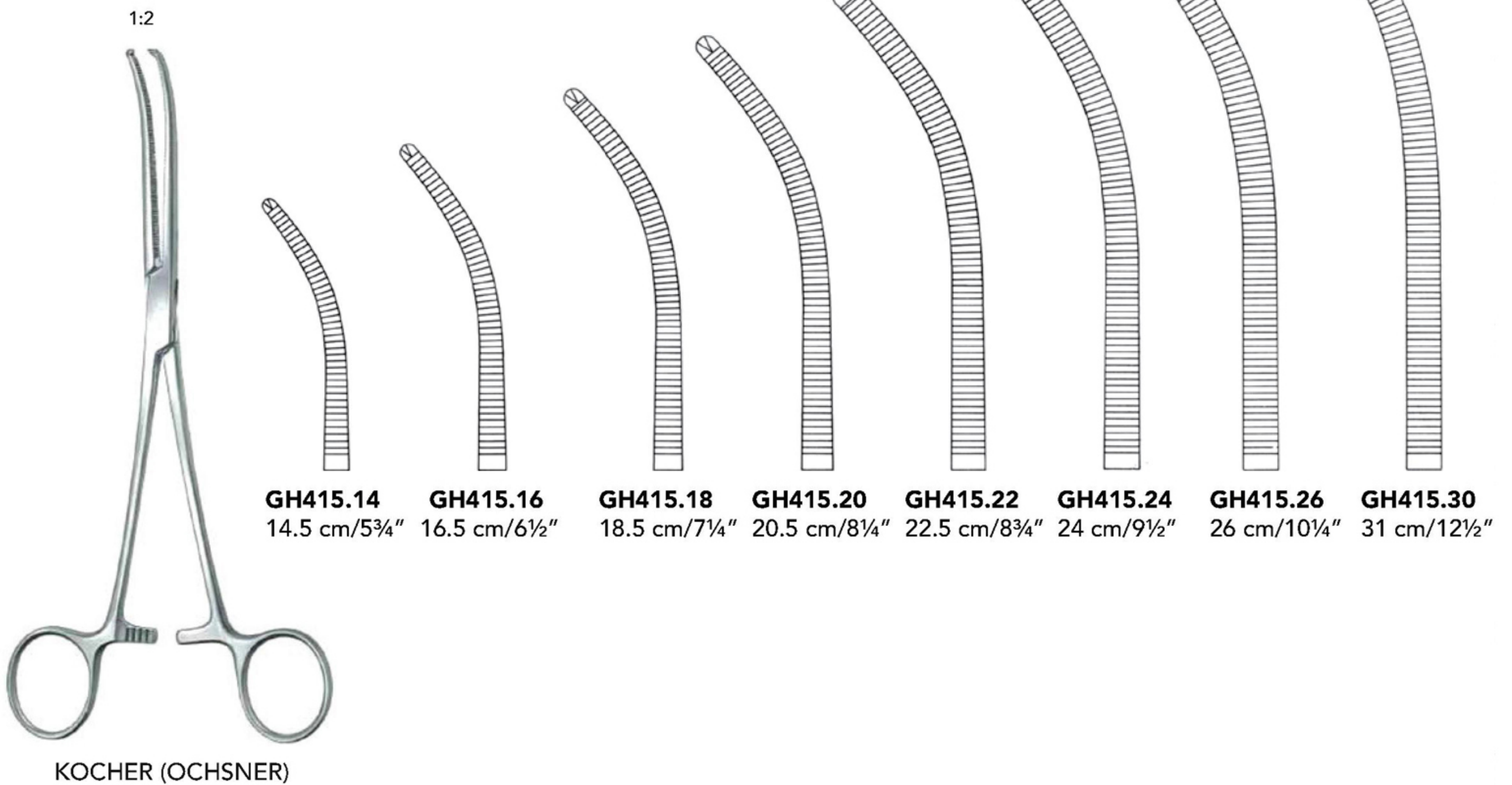

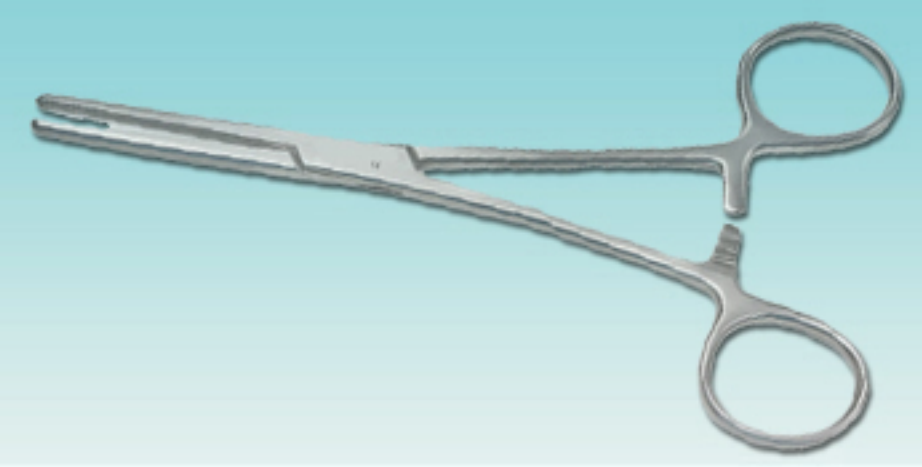



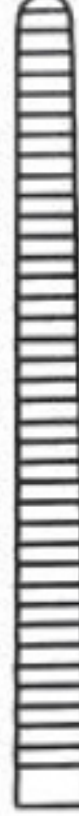
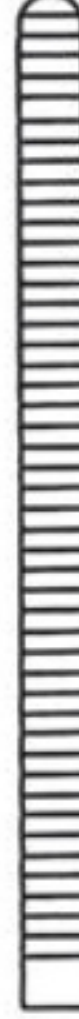

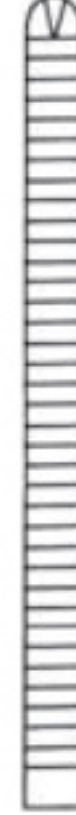
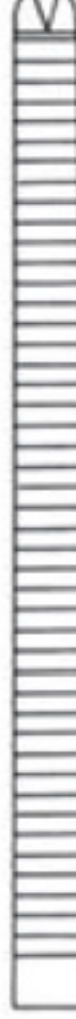



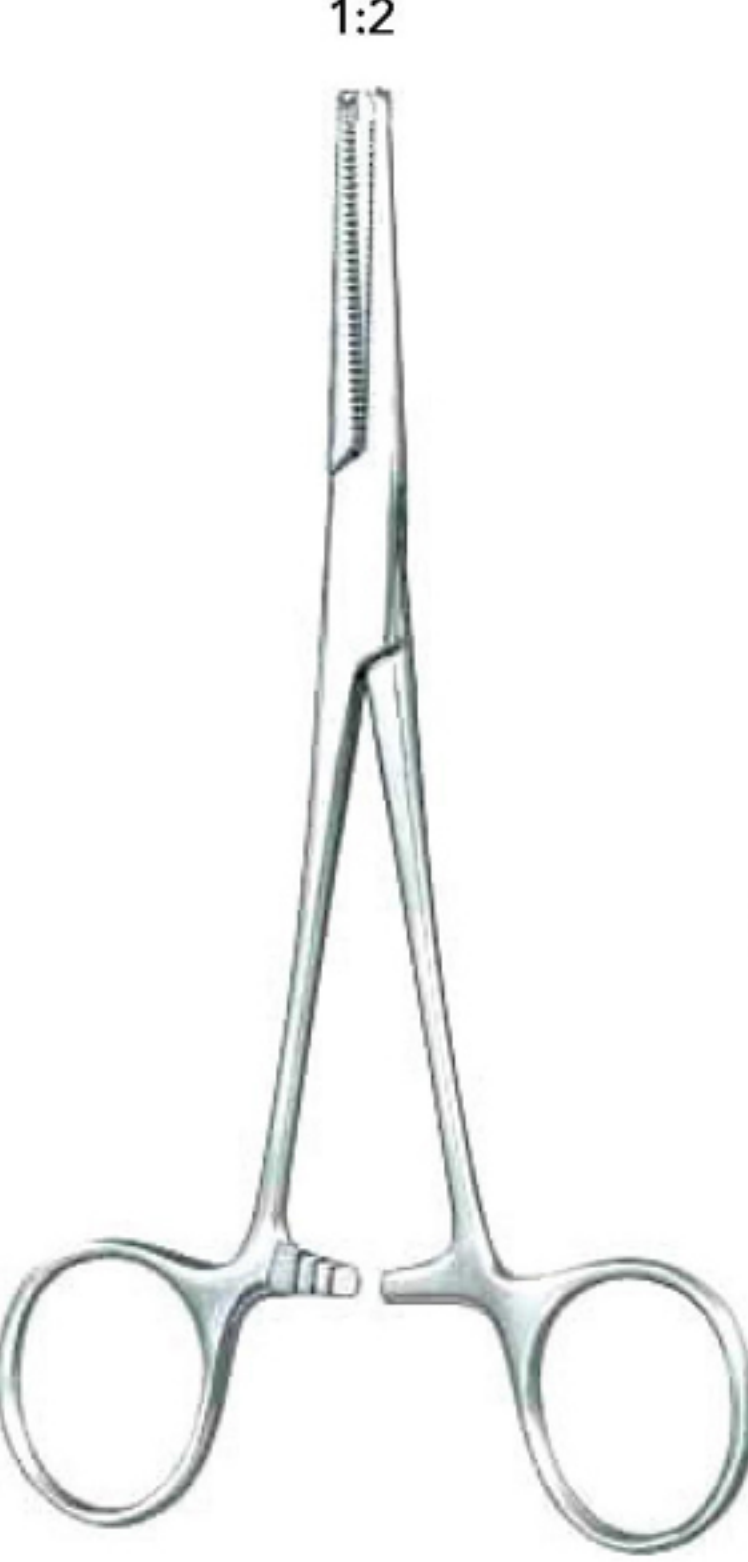
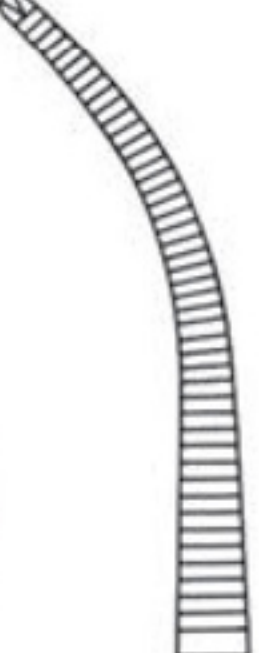



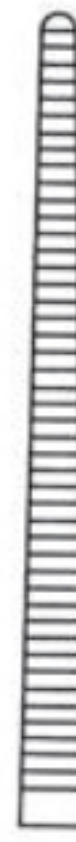



Curved





Haemostatic Forceps (Dissecting & Ligature Forceps)

							
	GH380.14 14.5 cm/5¾"	GH380.16 16.5 cm/6½"	GH380.18 18.0 cm/7"		GH382.14 14.5 cm/5¾"	GH382.16 16.5 cm/6½"	GH382.18 18.0 cm/7"
							
PEAN-NIPPON	GH381.14 14.5 cm/5¾"	GH381.16 16.5 cm/6½"	GH381.18 18.0 cm/7"	KOCHER-NIPPON	GH383.14 14.5 cm/5¾"	GH383.16 16.5 cm/6½"	GH383.18 18.0 cm/7"
							
	GH374.13 13.5 cm/5¼"	GH374.14 14.5 cm/5¾"	GH374.16 17 cm/6¾"		GH384.13 13 cm/5"	GH384.14 14 cm/5½"	GH384.16 16 cm/6¼"
							
PEAN	GH375.13 13.5 cm/5¼"	GH375.14 14.5 cm/5¾"	GH375.16 17 cm/6¾"	KOCHER	GH385.13 13 cm/5"	GH385.14 14 cm/5½"	GH385.16 16 cm/6¼"

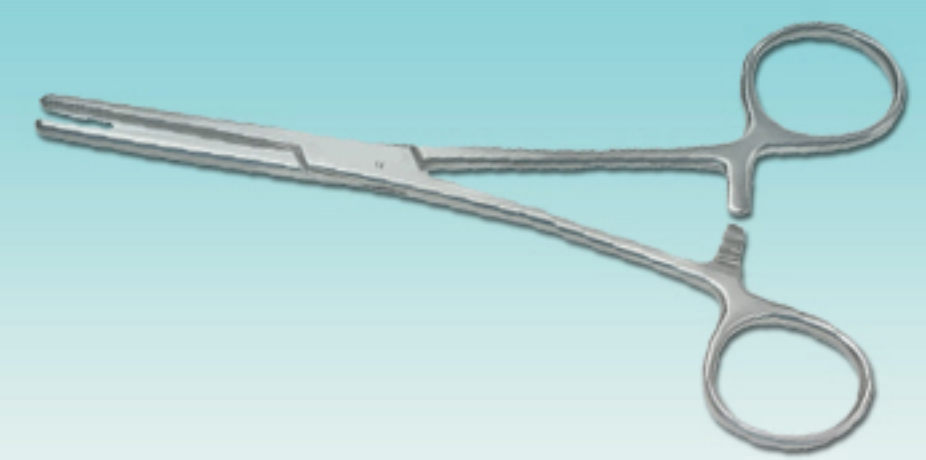

Haemostatic Forceps (Dissecting & Ligature Forceps)

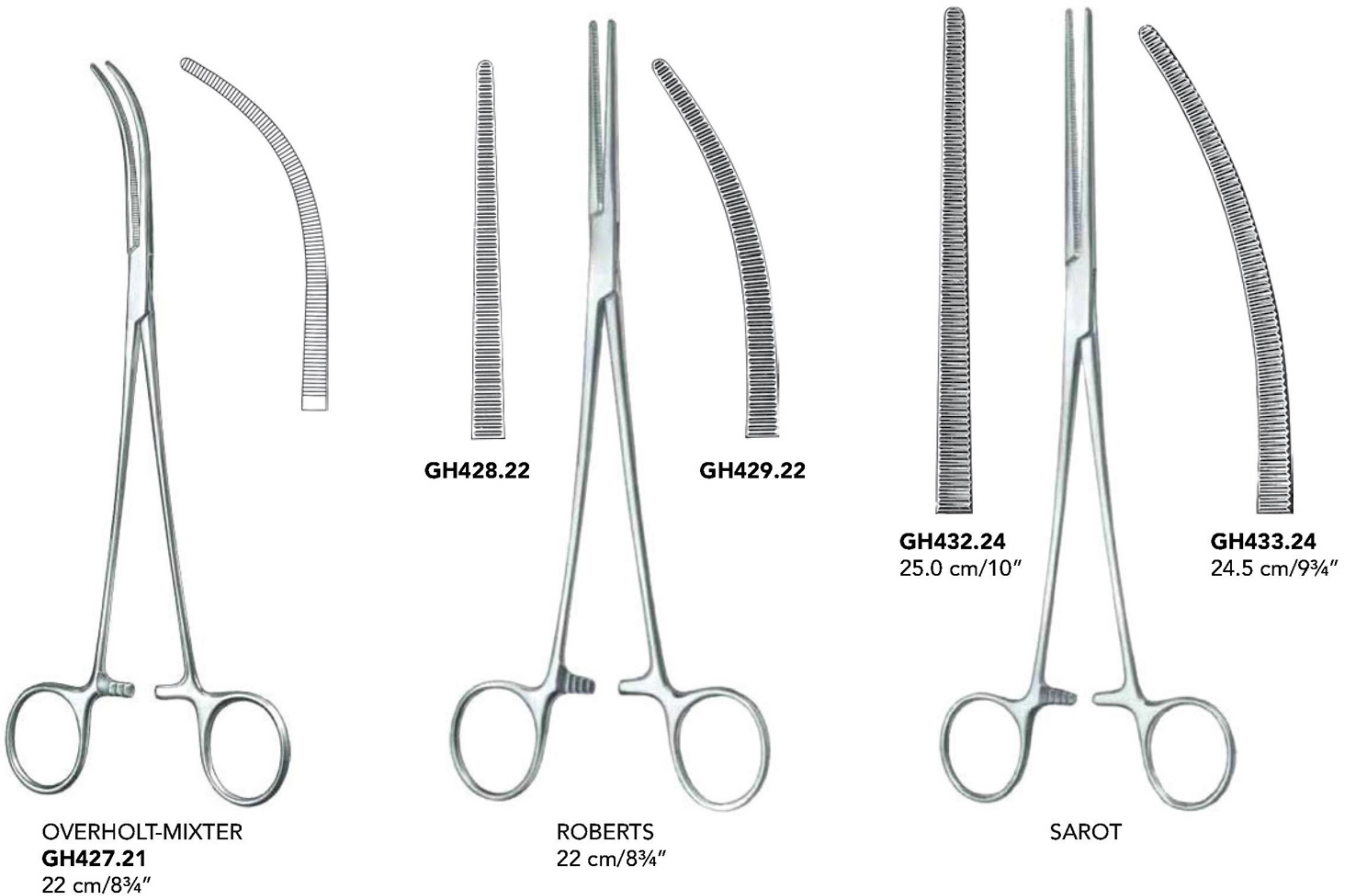
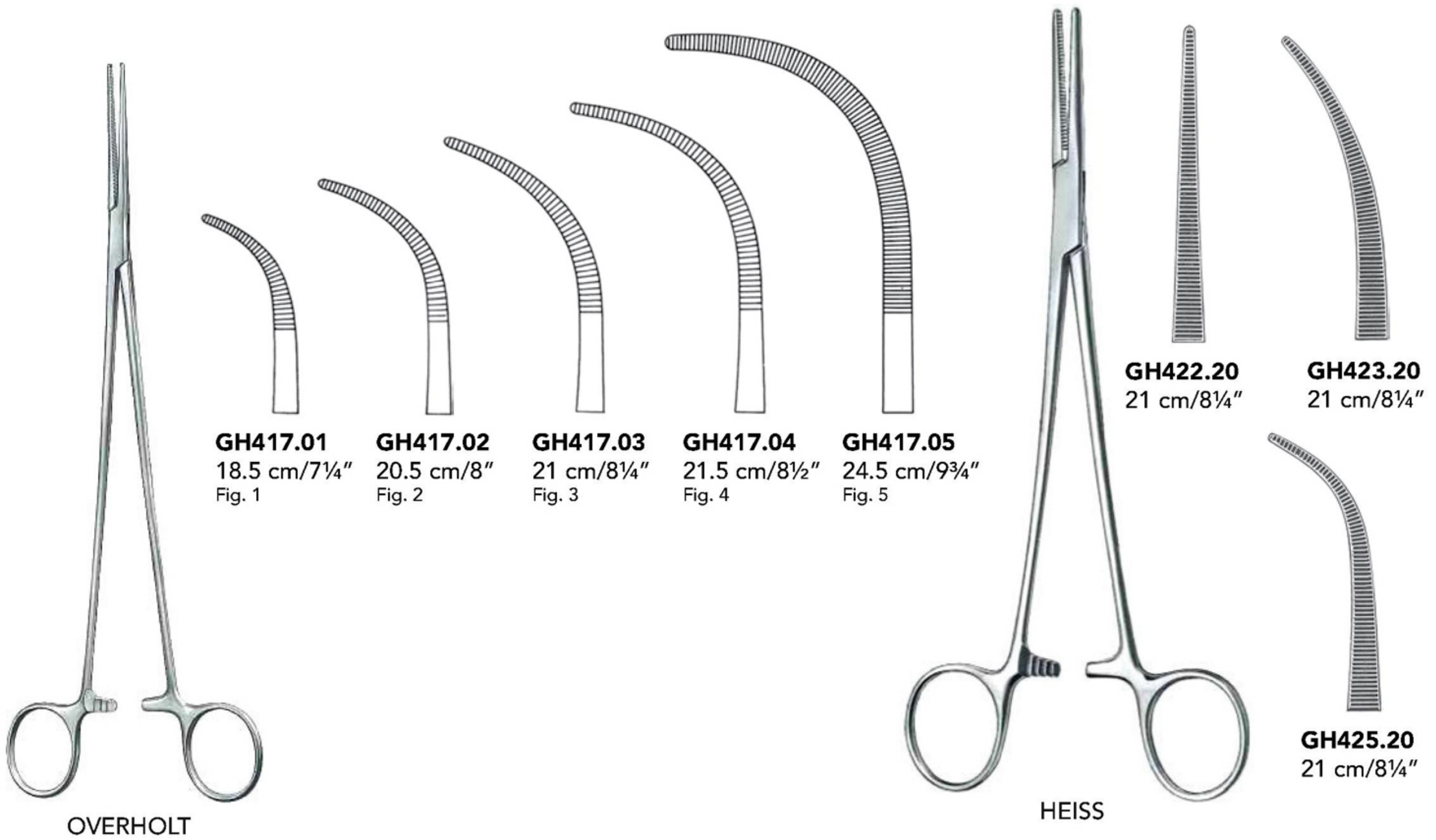

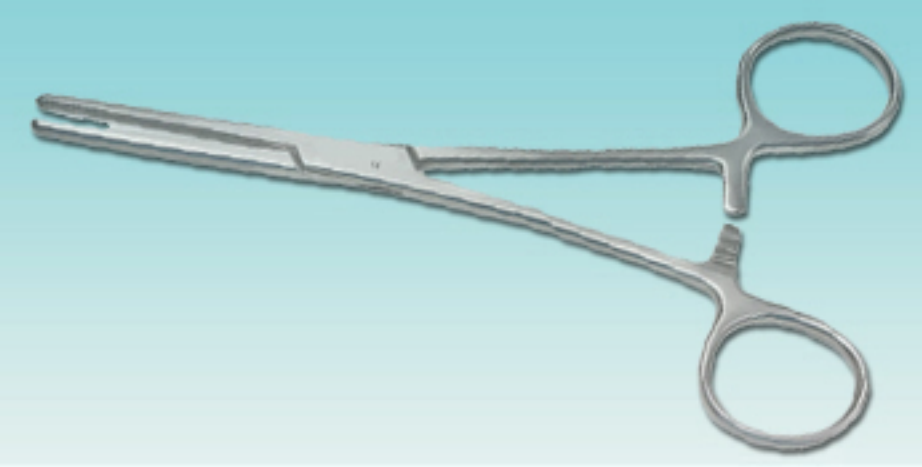

Haemostatic Forceps (Dissecting & Ligature Forceps)

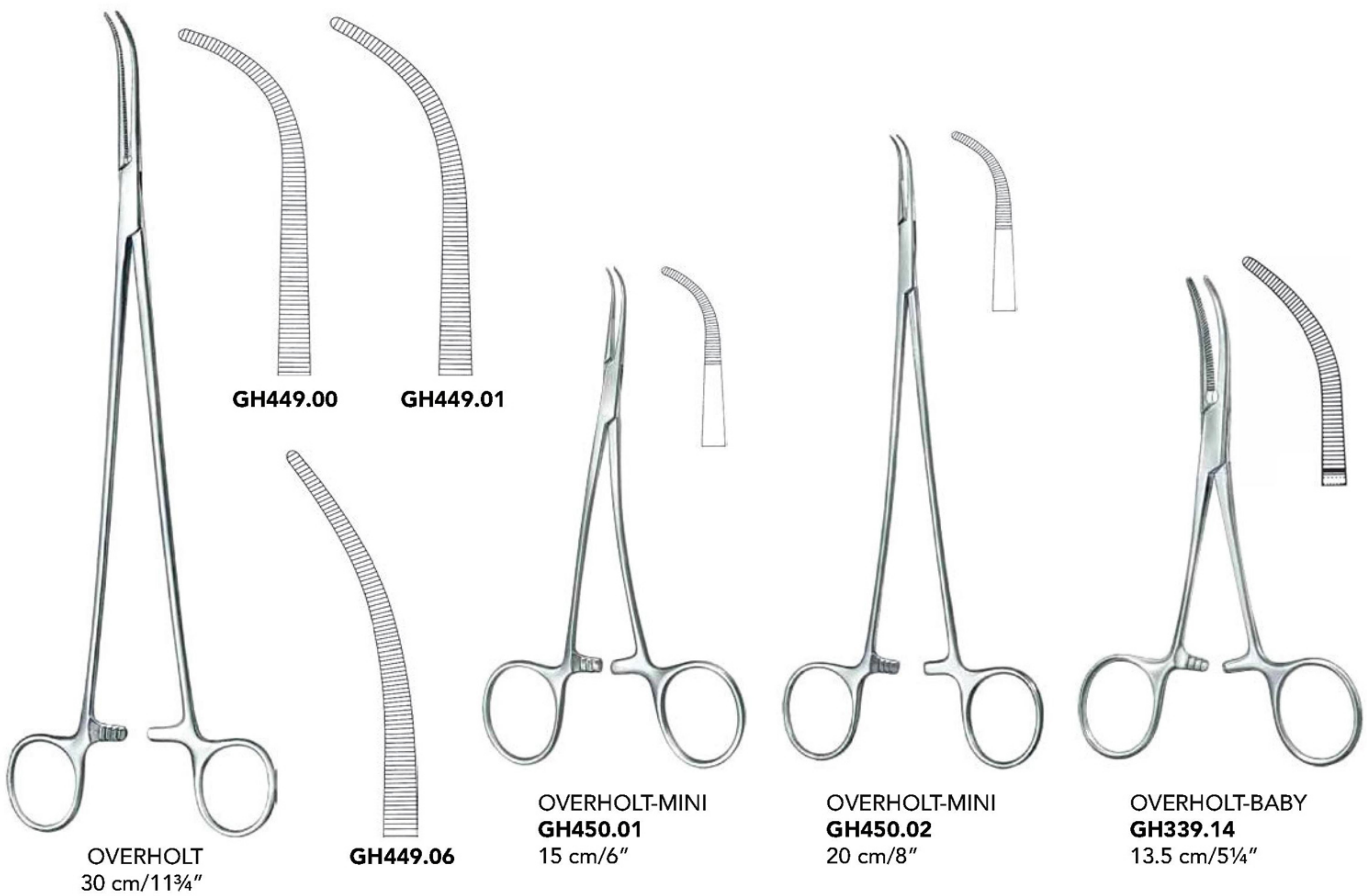
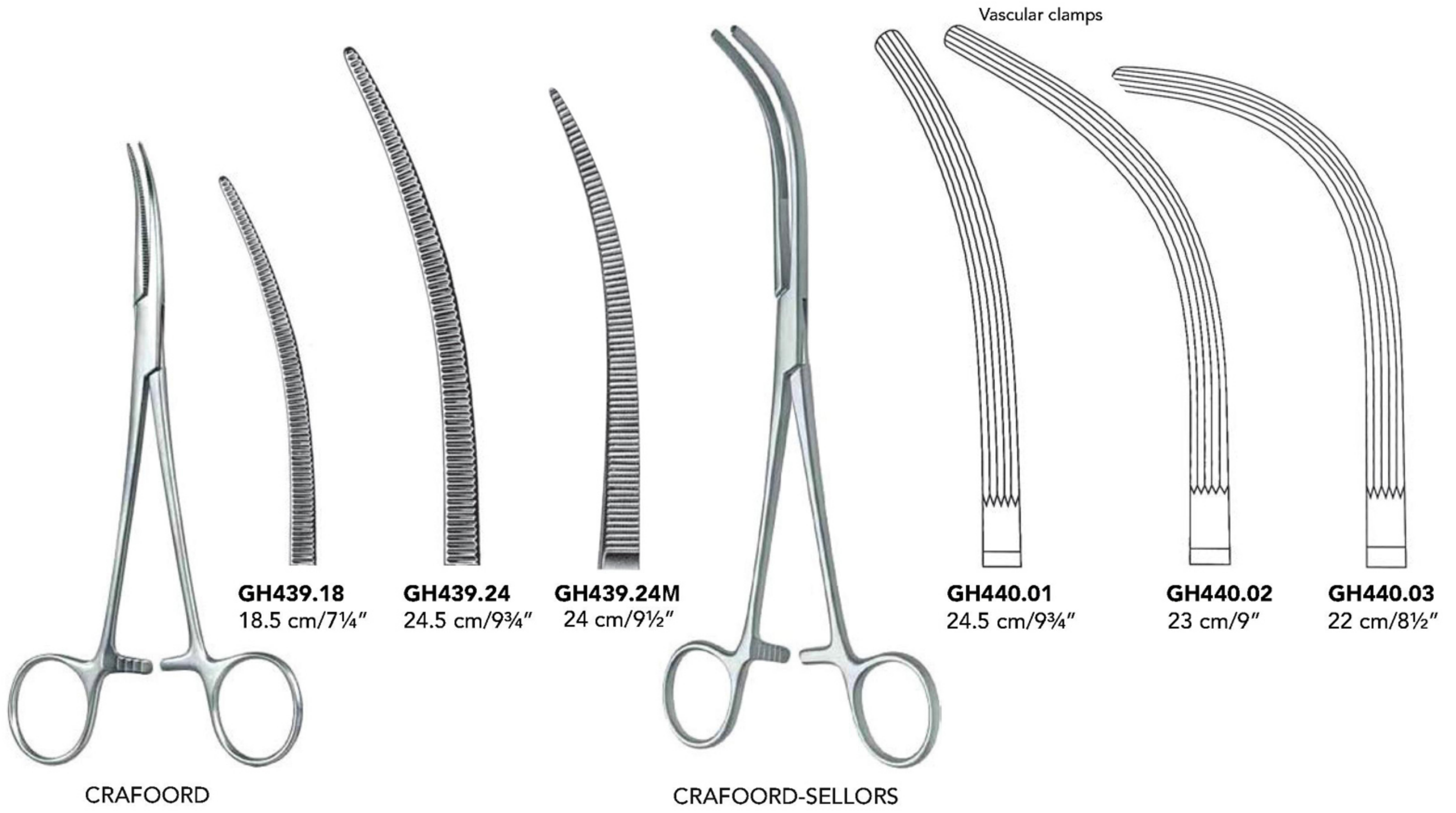

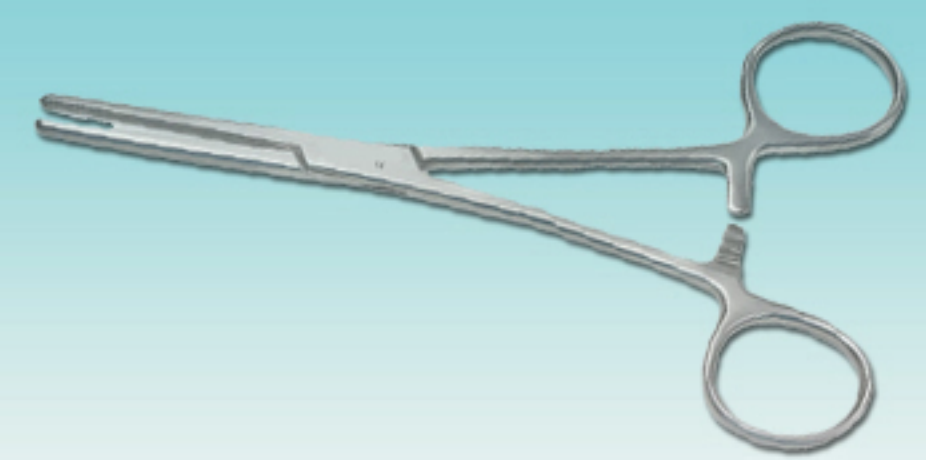

Haemostatic Forceps (Dissecting & Ligature Forceps)

OVERHOLT-FINO

- GH448.00** 21.5 cm/8½"
- GH448.01** 22 cm/8½"
- GH448.02** 22.5 cm/8¾"
- GH448.03** 23 cm/9"
- GH448.06** 22.5 cm/8¾"

GEMINI

- 13 cm/5" **GH451.13**
- 16 cm/6¼" **GH451.16**
- 18 cm/7" **GH451.18**
- 21 cm/8¼" **GH451.20**
- 23 cm/9" **GH451.23**
- 25 cm/10" **GH451.25**
- 28 cm/11" **GH451.28**

MINI-GEMINI

- 18 cm/7" **GH453.18**
- 23 cm/9" **GH453.22**
- 25 cm/10" **GH453.25**
- 28.5 cm/11¼" **GH453.28**

RUMEL

- 24 cm/9½"
- GH461.01**
- GH461.02**
- GH461.03**
- GH461.04**
- GH461.05**

BENGOLEA

- GH390.20** 21.5 cm/8½"
- GH390.26** 26 cm/10¼"
- GH391.20** 21.5 cm/8½"
- GH391.26** 26 cm/10¼"
- GH392.20** 21.5 cm/8½"
- GH392.26** 26 cm/10¼"
- GH393.20** 21.5 cm/8½"
- GH393.26** 26 cm/10¼"

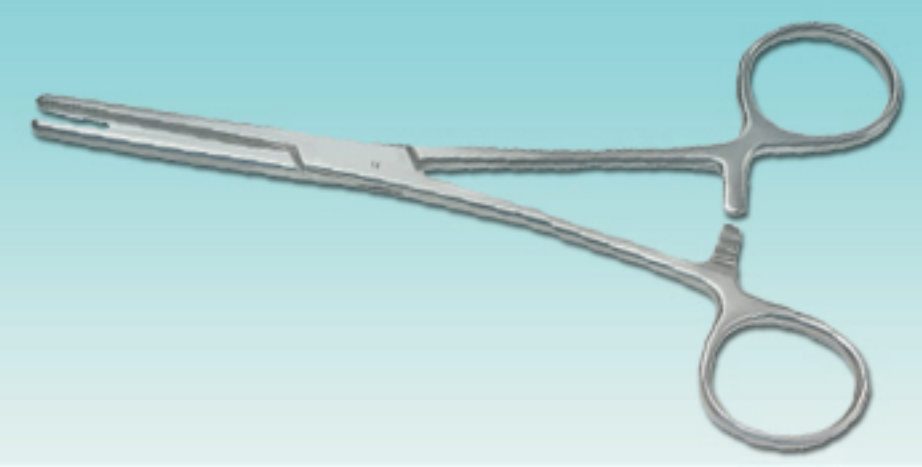

Haemostatic Forceps (Dissecting & Ligature Forceps)



ZENKER

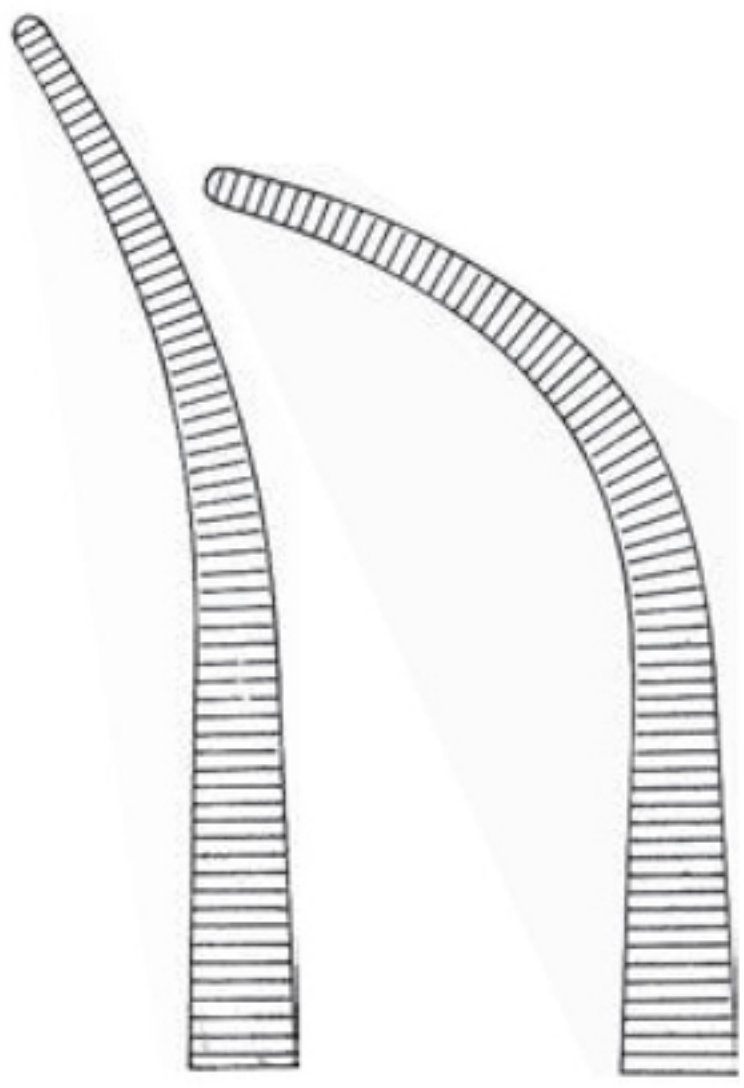

GH469.01 29.5 cm/11½"
GH469.02 28.5 cm/11¼"



O'SHAUGHNESSY

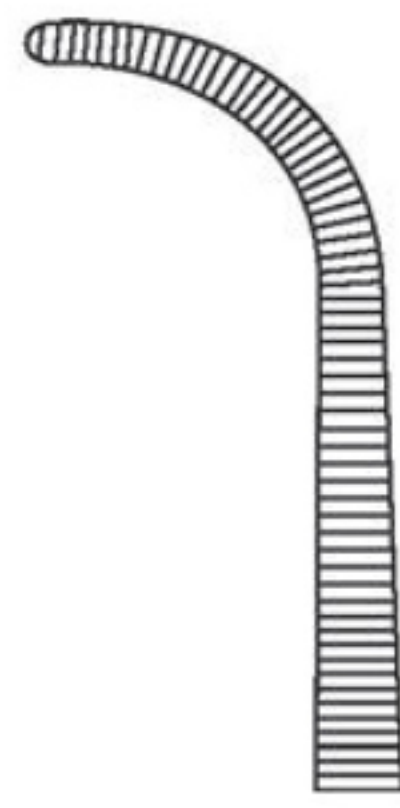

GH479.14
15 cm/6"

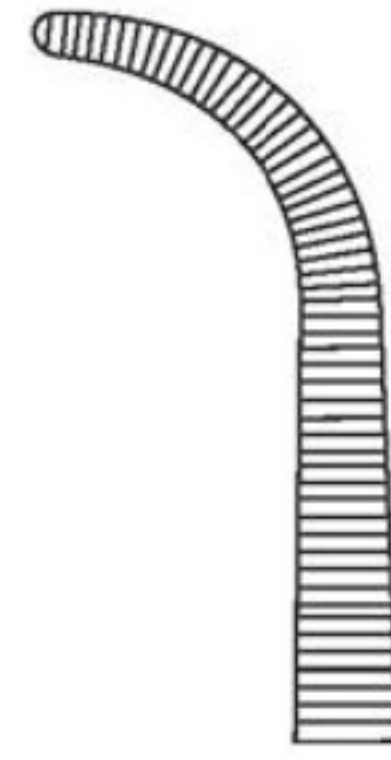

GH479.17
18 cm/7"



GH479.19
18.5 cm/7¼"

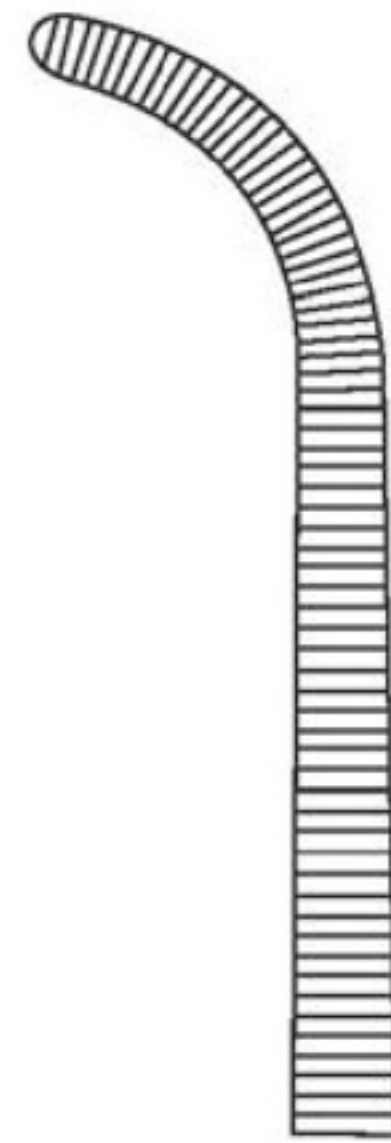

GH479.20
20 cm/6"



GH479.23
23 cm/9"



GH479.26
26 cm/10¼"



MIXTER-BABY
GH471.14
13 cm/5"



KANTROWITZ



GH1000.04 19 cm
GH1000.05 24 cm
GH1000.06 27,5 cm



MIXTER

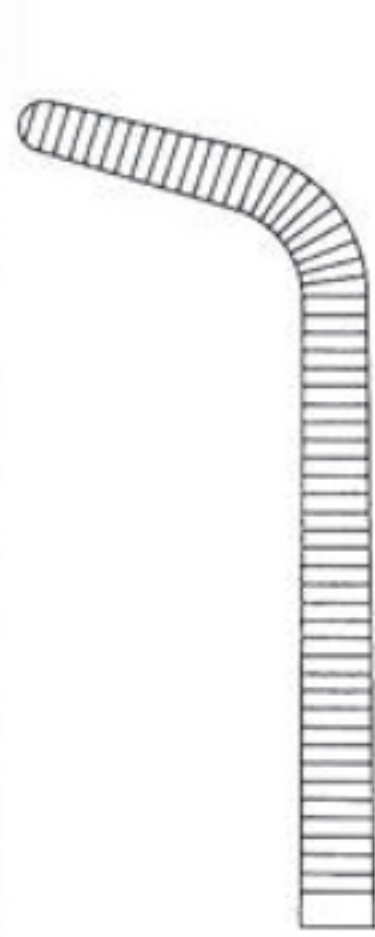

GH473.15
16 cm/6¼"

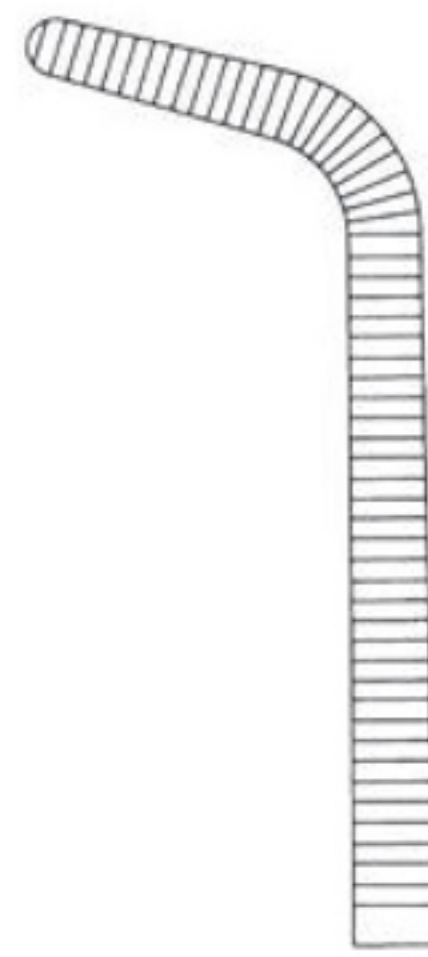

GH473.17
17.5 cm/7"



MIXTER-BABY
GH419.18
18.5 cm/7¼"

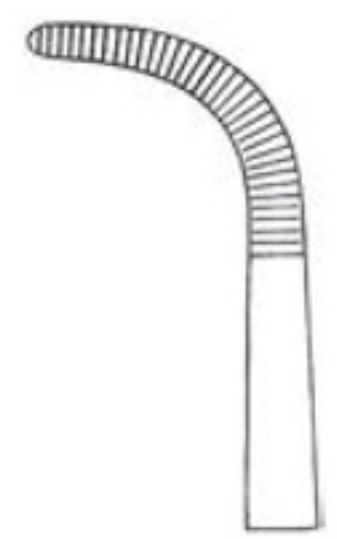

GH421.18
18.0 cm/7"



GH421.14
14.5 cm/5¾"



ADSON-BABY

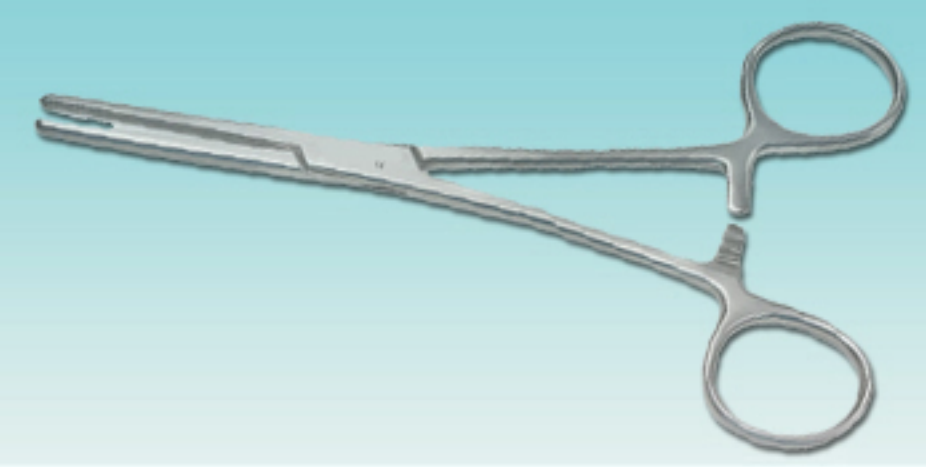

Haemostatic Forceps (Dissecting & Ligature Forceps)

Bile duct clamps



MIXTER

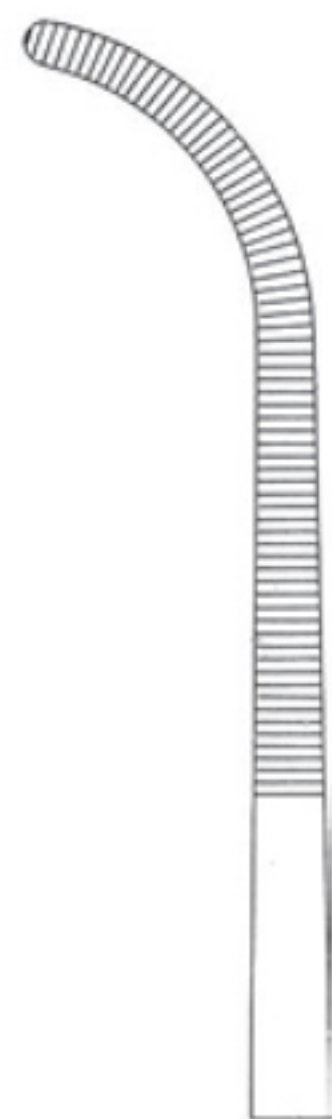

GH483.22
22.5 cm/8¾"



MIXTER

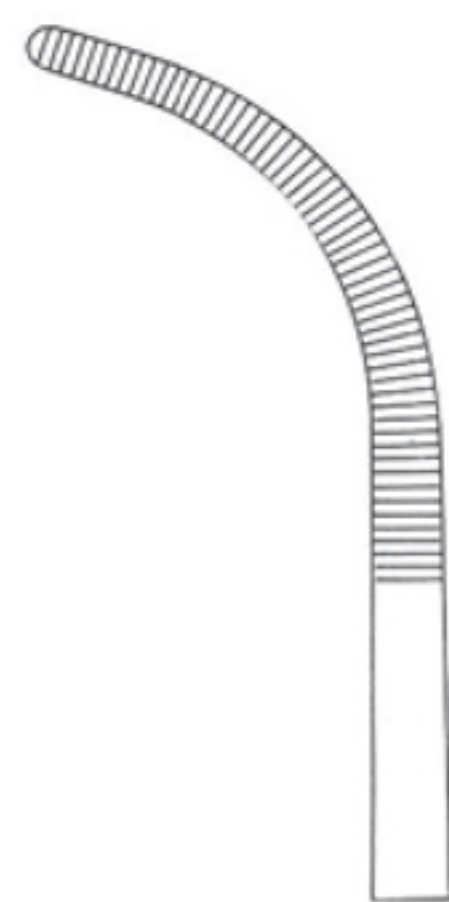

GH485.23
23 cm/9"



WIKSTROEM

21.0 cm/8¼" **GH487.21**
24.5 cm/9½" **GH487.24**



MIXTER

22.5 cm/8¾" **GH491.22**
26 cm/10¼" **GH491.25**
28 cm/11" **GH491.28**

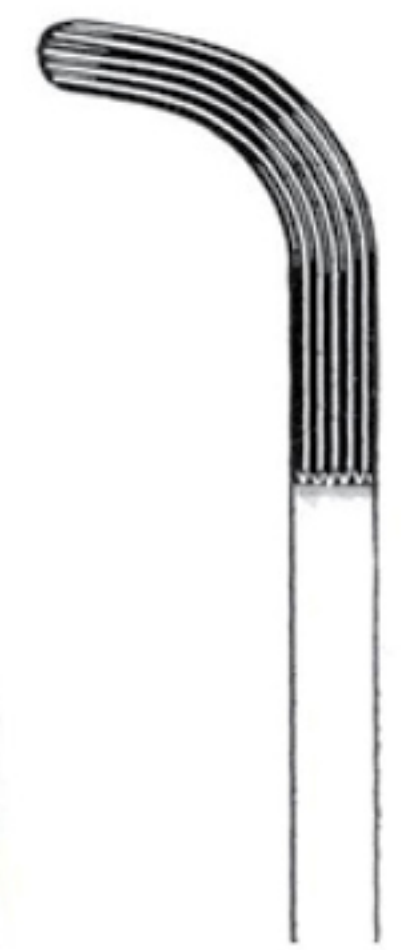

MCQUIGG-MIXTER



GH497.22
23.5 cm/9¼"



MIXTER-BABY
13.5 cm/5¼"



GH303.01

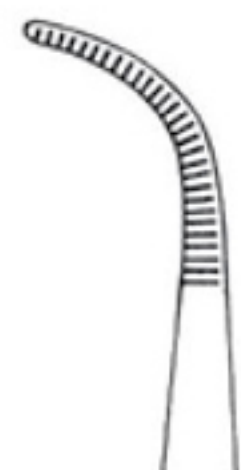

GH303.02



Micro-ADSON
GH304.14
14 cm/5½"



BABY-ADSON
GH305.18
18 cm/7"

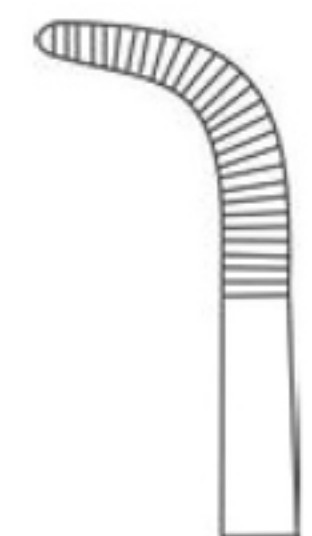

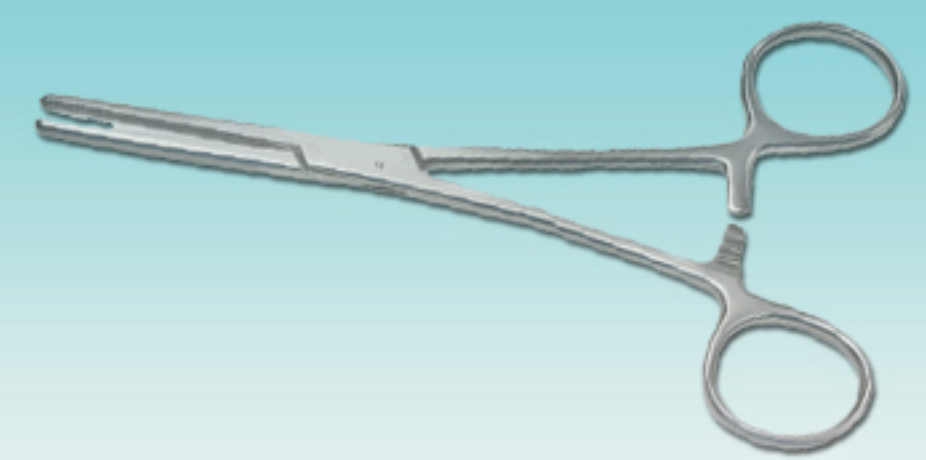

Haemostatic Forceps (Dissecting Forceps, Bile Duct Clamps)

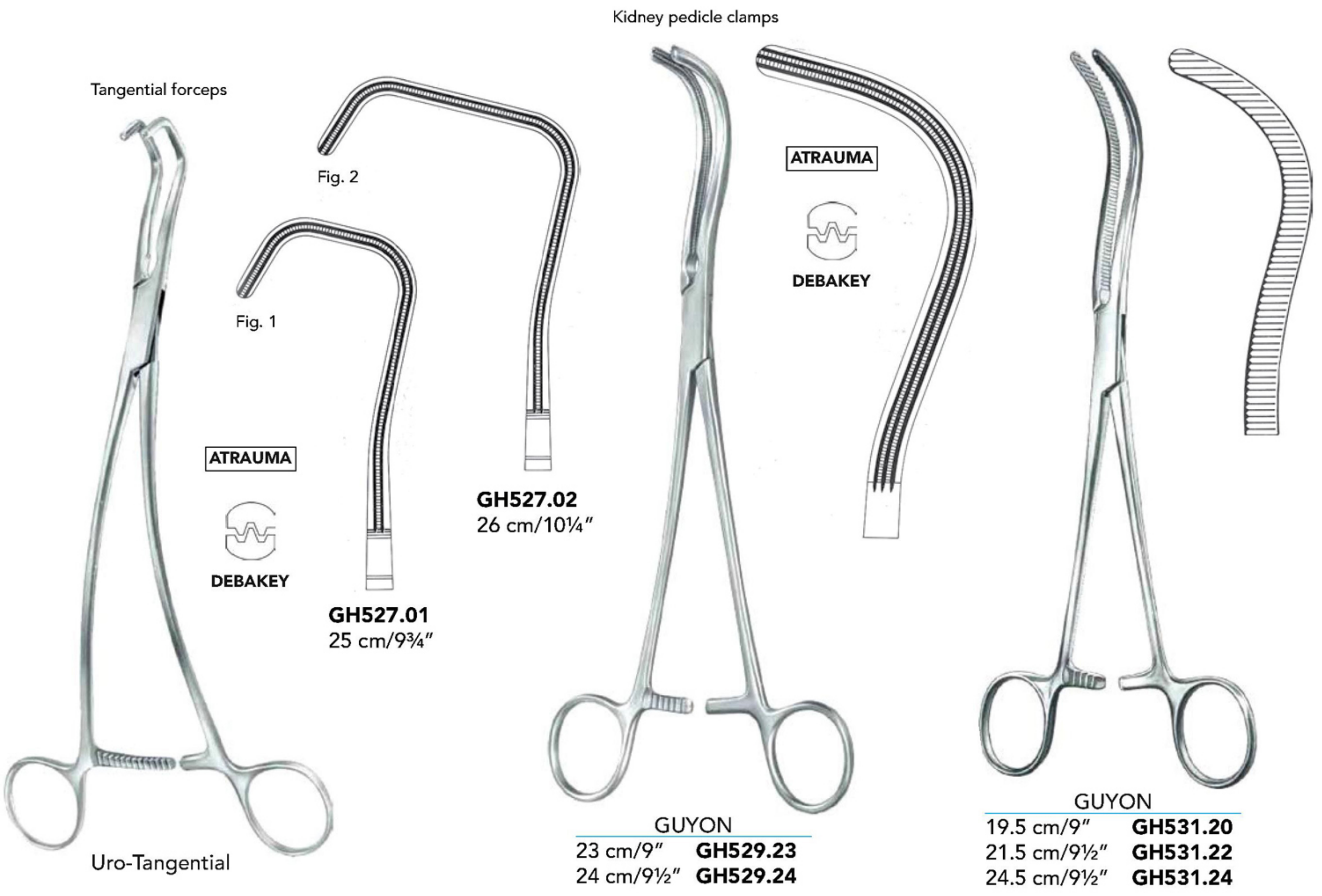

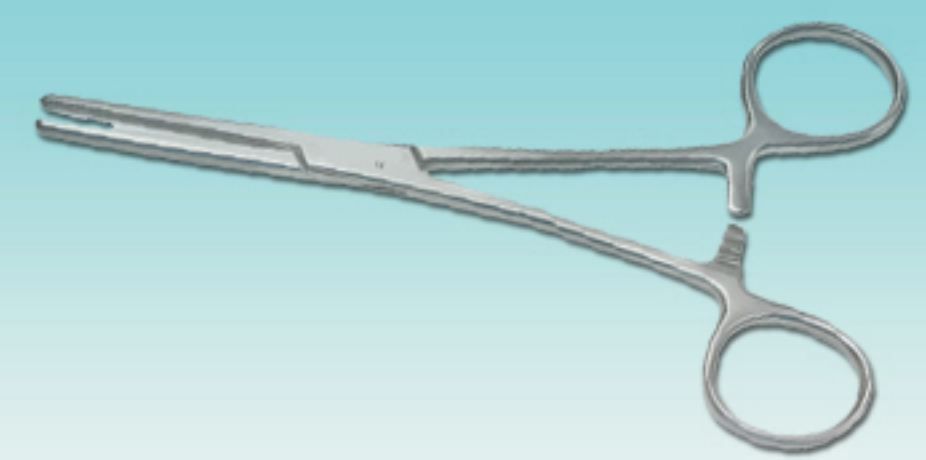

Haemostatic Forceps (Dissecting Forceps)



GUYON
GH533.23
23 cm/9"

DESJARDINS
GH571.21
21 cm/8¼"

KELLY

Bile Duct Clamp

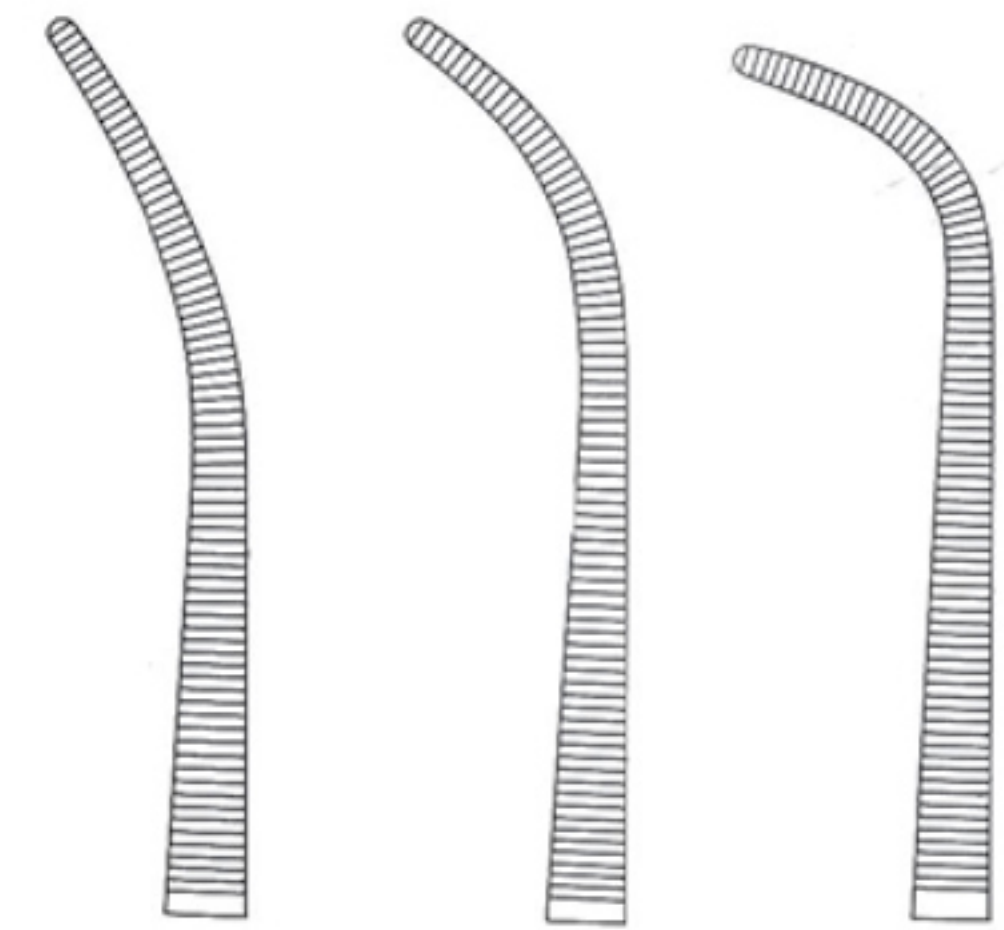

	Fig. 1	Fig. 2	Fig. 3
19 cm/7½"	GH577.19	GH579.19	GH581.19
22.5 cm/9"	GH577.22	GH579.22	GH581.22
23 cm/9"	GH577.24	GH579.24	GH581.24



LAWRENCE
GH583.28
28 cm/11"



MEEKER
GH585.28
28 cm/11"



NEGUS



GH595.19
19 cm/7½"

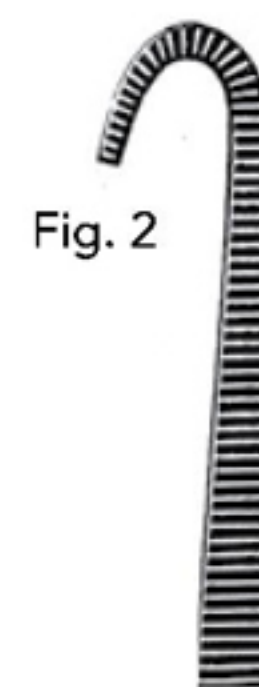

GH597.19
20 cm/8"

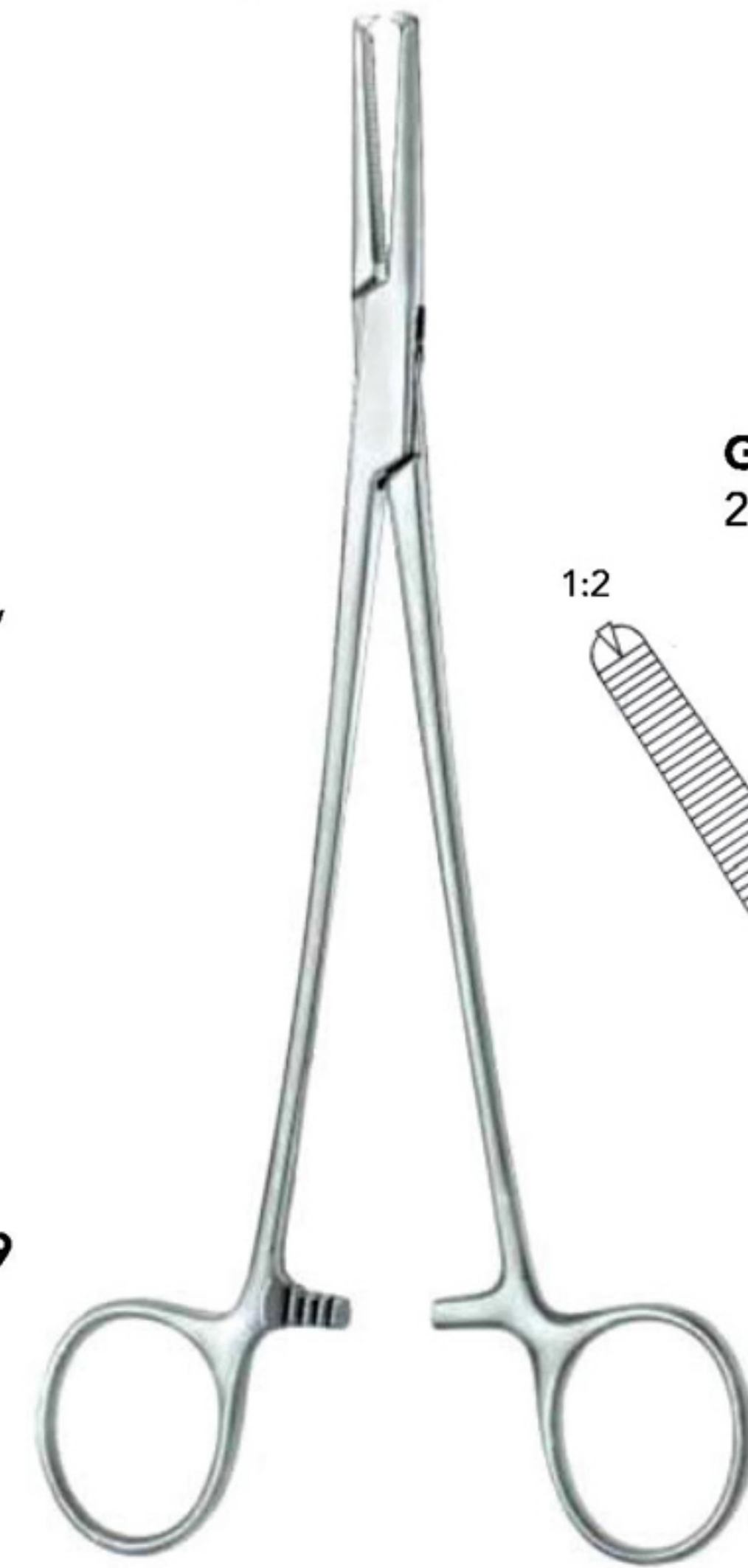

PHANEUF

Hysterectomy forceps



GH600.21
20.5 cm/8"

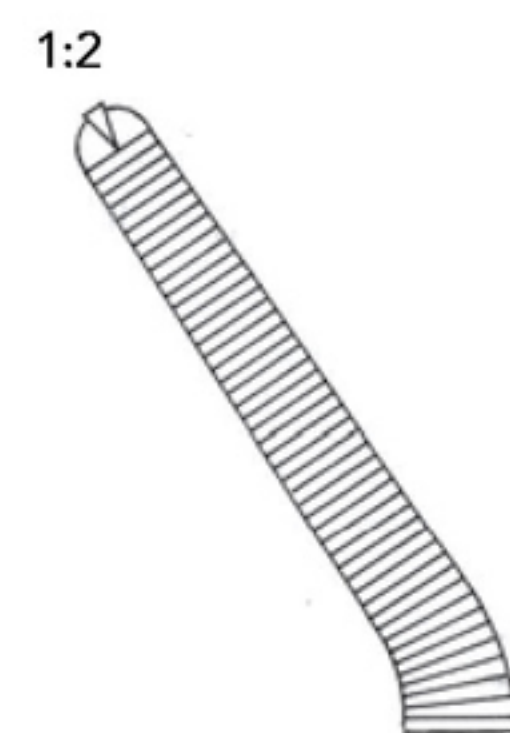

GH601.21
20.5 cm/8"

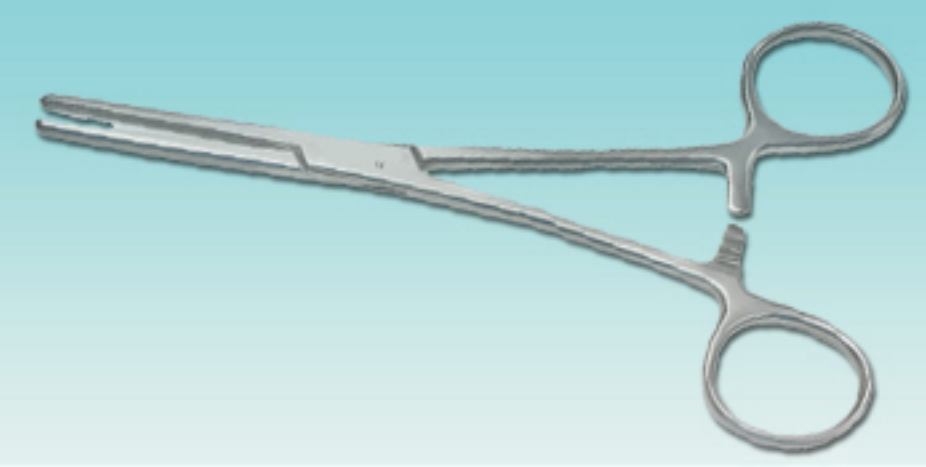

Haemostatic Forceps (Hysterectomy Forceps, Bile Duct Clamps)

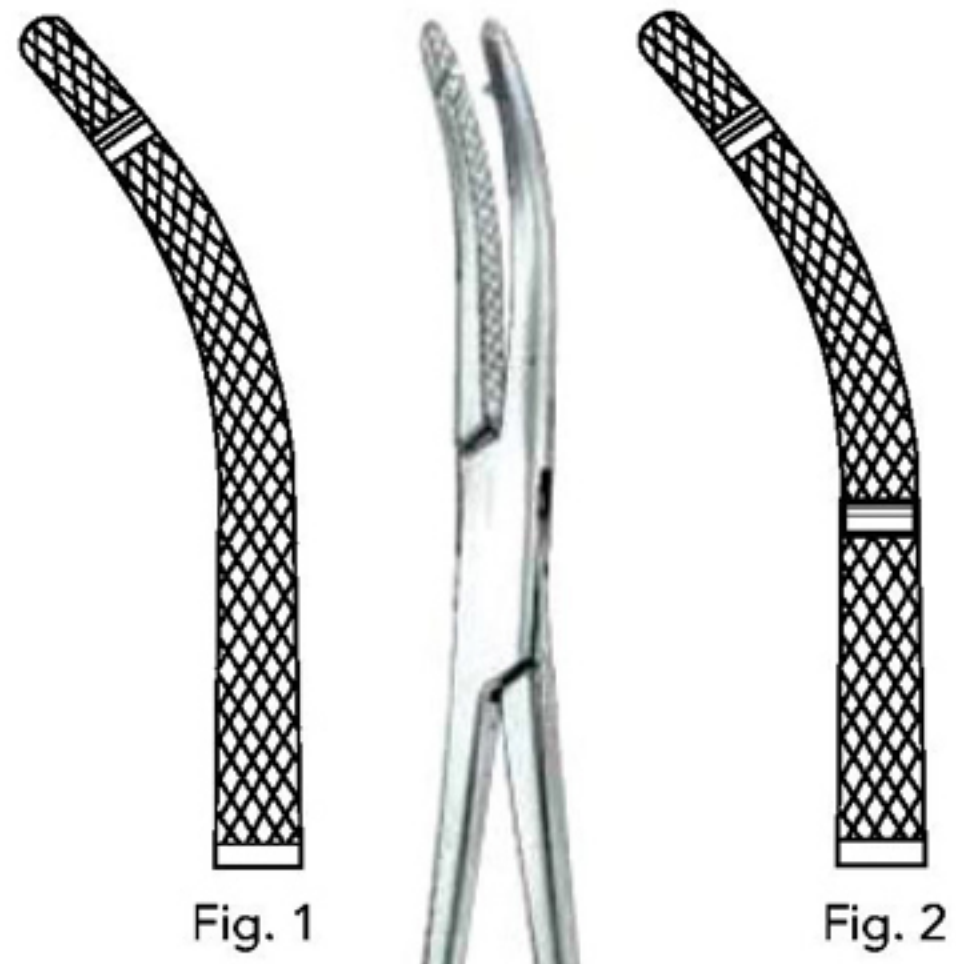
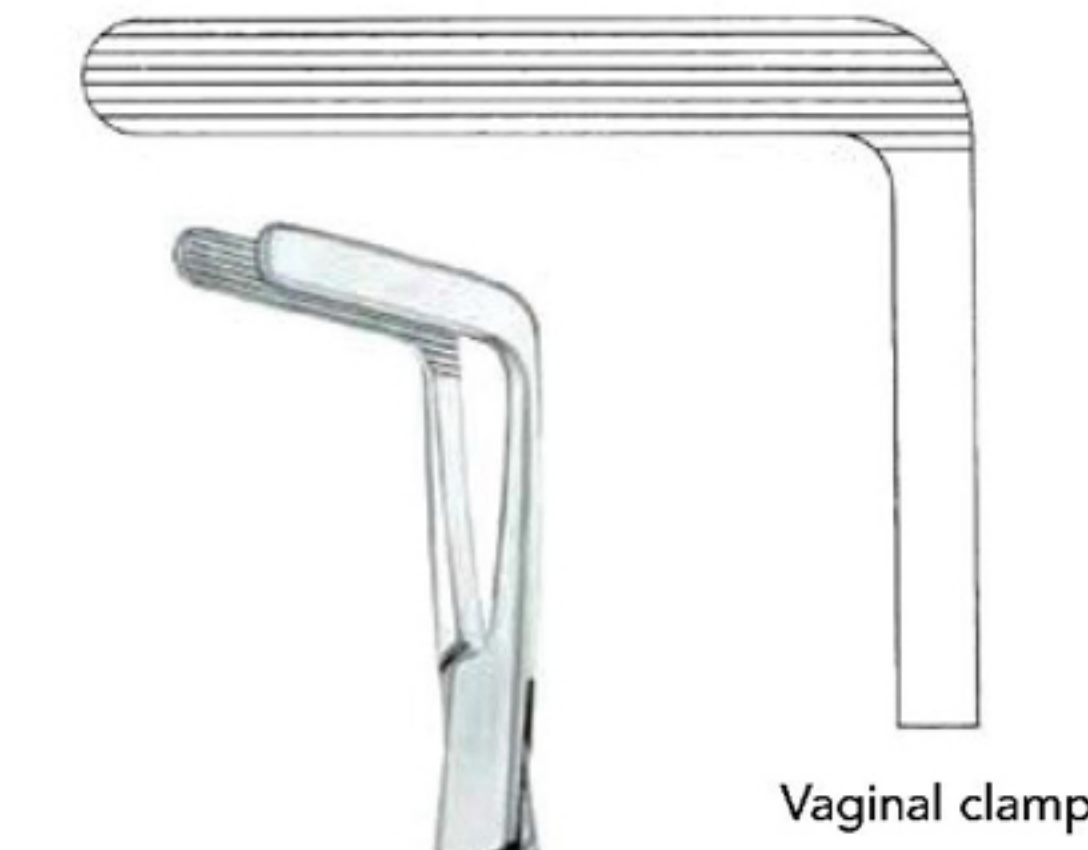

Fig. 1

Fig. 2

HEANEY

19.5 cm/7"	GH613.19	GH615.19
21.0 cm/8¼"	GH613.21	GH615.21
23.0 cm/9"	GH613.23	GH615.23



Vaginal clamp



WERTHEIM-CULLEN
GH625.21
21 cm/8¼"



MOYNIHAN

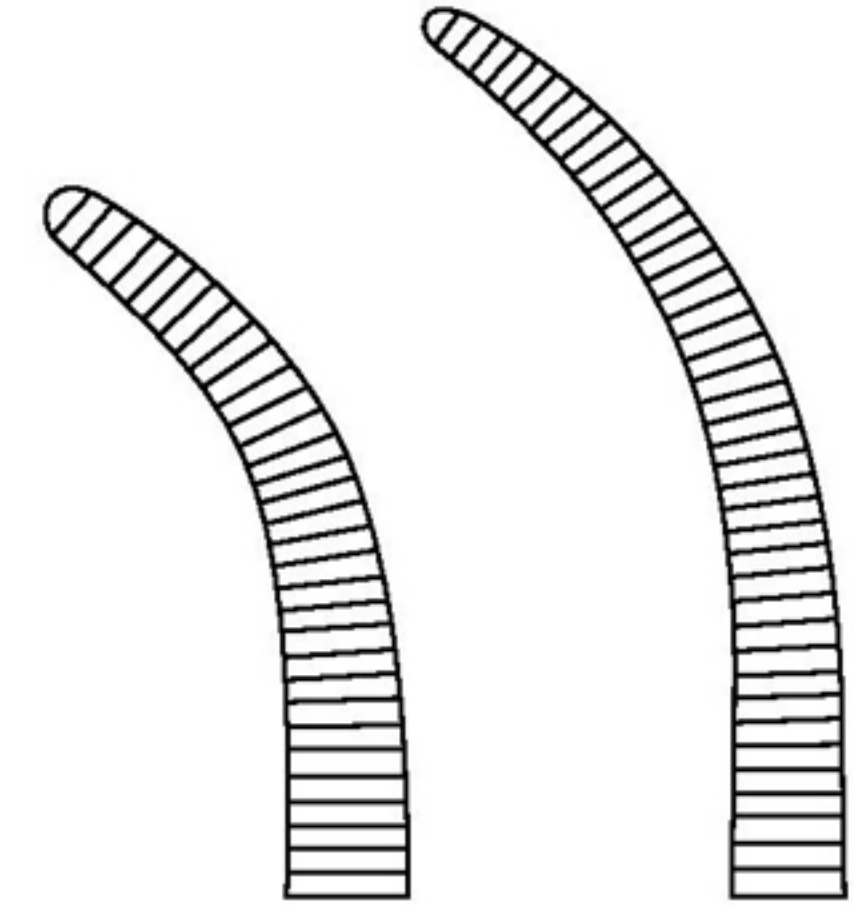

GH671.23
23 cm/9"

GH673.24
24 cm/9½"



ROGERS

ATRAUMA



DEBAKEY

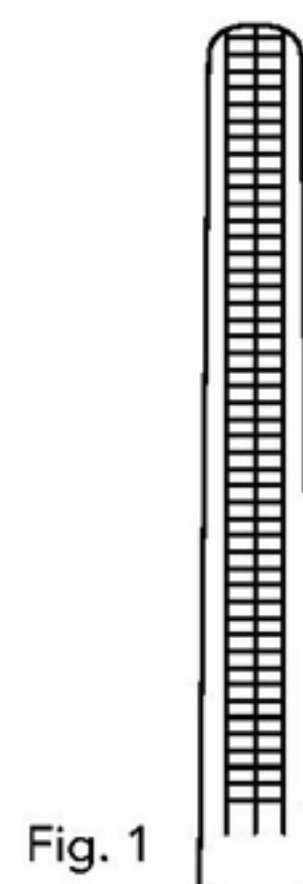

Fig. 1

GH635.10
21.5 cm/8½"

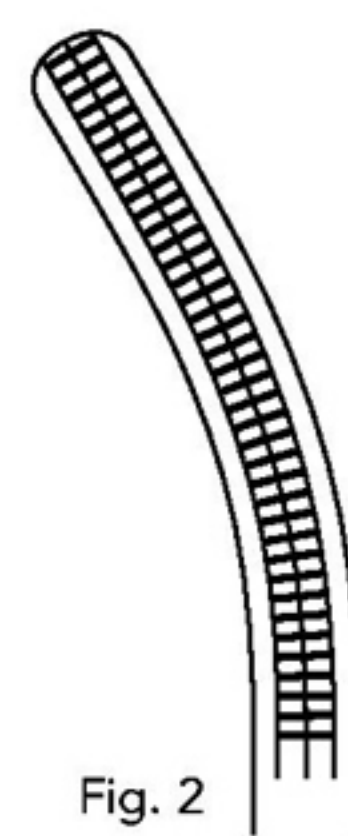

Fig. 2

GH635.20
21 cm/8¼"

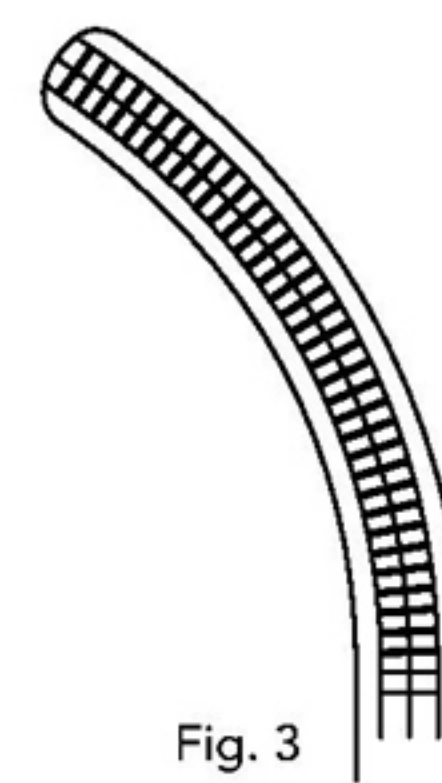

Fig. 3

GH635.30
21 cm/8¼"

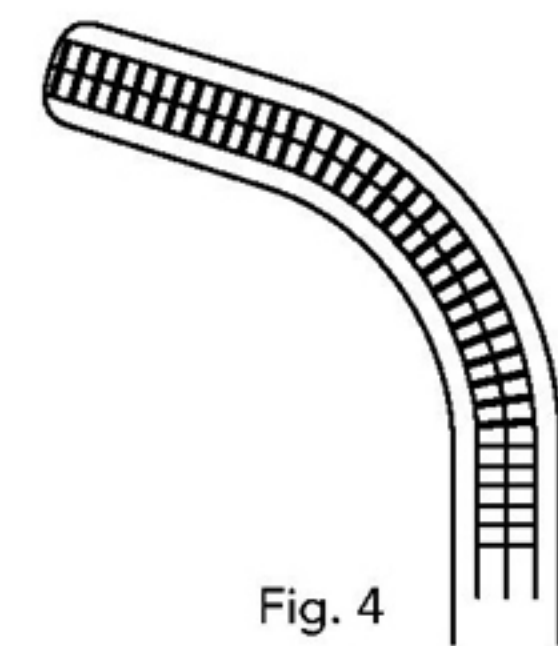

Fig. 4

GH635.40
20.5 cm/8"

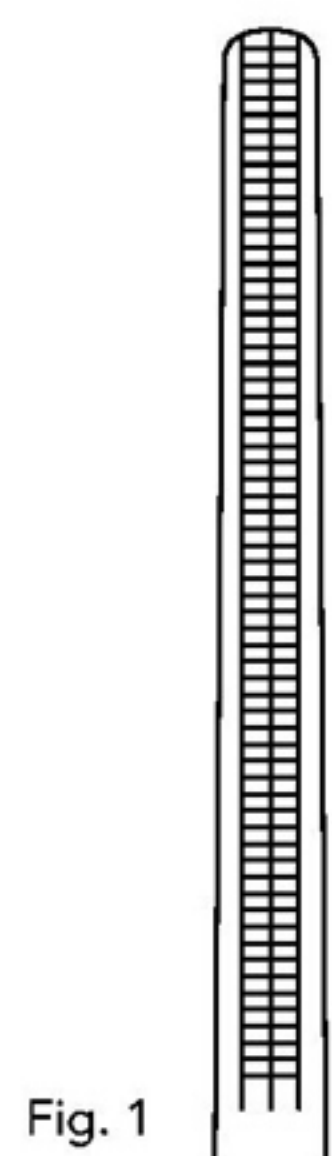

Fig. 1

GH637.10
25.5 cm/10"

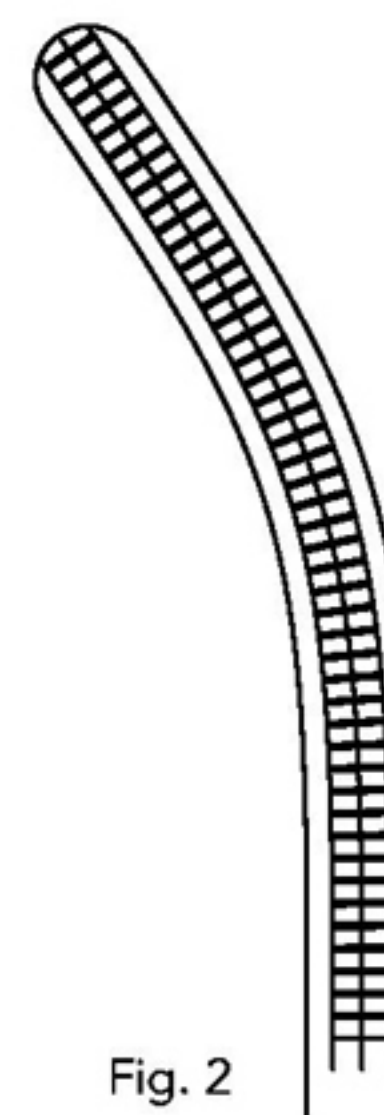

Fig. 2

GH637.20
25 cm/9¾"

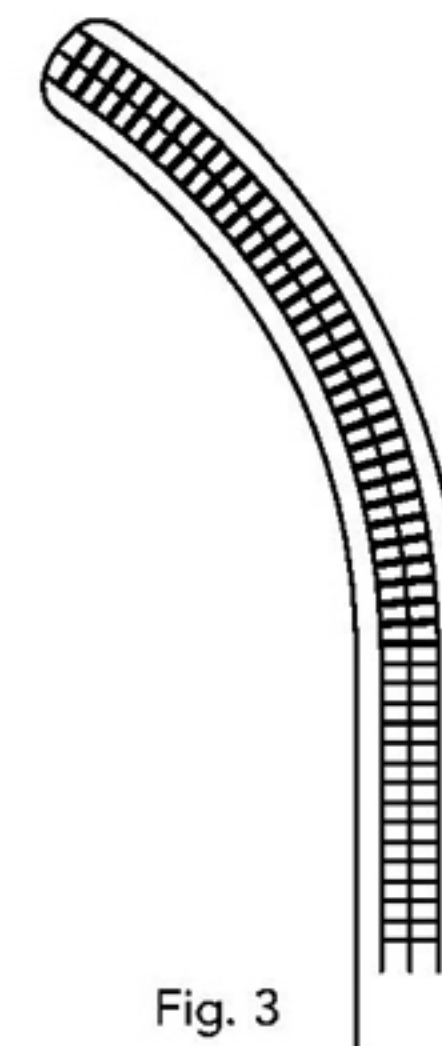

Fig. 3

GH637.30
24.5 cm/9½"

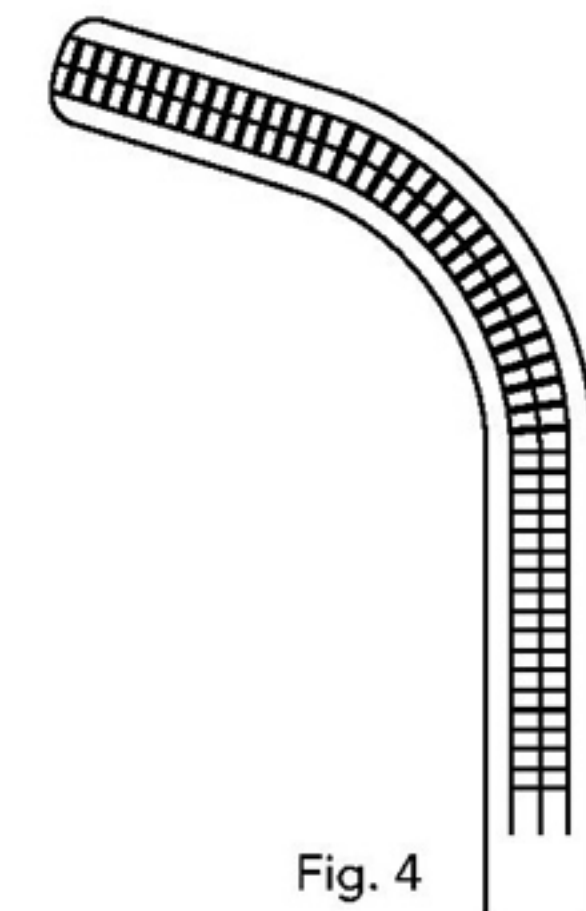
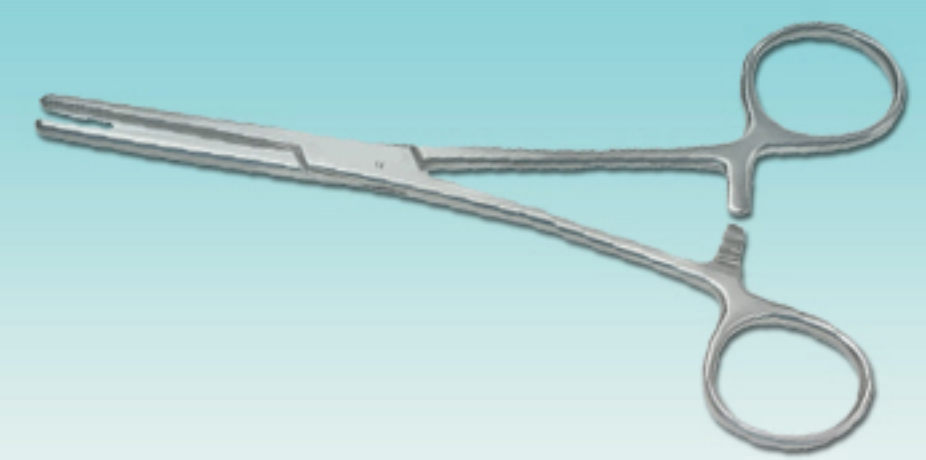

Fig. 4

GH637.40
24.5 cm/9½"



Haemostatic Forceps (Hysterectomy & Peritoneum Forceps)



WERTHEIM
GH697.25
26 cm/10¼"



WERTHEIM
GH717.22
22.5 cm/18¾"

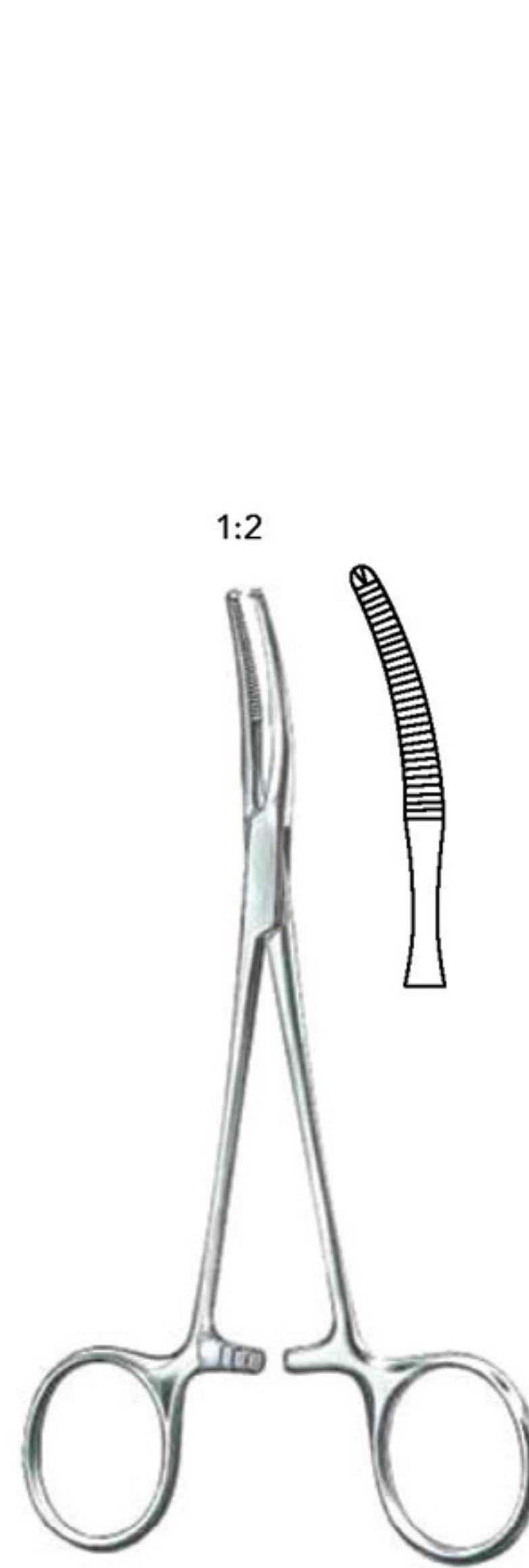

MIKULICZ-BABY
GH721.14
14.5 cm/5¾"

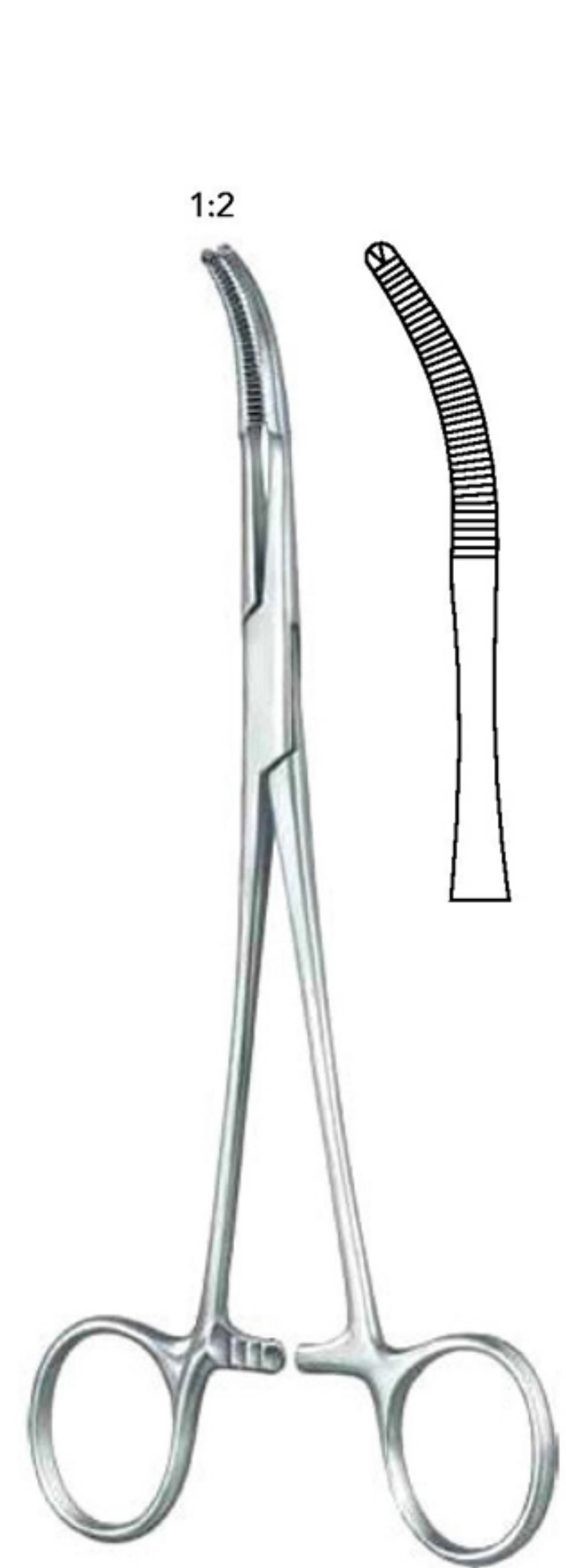

MIKULICZ
GH725.18
18.5 cm/7¼"

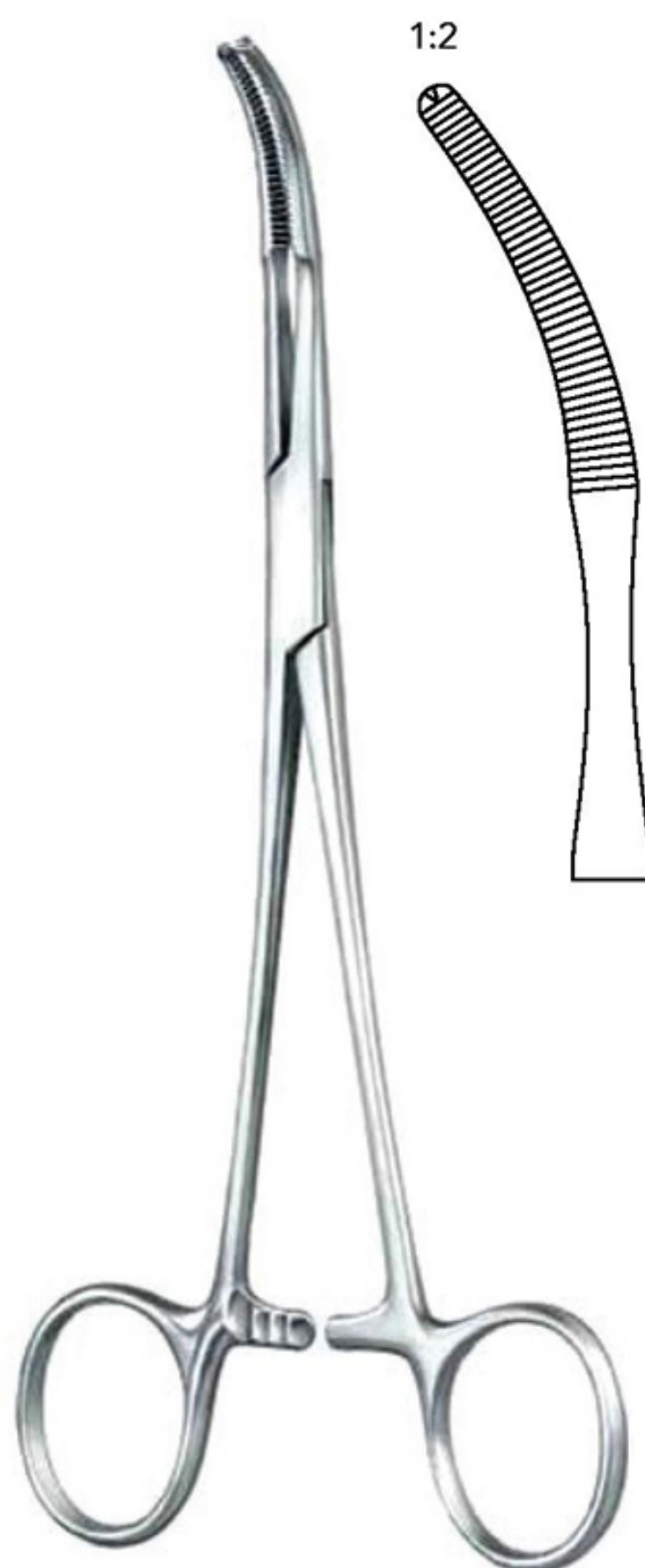

MIKULICZ
GH727.20
20 cm/8"

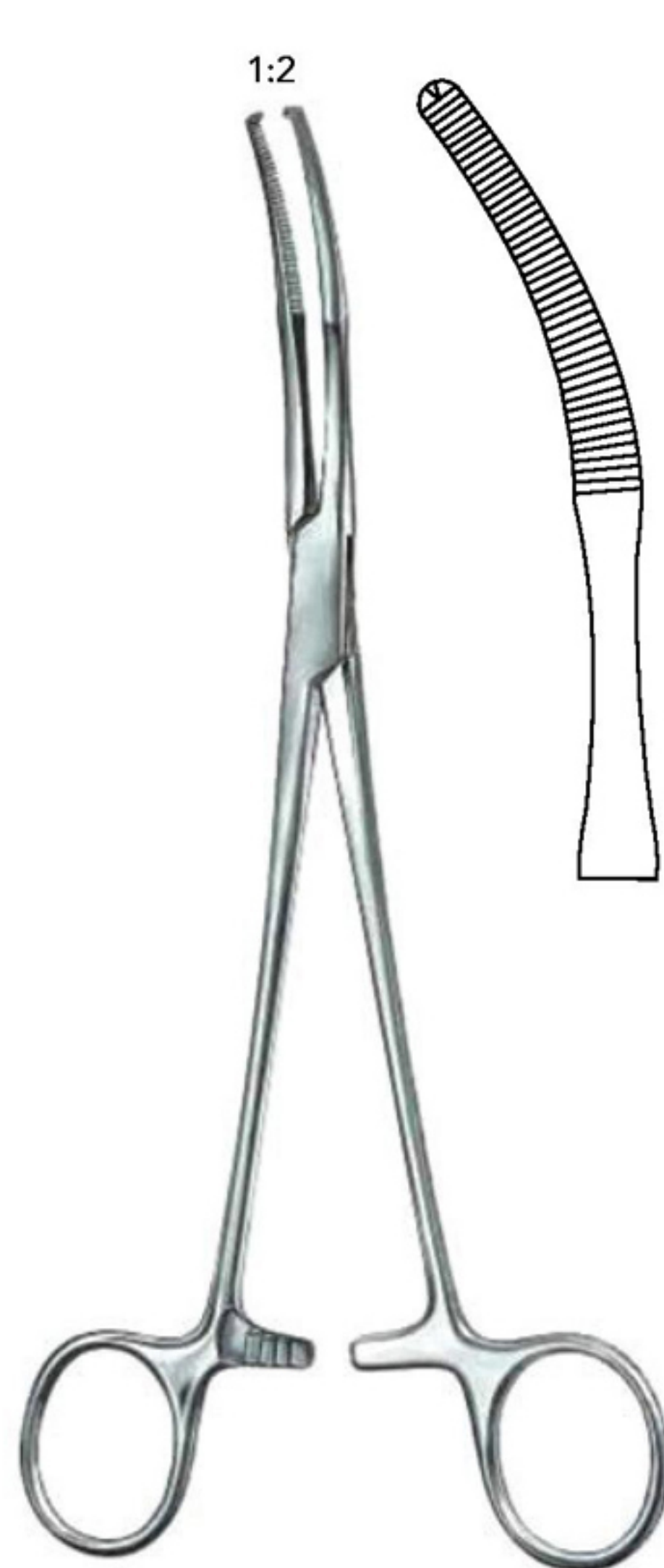

MIKULICZ
GH745.20
20 cm/8"

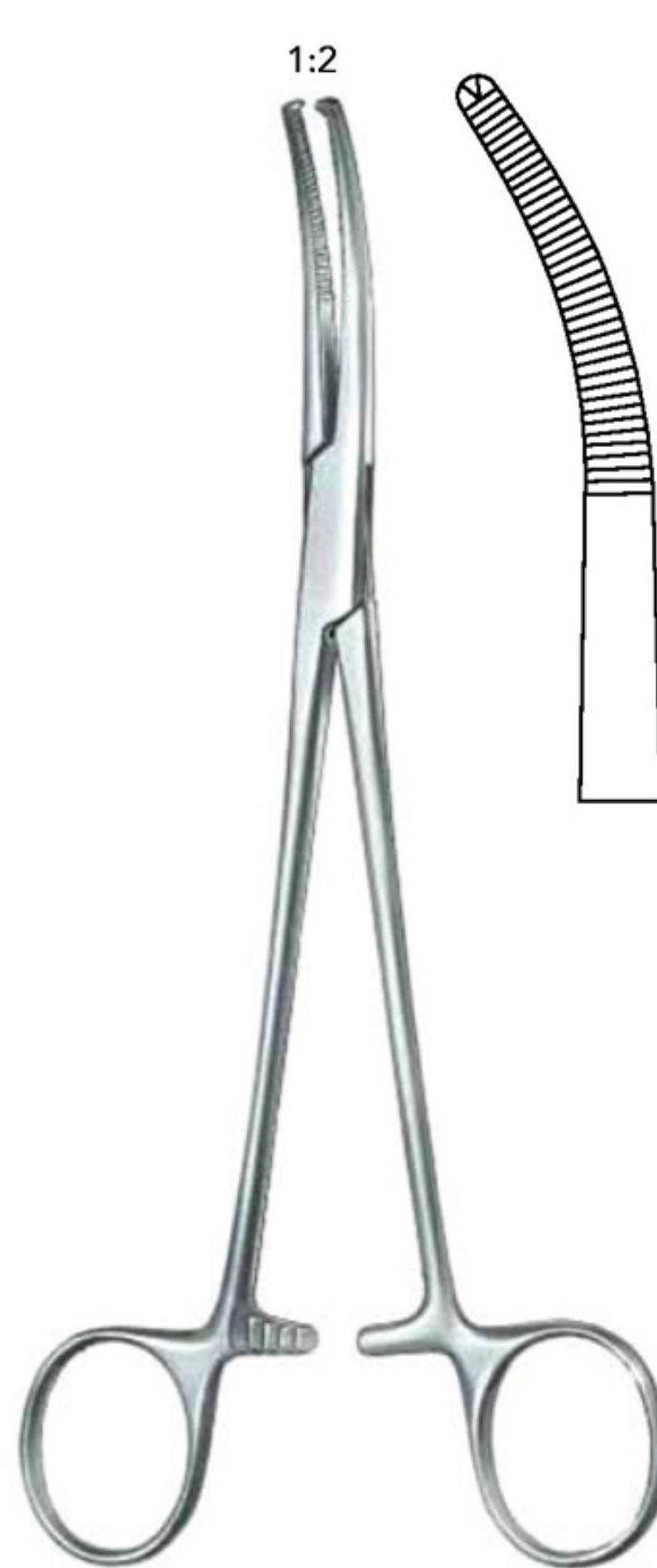

MIKULICZ
GH749.21
20.5 cm/8¼"



FAURE
GH751.20
GH753.20
21 cm/8¼"

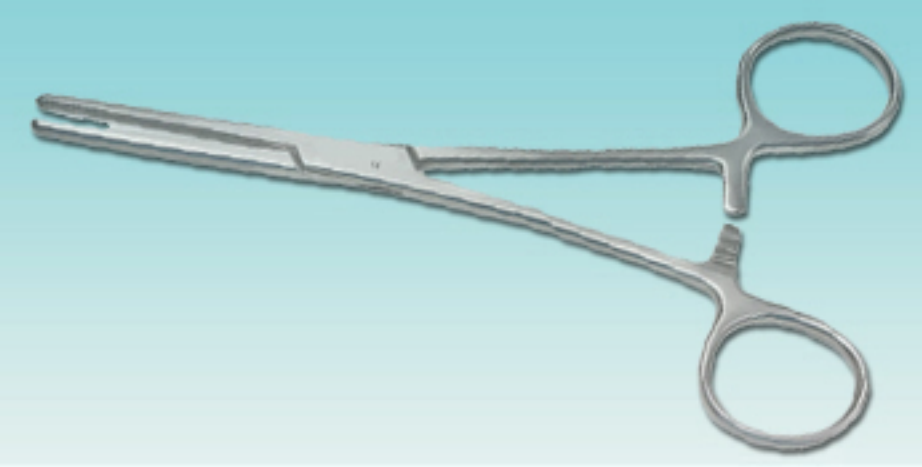

Haemostatic Forceps (Towel Clamps)

sharp



SCHAEDDEL
GH875.09
9 cm/3½"

sharp



JONES
GH881.05 5.5 cm/2¼"
GH881.09 8.5 cm/3½"

sharp



JONES
GH883.09
8.5 cm/3½"

sharp



BACKHAUS
GH915.09 9 cm/3½"
GH915.11 11 cm/4½"
GH915.13 13 cm/5¼"
GH915.15 16 cm/6¼"

sharp

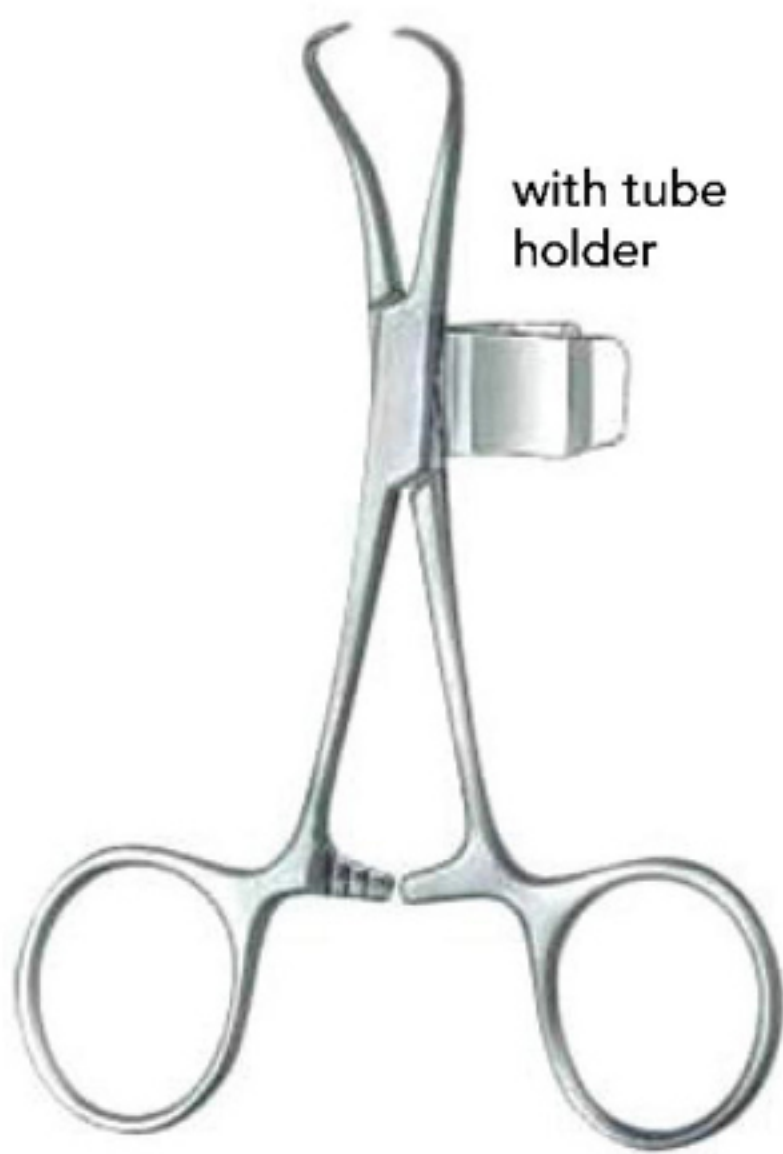

BACKHAUS
GH913.11
11 cm/4½"

delicate, sharp



BACKHAUS
GH909.11 11 cm/4½"
GH909.13 13 cm/5¼"

sharp



BERNHARD
GH921.16
16.5 cm/6½"

delicate, sharp



ROEDER
GH917.13
13.5 cm/5¼"

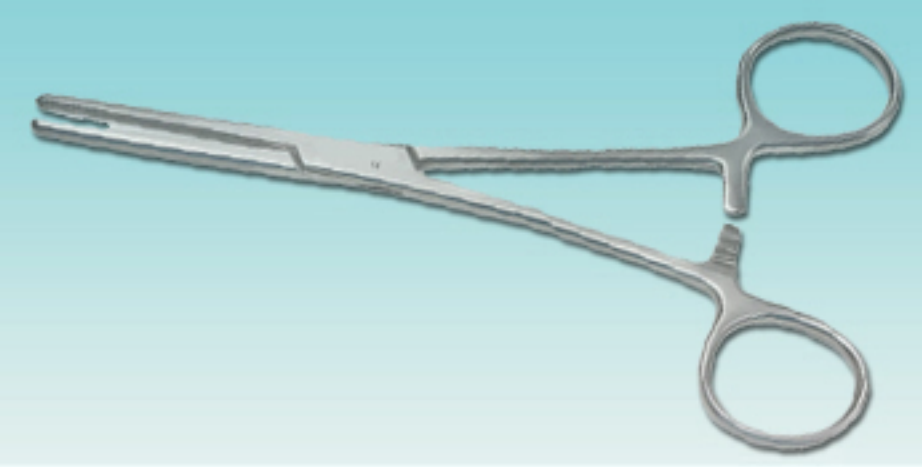

Haemostatic Forceps (Towel Clamps)

fine serration wide jaw



LORNA
GH919.10 10 cm/4"
GH919.13 13 cm/5"



JACKSON
GH1000.03
Tendon tutucu pens
Tendon seizing forcep
4 x 5 dis/4 x 5 teeth
15 cm

for paper drapes

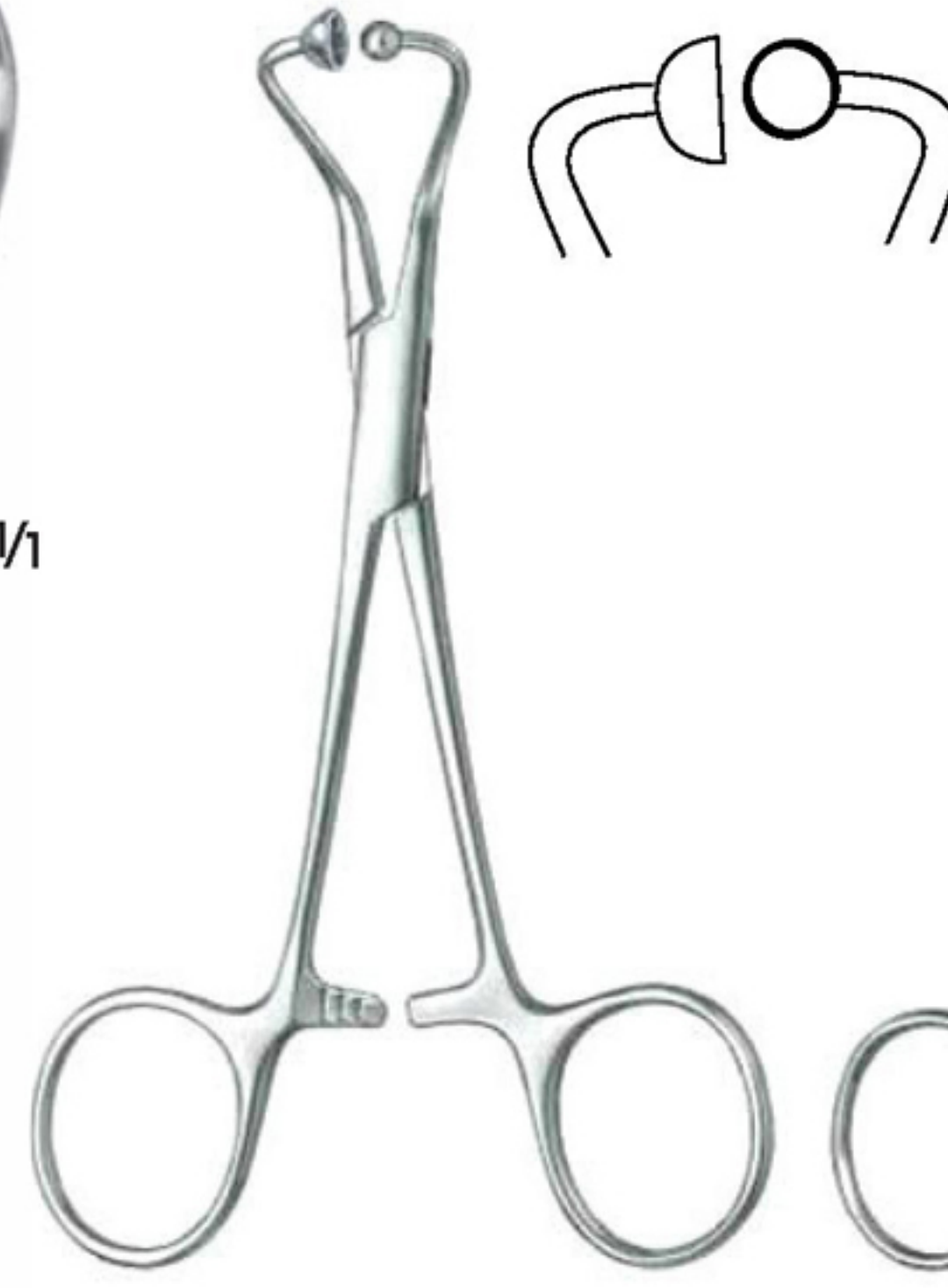

BALL & SOCKET
GH924.11 11.5 cm/4½"
GH924.14 14.0 cm/5½"

blunt

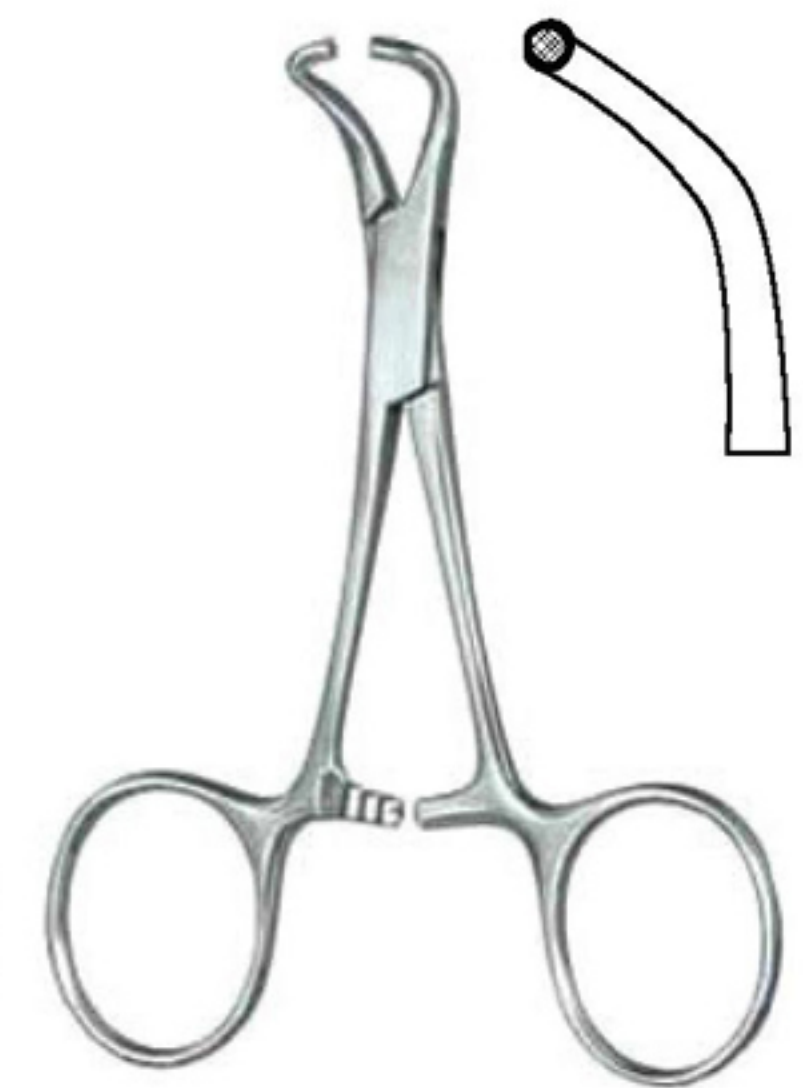

TOHOKU
GH923.10 10.5 cm/4¼"
GH923.13 13.5 cm/5¼"



PEERS-BERTRAM
GH923.14
14.5 cm/5¾"

wide jaw for tube fixation



PEERS-BERTRAM modif.
GH916.15
14.5 cm/5¾"



LANE
GH935.20
19.5 cm/7¾"

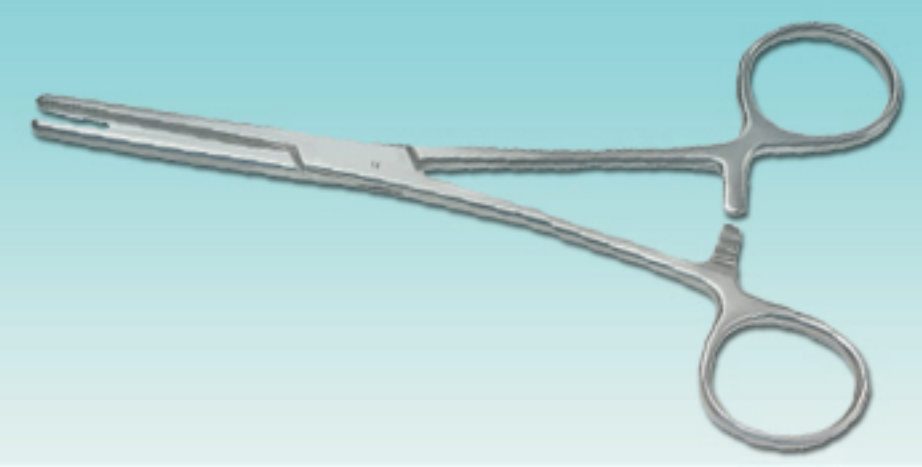

Haemostatic Forceps (Tubing Clamps)

