

## Larynx & Tonsils (Tonsil Knife, Dissectors & Gauze Packers)

serrated



**FISHER**  
**ET220.22**  
22.5 cm/9"



**BRUENINGS**  
**ET228.23**  
23 cm/9"

Tonsil knife

4.5 mm



9 mm

**CARPENTER**  
**ET269.25**  
25 cm/10"

Tonsil Dissector

11 mm



14 mm

**HURD**  
**ET281.22**  
22.5 cm/9"



**HENKE**  
24.5 cm/9¾"

serrated

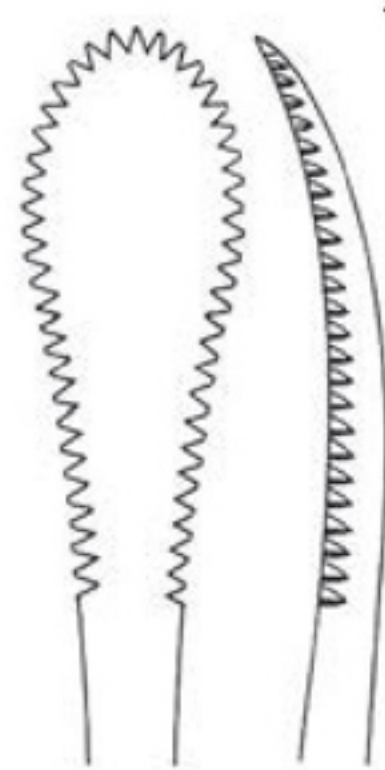

11.5 mm

**ET289.23**

5 mm

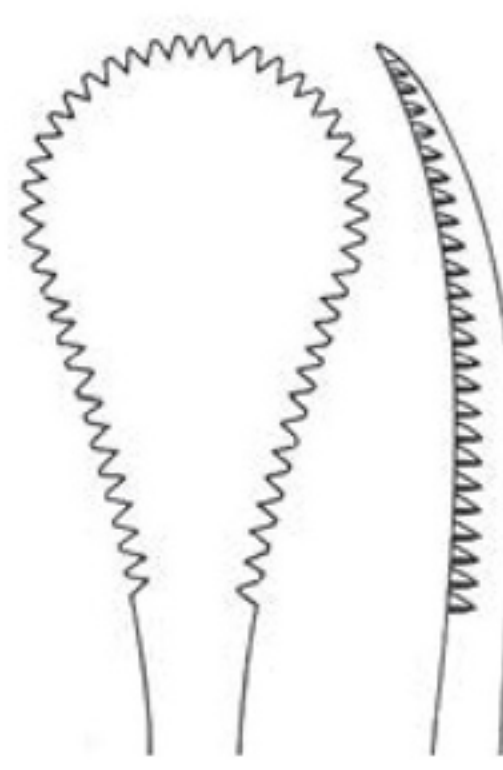

16.5 mm

**ET291.23**

5 mm



Gauze Packers



3 mm

**ET311.19**

3 mm

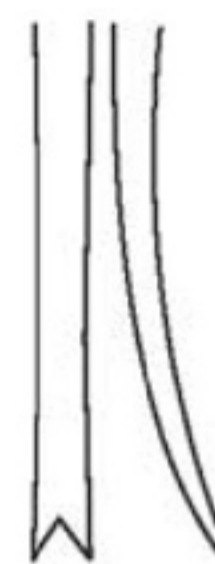

2 mm

**ET311.20**

2 mm

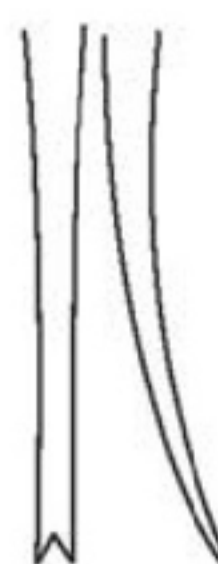

Gauze Packers



2 mm

**ET313.17**

2 mm



**LUNIATSCHEK**  
17.5 cm/7"

**LUNIATSCHEK**  
17.5 cm/7"

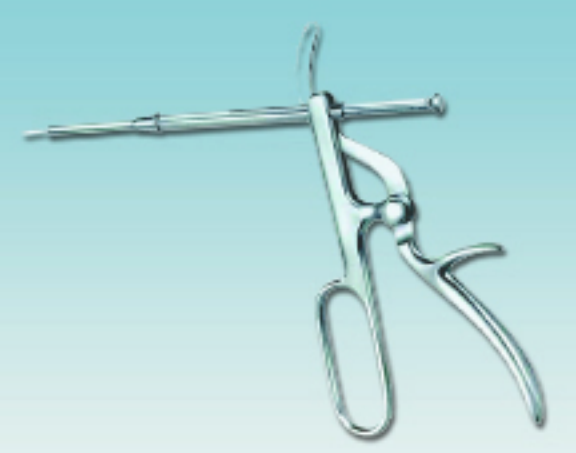

## Larynx & Tonsils (Tonsil Forceps & Tonsil Snares)

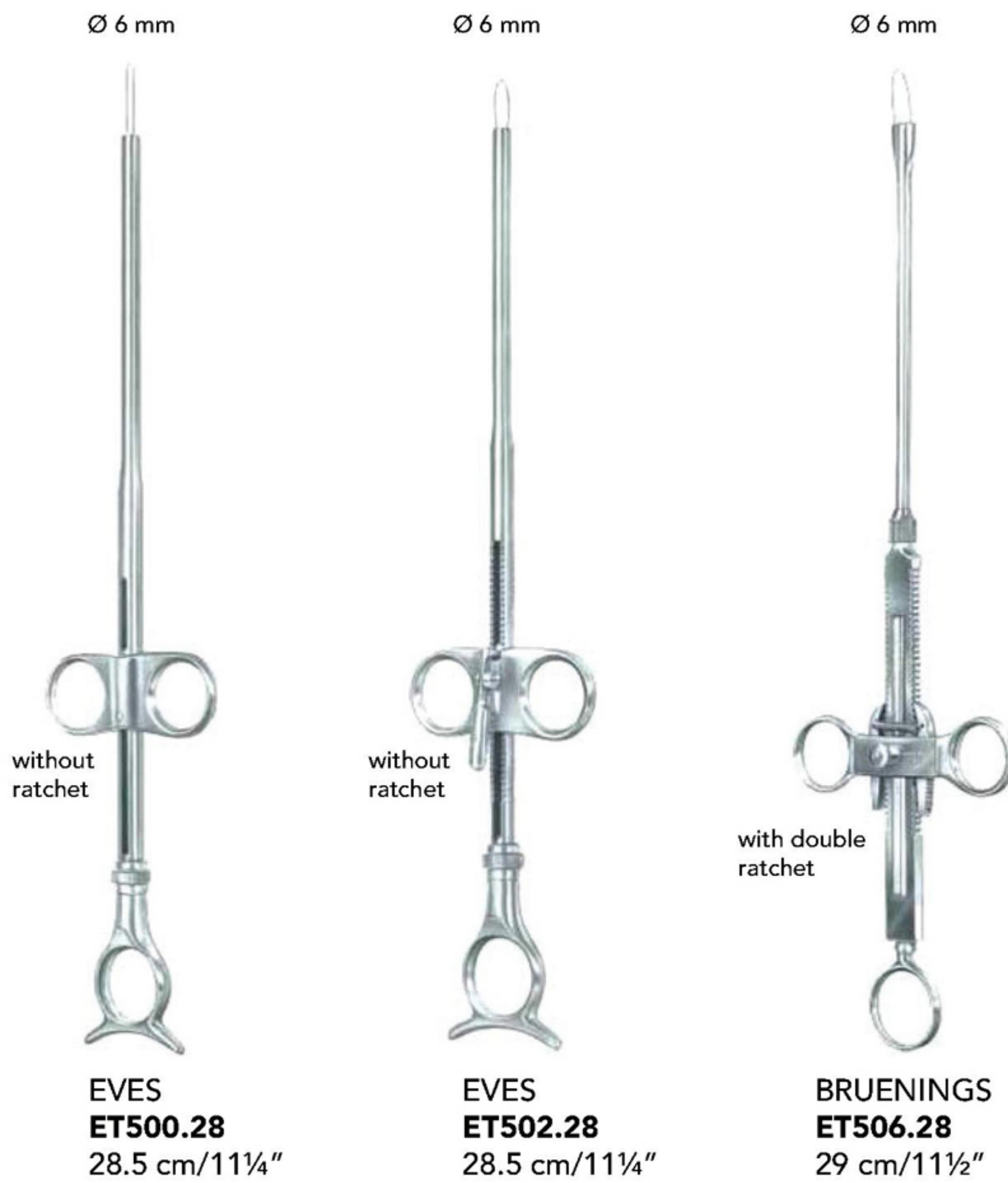
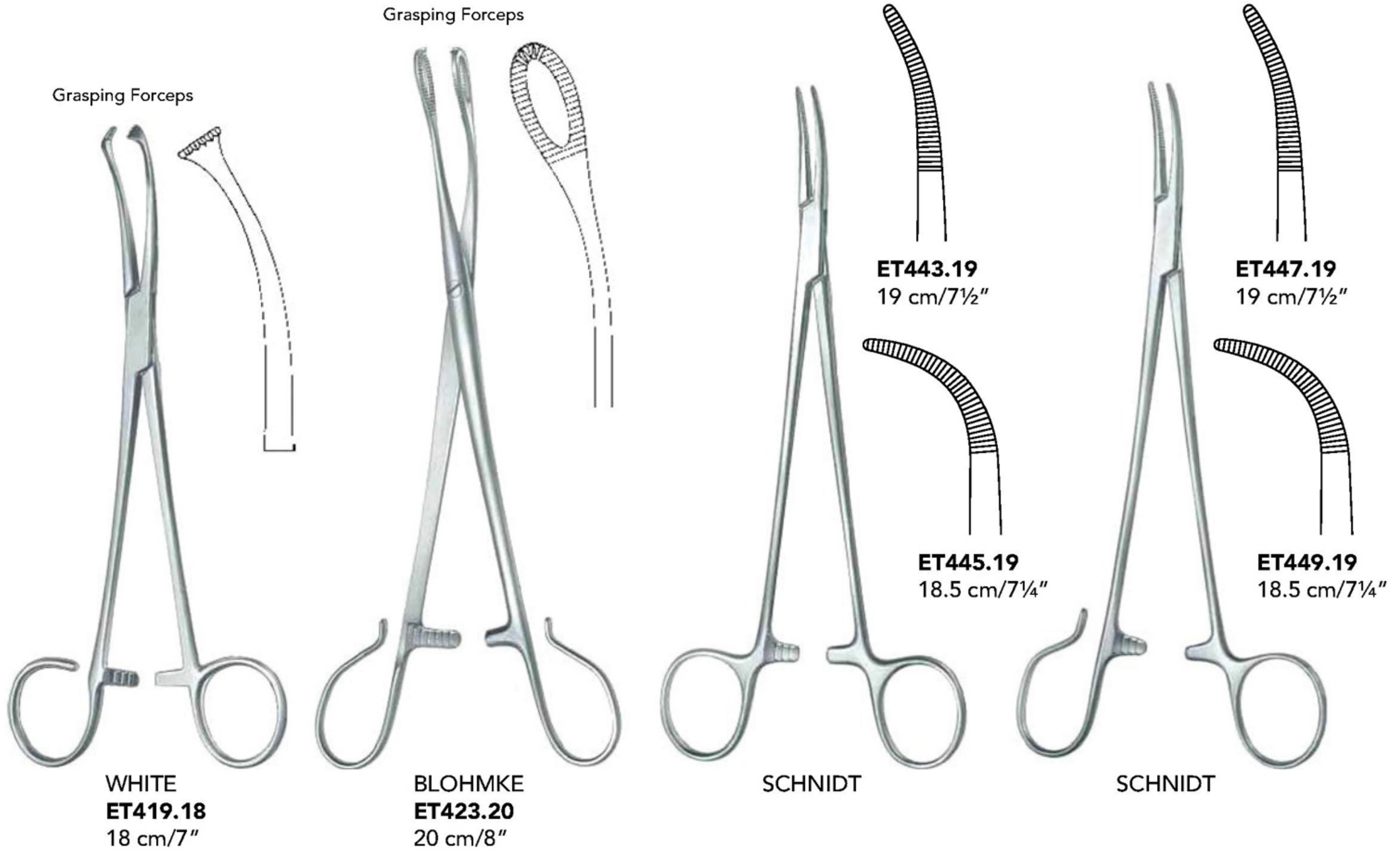

Wire Loop, package of 100 pieces

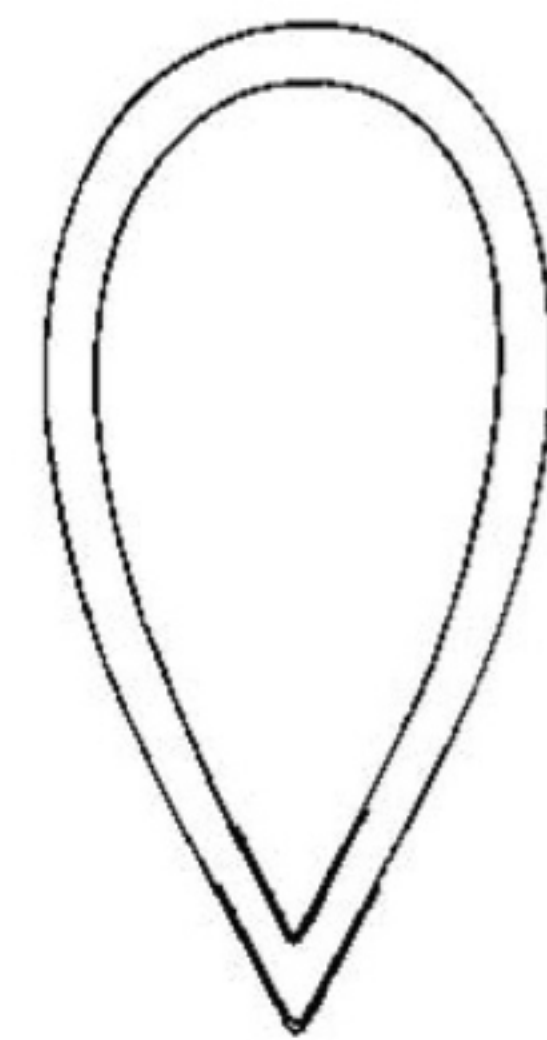

Ø 40 x 0.3 mm **ET511.40**  
Ø 50 x 0.3 mm **ET511.50**

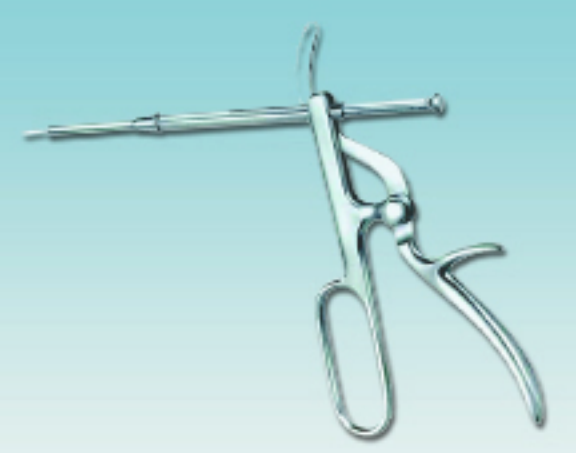

## Larynx & Tonsils (Broncho-Esophagoscopy Forceps)

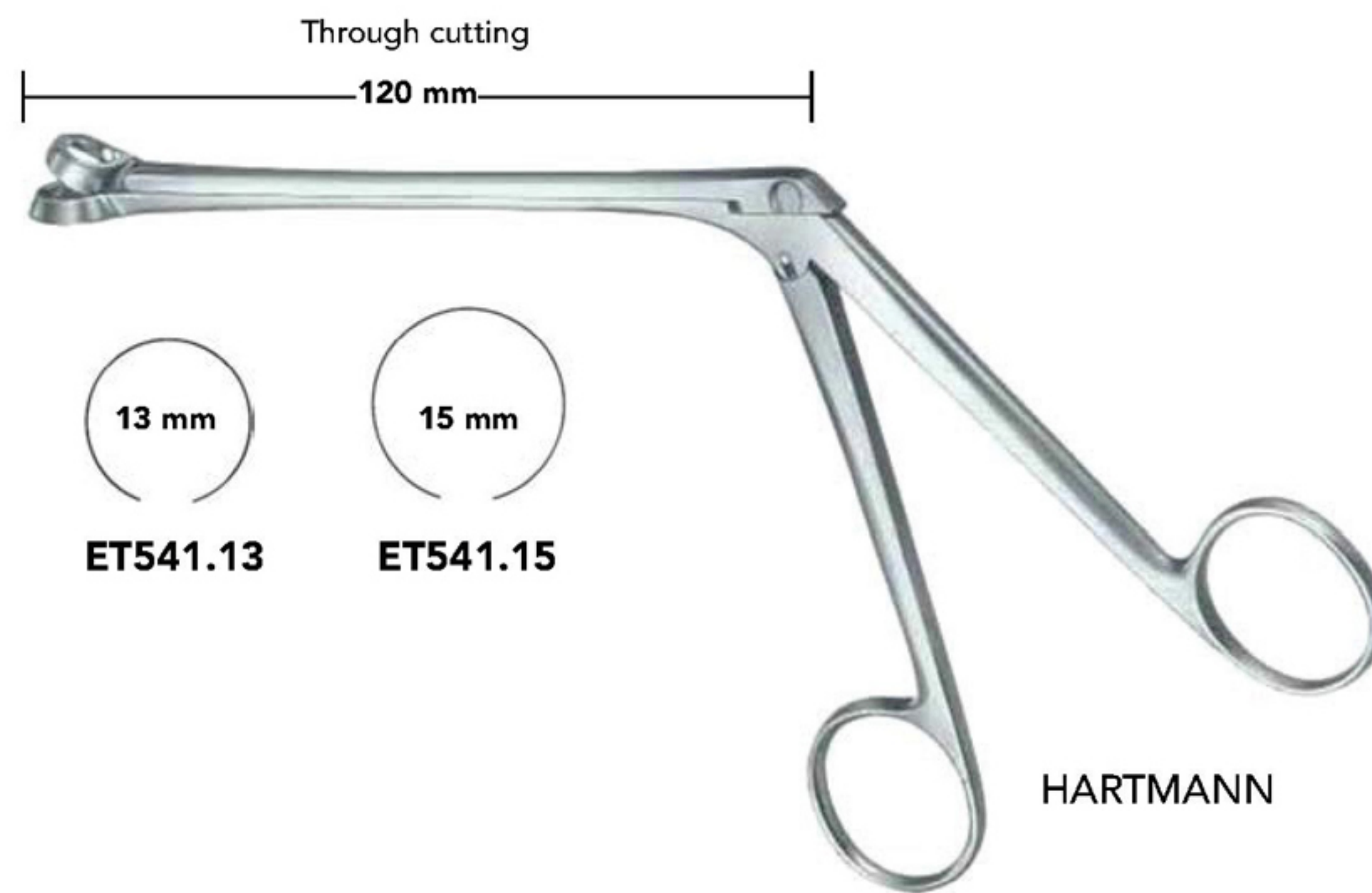
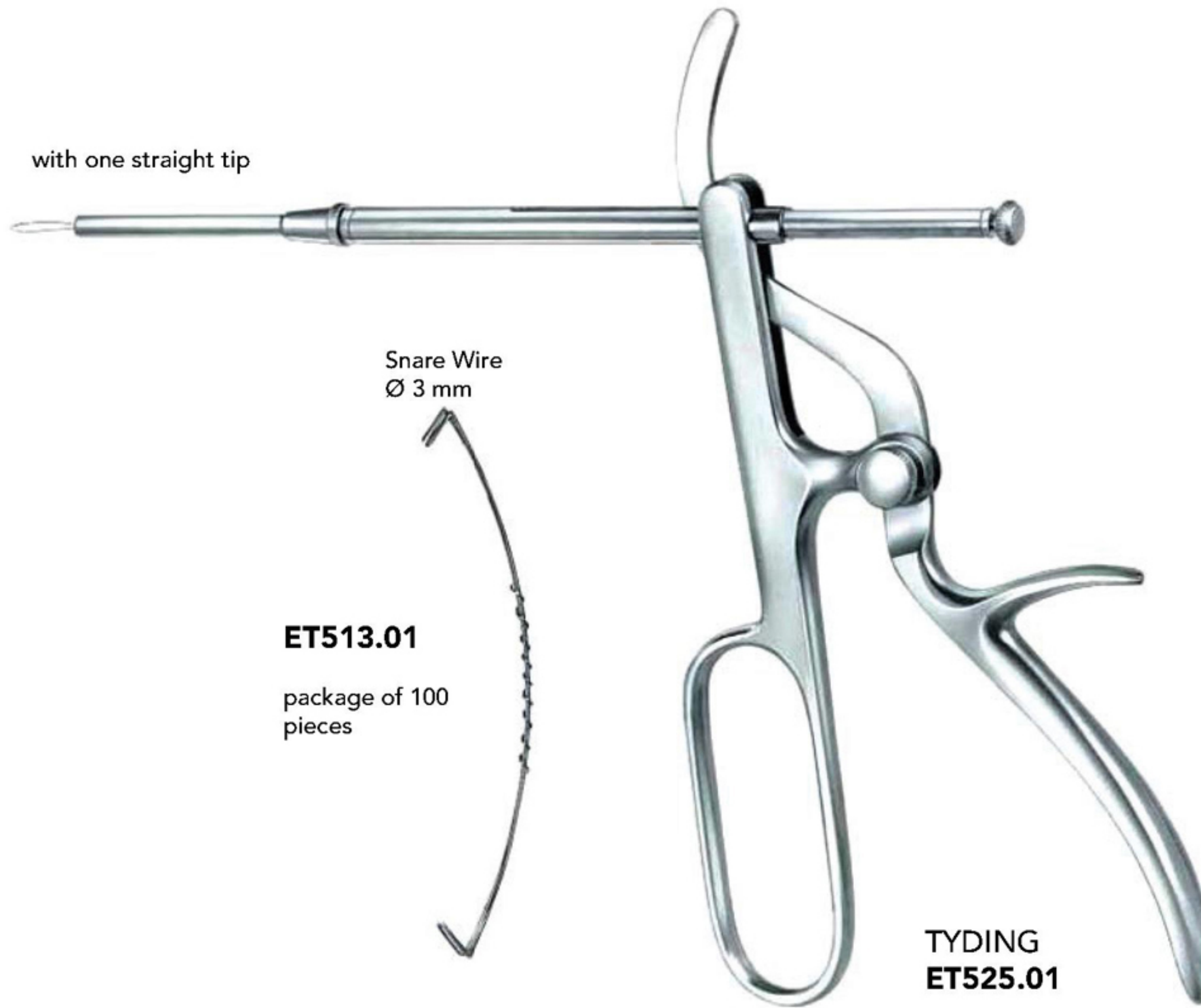

**BRÜNINGS**  
22 cm/8<sup>3</sup>/<sub>4</sub>" **ET584.20**  
32 cm/12<sup>3</sup>/<sub>4</sub>" **ET584.30**  
41 cm/16<sup>1</sup>/<sub>4</sub>" **ET584.40**



**BRÜNINGS  
ET587.20**  
18 cm/7"



**HUBER  
ET581.01**

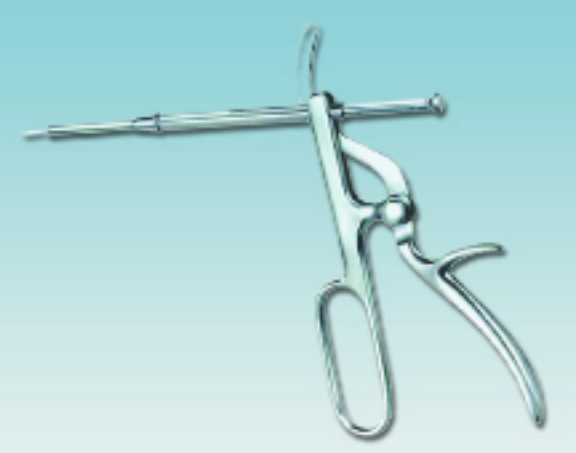

## Larynx & Tonsils (Exchangeable Tips)



**FRAENKEL  
ET600.01**



**SEIFFERT  
ET604.01**



**FRAENKEL  
ET608.01**



**SCHEINMANN  
ET611.01**



**SCHEINMANN  
ET613.01**



**BRUENINGS  
Fig. 2 ET616.02  
Fig. 3 ET616.03**



**BRUENINGS  
Fig. 2 ET618.02  
Fig. 3 ET618.03**



**LANGE  
ET624.01**



**KRAUSE  
Fig. 1 ET628.01  
Fig. 2 ET628.02**



**KRAUSE  
ET632.01**



**CORDES  
Fig. 1 ET637.01  
Fig. 2 ET637.02  
Fig. 3 ET637.03  
Fig. 4 ET637.04**



**SCHUMACHER  
ET639.01**



**CORDES  
Fig. 1 ET643.01  
Fig. 2 ET643.02**



**CORDES  
ET647.01**



**ROSENBERG  
ET657.01**

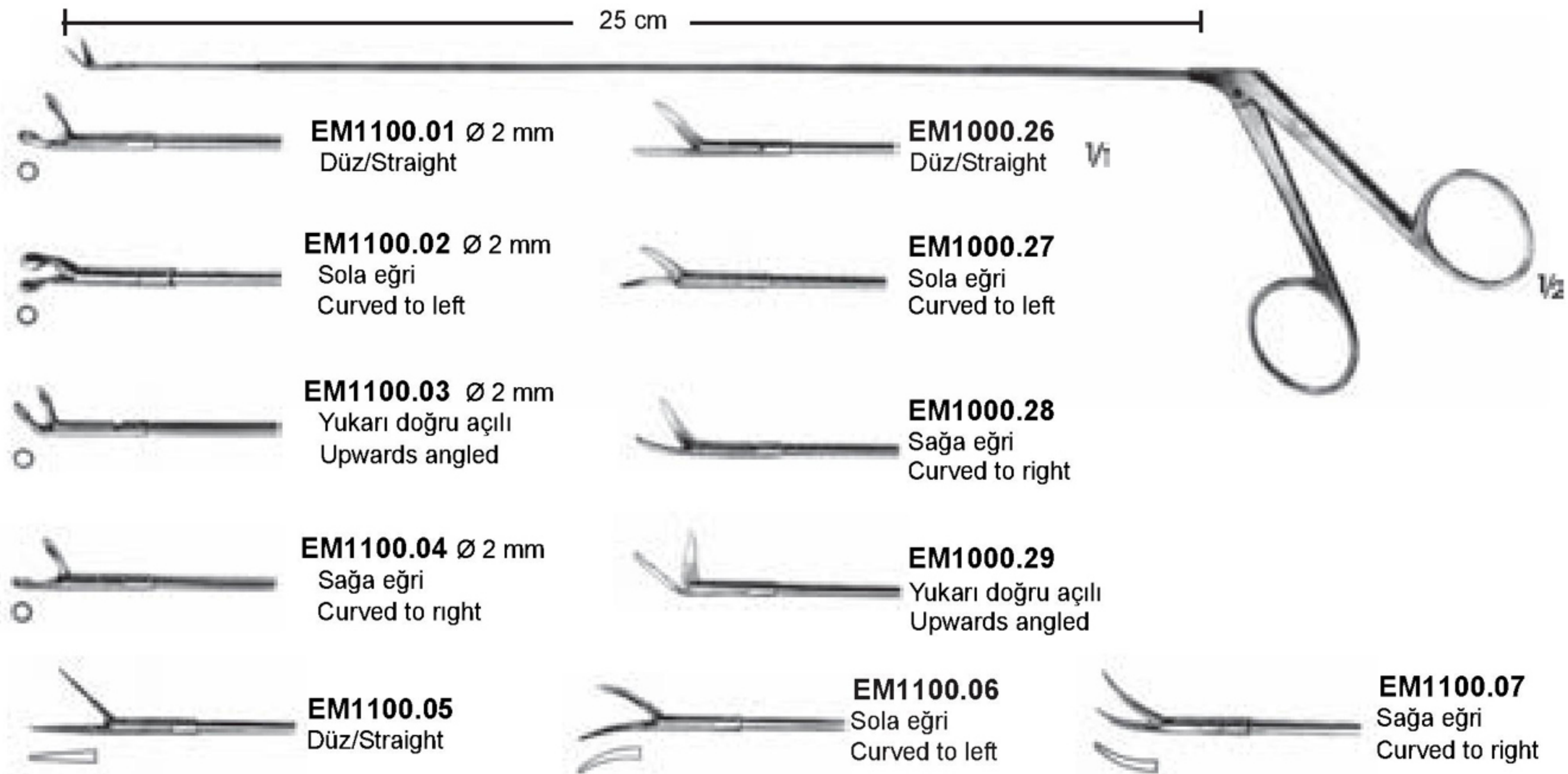



## Larynx & Tonsils (Laryngeal Mirrors)



MICHEL  
27 cm/7½"

Fig.		
1	Ø 12 mm	<b>ET789.12</b>
2	Ø 14 mm	<b>ET789.14</b>
3	Ø 16 mm	<b>ET789.16</b>
4	Ø 18 mm	<b>ET789.18</b>



**ET794.11**  
11 cm/4¼"



**ET798.12**  
12.5 cm/5"

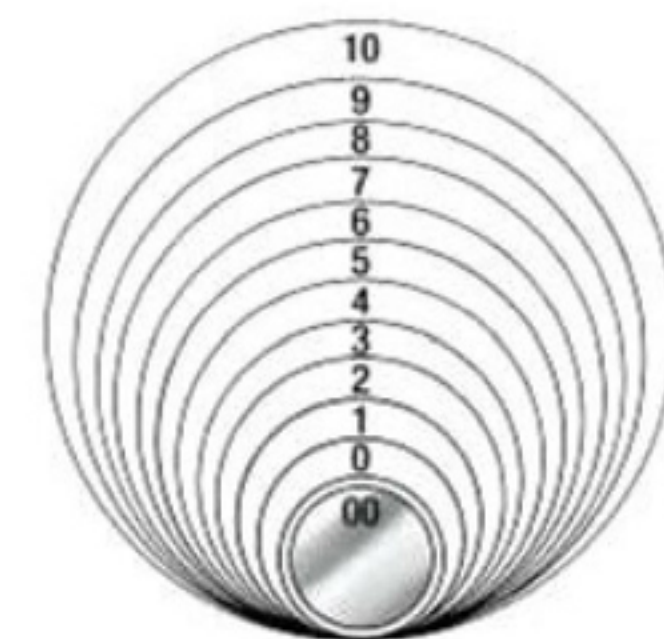
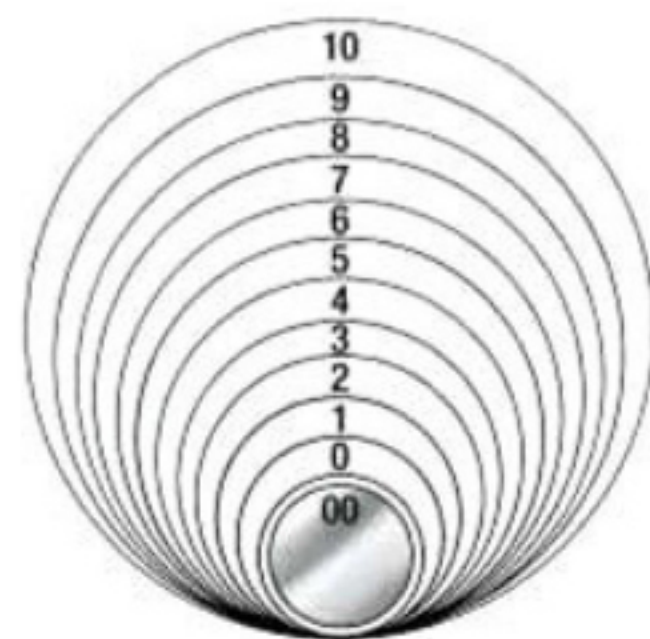

plane, with fixed handle



18.5 cm/7¼"

Fig. 00	Ø 8 mm	<b>ET781.08</b>
Fig. 0	Ø 10 mm	<b>ET781.10</b>
Fig. 1	Ø 12 mm	<b>ET781.12</b>
Fig. 2	Ø 14 mm	<b>ET781.14</b>
Fig. 3	Ø 16 mm	<b>ET781.16</b>
Fig. 4	Ø 18 mm	<b>ET781.18</b>
Fig. 5	Ø 20 mm	<b>ET781.20</b>
Fig. 6	Ø 22 mm	<b>ET781.22</b>
Fig. 7	Ø 24 mm	<b>ET781.24</b>
Fig. 8	Ø 26 mm	<b>ET781.26</b>
Fig. 9	Ø 28 mm	<b>ET781.28</b>
Fig. 10	Ø 30 mm	<b>ET781.30</b>

### RHODIUM

Fig. 00	Ø 8 mm	<b>ET782.08</b>
Fig. 0	Ø 10 mm	<b>ET782.10</b>
Fig. 1	Ø 12 mm	<b>ET782.12</b>
Fig. 2	Ø 14 mm	<b>ET782.14</b>
Fig. 3	Ø 16 mm	<b>ET782.16</b>
Fig. 4	Ø 18 mm	<b>ET782.18</b>
Fig. 5	Ø 20 mm	<b>ET782.20</b>
Fig. 6	Ø 22 mm	<b>ET782.22</b>
Fig. 7	Ø 24 mm	<b>ET782.24</b>
Fig. 8	Ø 26 mm	<b>ET782.26</b>
Fig. 9	Ø 28 mm	<b>ET782.28</b>
Fig. 10	Ø 30 mm	<b>ET782.30</b>

plane, without handle



13.5 cm/5¼"

Fig. 00	Ø 8 mm	<b>ET785.08</b>
Fig. 0	Ø 10 mm	<b>ET785.10</b>
Fig. 1	Ø 12 mm	<b>ET785.12</b>
Fig. 2	Ø 14 mm	<b>ET785.14</b>
Fig. 3	Ø 16 mm	<b>ET785.16</b>
Fig. 4	Ø 18 mm	<b>ET785.18</b>
Fig. 5	Ø 20 mm	<b>ET785.20</b>
Fig. 6	Ø 22 mm	<b>ET785.22</b>
Fig. 7	Ø 24 mm	<b>ET785.24</b>
Fig. 8	Ø 26 mm	<b>ET785.26</b>
Fig. 9	Ø 28 mm	<b>ET785.28</b>
Fig. 10	Ø 30 mm	<b>ET785.30</b>

### RHODIUM

Fig. 00	Ø 8 mm	<b>ET786.08</b>
Fig. 0	Ø 10 mm	<b>ET786.10</b>
Fig. 1	Ø 12 mm	<b>ET786.12</b>
Fig. 2	Ø 14 mm	<b>ET786.14</b>
Fig. 3	Ø 16 mm	<b>ET786.16</b>
Fig. 4	Ø 18 mm	<b>ET786.18</b>
Fig. 5	Ø 20 mm	<b>ET786.20</b>
Fig. 6	Ø 22 mm	<b>ET786.22</b>
Fig. 7	Ø 24 mm	<b>ET786.24</b>
Fig. 8	Ø 26 mm	<b>ET786.26</b>
Fig. 9	Ø 28 mm	<b>ET786.28</b>
Fig. 10	Ø 30 mm	<b>ET786.30</b>

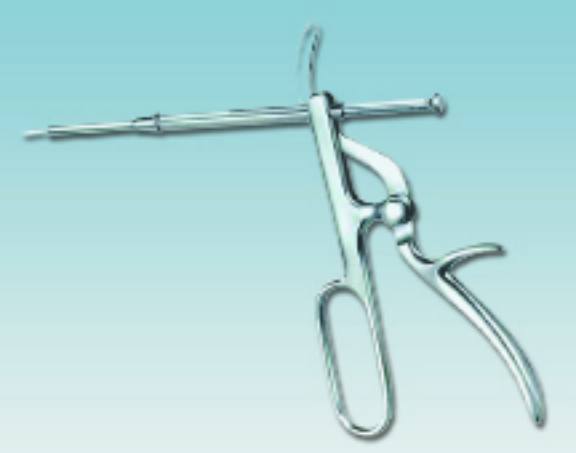

## Larynx & Tonsils (Laryngeal Polypus Forceps)

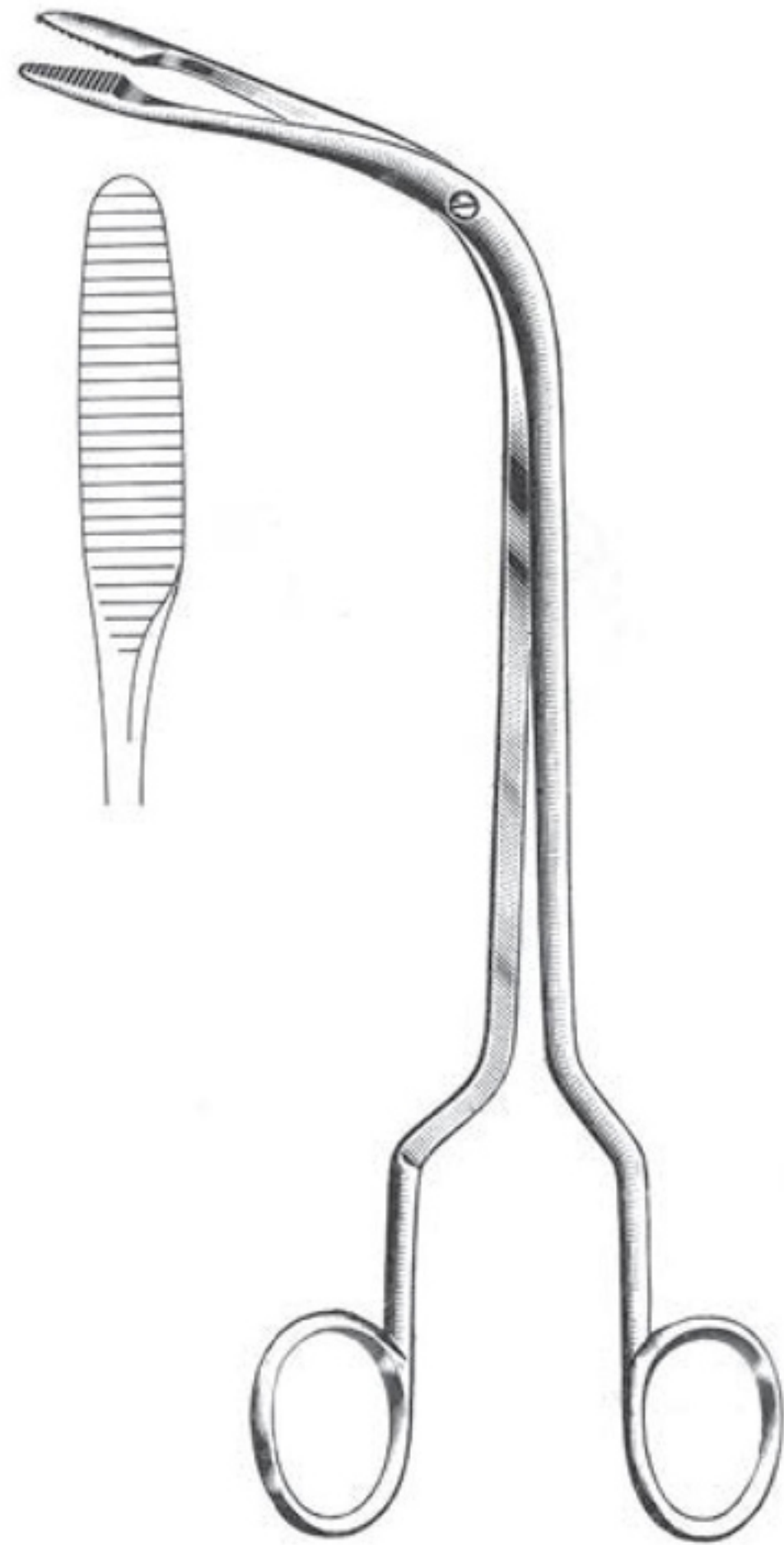

**FRAENKEL**  
**ET805.19**  
18 cm/7"



**ET814.01**  
Fig. 1

**ET814.02**  
Fig. 2

**ET814.03**  
Fig. 3

**ET814.04**  
Fig. 4



**JURASZ**  
23 cm/9"

Tampon forceps

with spike



**ET821.21**

without spike



**ET821.22**

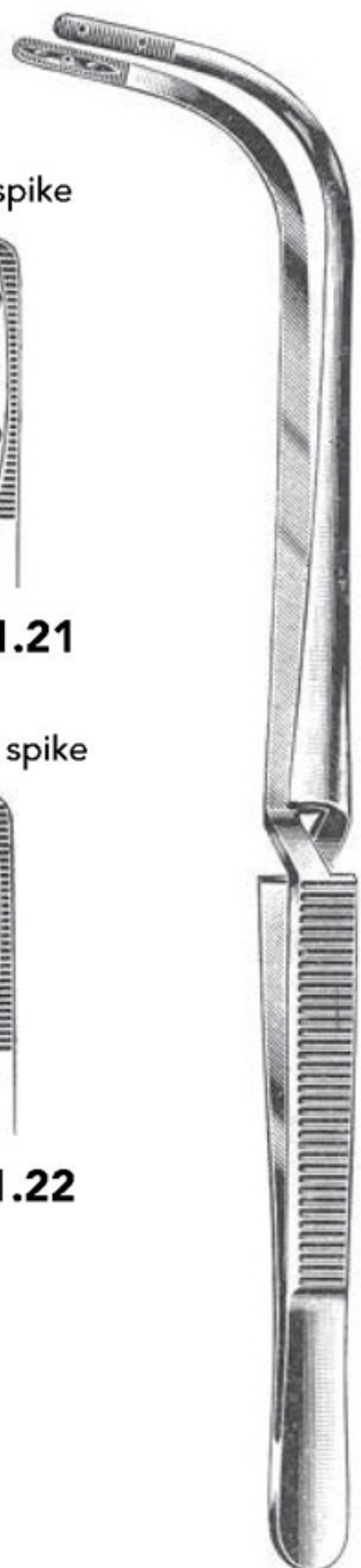

**JACKSON**  
22 cm/8¾"

Epiglottis Retractor

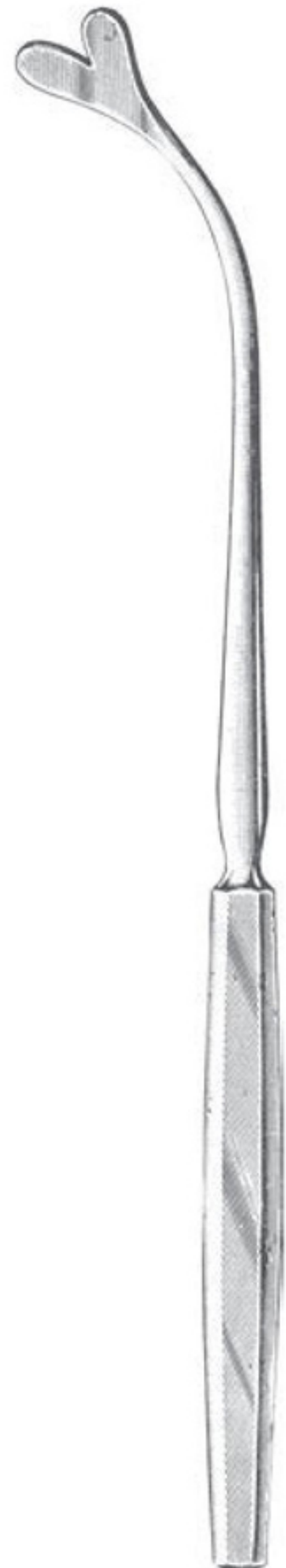

**REICHERT**  
**ET831.24**  
24 cm/9½"

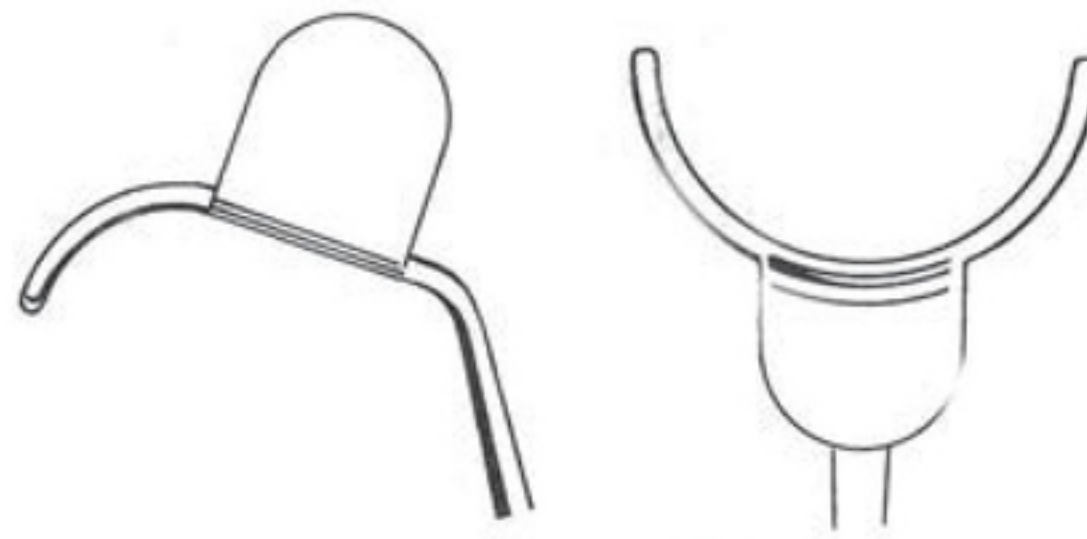

Tonsillectomy  
Retractor

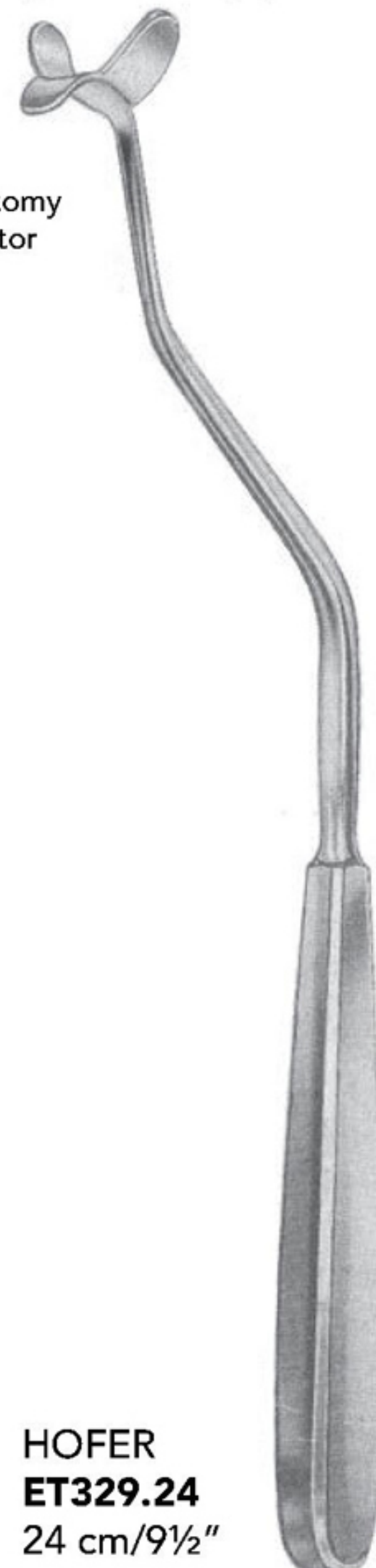

**HOFER**  
**ET329.24**  
24 cm/9½"



Soft Plate  
Retractor



**NAGER**  
**ET331.23**  
24 cm/9"

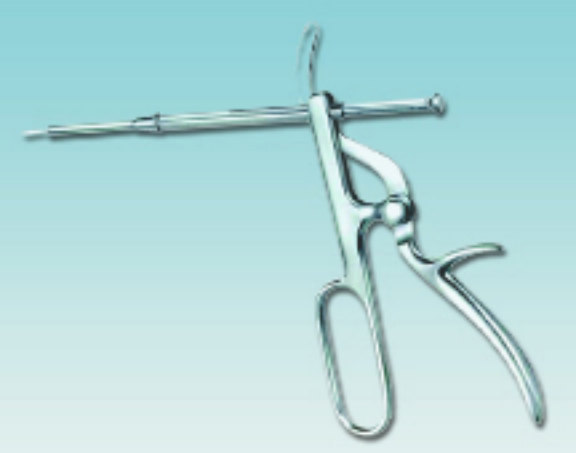

## Larynx & Tonsils (Mouthgags & Tongue Depressors)

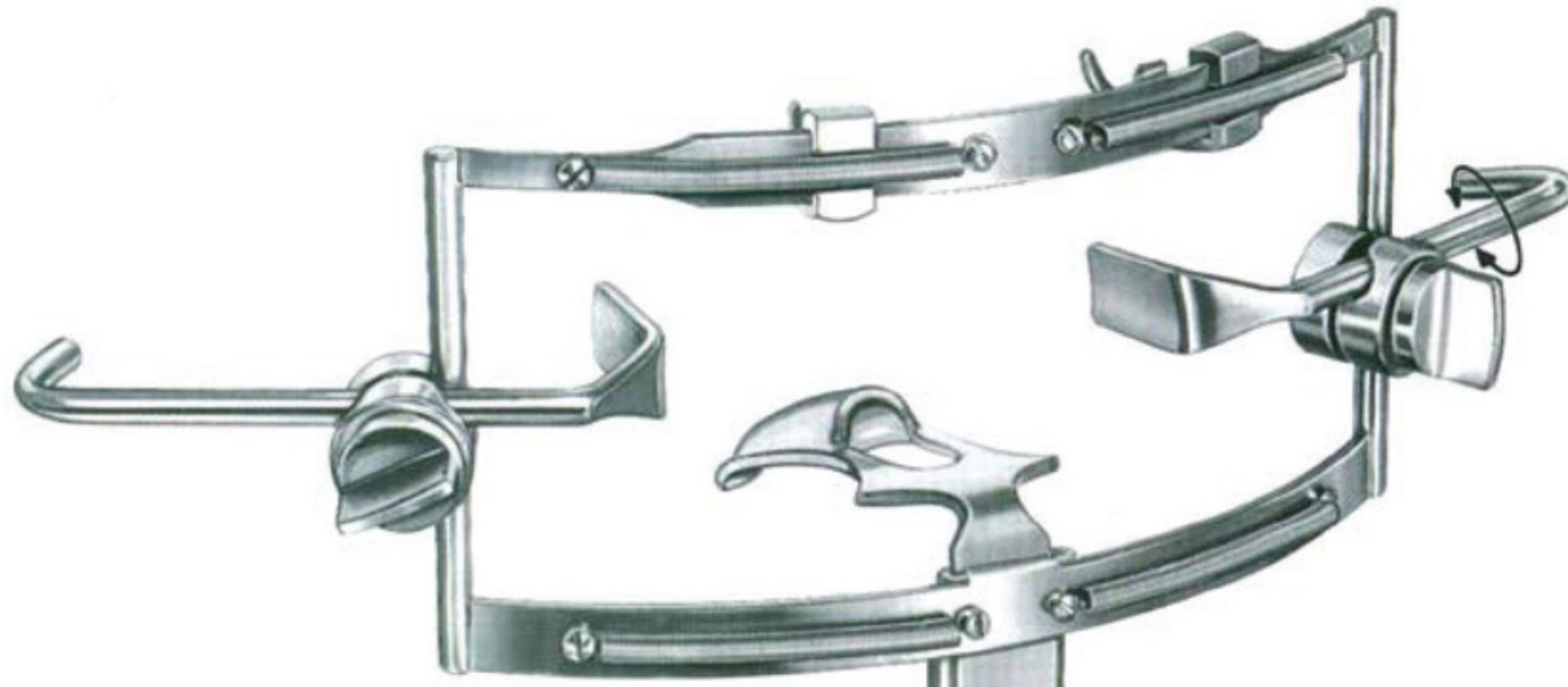

**EM224.00**  
Complete set

**EM1000.06**  
Mouth gag only



Fig. 1

McIVOR  
**EM222.00**  
Complete set



Fig. 1

Fig. 3

**EM224.01**

**EM224.02**

**EM224.03**

DINGMANN



Fig. 2

Fig. 3

**EM222.01**

**EM222.02**

**EM222.03**

Tongue depressors

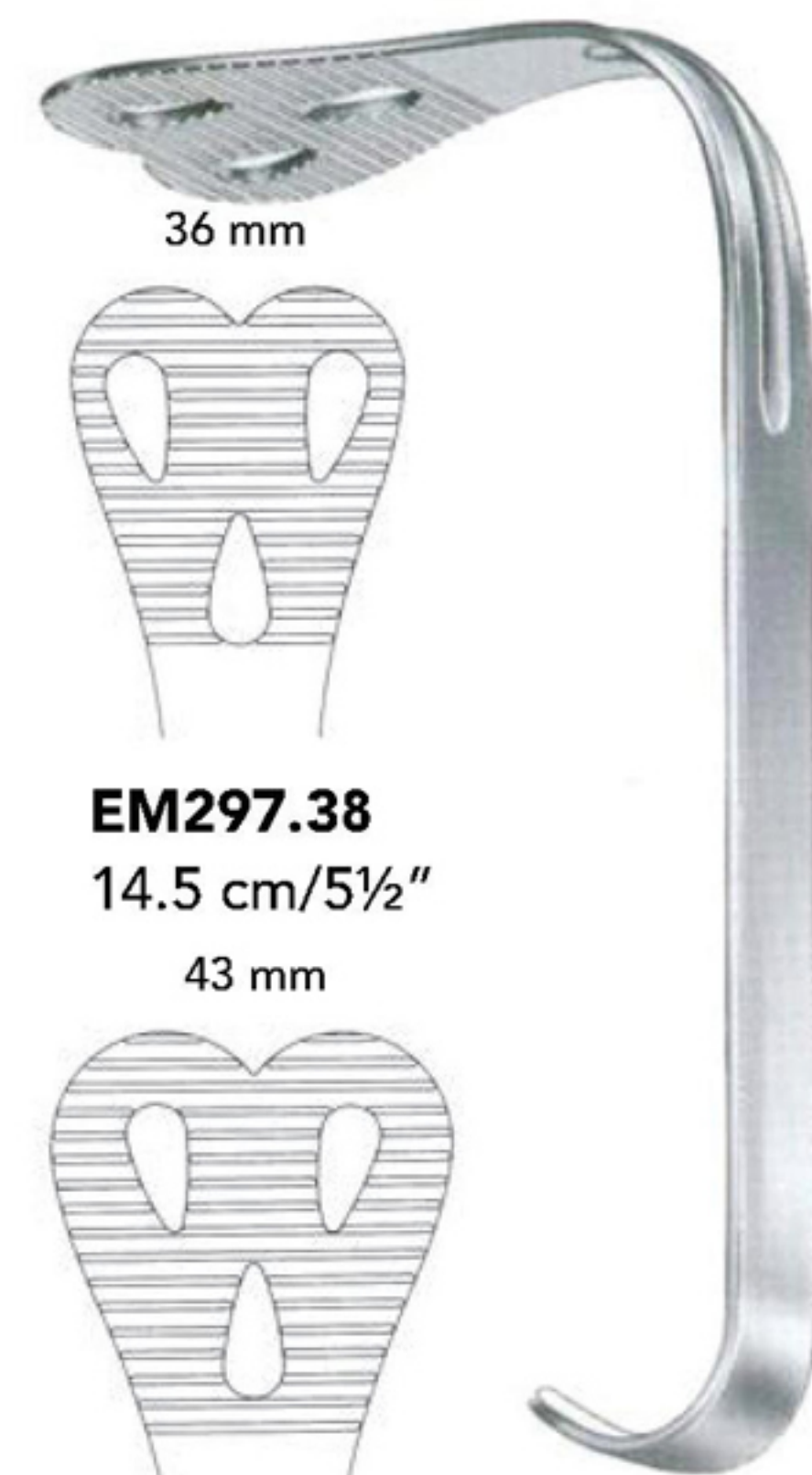

36 mm

**EM297.38**

14.5 cm/5½"

43 mm

**EM297.45**

15 cm/6"

WIEDER

### JENNINGS

- 9.0 cm/3½" **EM237.09**
- 11 cm/4½" **EM237.11**
- 13.0 cm/5" **EM237.13**
- 15.0 cm/6" **EM237.15**



### WHITEHEAD

- 9.0 cm/3½" **EM1000.36**
- 11 cm/4½" **EM1000.37**
- 13.0 cm/5" **EM1000.38**
- 15.0 cm/6" **EM1000.39**

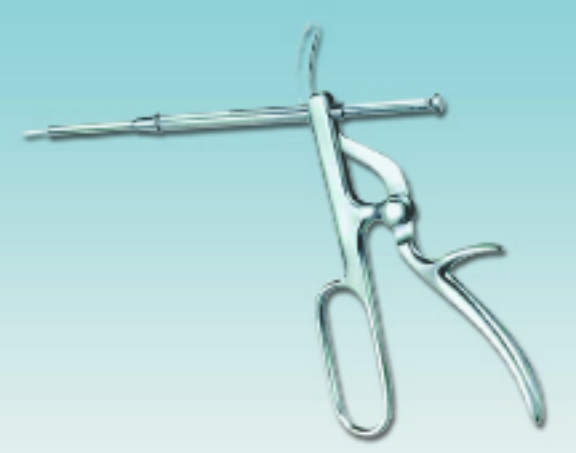

## Larynx & Tonsils (Mouthgags & Tongue Spatulas)



$\frac{1}{2}$   
**KILNER-DOUGHTY**  
**EM1000.05**



$\frac{1}{2}$   
**DAVIS-BOYLE**  
**EM1000.09** Çocuklar için/For children  
**EM1000.10** Gençler için/For adolescents



$\frac{1}{2}$   
**DAVIS-BOYLE**  
**EM1000.35**  
Büyükler için/For adults



$\frac{1}{2}$   
**DOYEN-COLLIN**  
**EM1000.01**  
12 cm



$\frac{1}{2}$   
**DOYEN-JANSEN**  
**EM1000.02**  
14 cm



**EM1000.46**  
108 X 25 mm

**EM1000.45**  
92 X 25 mm

**EM1000.44**  
75 X 25 mm

**EM1000.43**  
62 X 25 mm



**EM1000.42**  
25 X 19 mm  
**DAVIS-BOYLE**



$\frac{1}{2}$   
**TOBOLD**  
**EM1000.04**  
16 cm



$\frac{1}{2}$   
**HARTMANN**  
**EM1000.07**  
15 cm



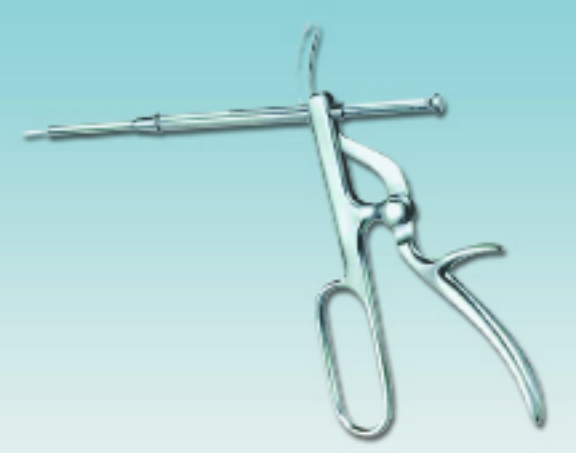

## Larynx & Tonsils (Mouthgags & Tongue Depressors)



1/2

**DENHARDT  
EM1000.48**

Değiştirilebilir silikon parçalı  
Silicon inserts interchangeable  
12.5 cm



1/2

**FERGUSSON-ACKLAND  
EM1000.49**

14.5 cm



1/2

**ROSER-KÖNIG  
EM1000.50**

16 cm



1/2

**ROSER-KÖNIG  
EM1000.51**

18.5 cm

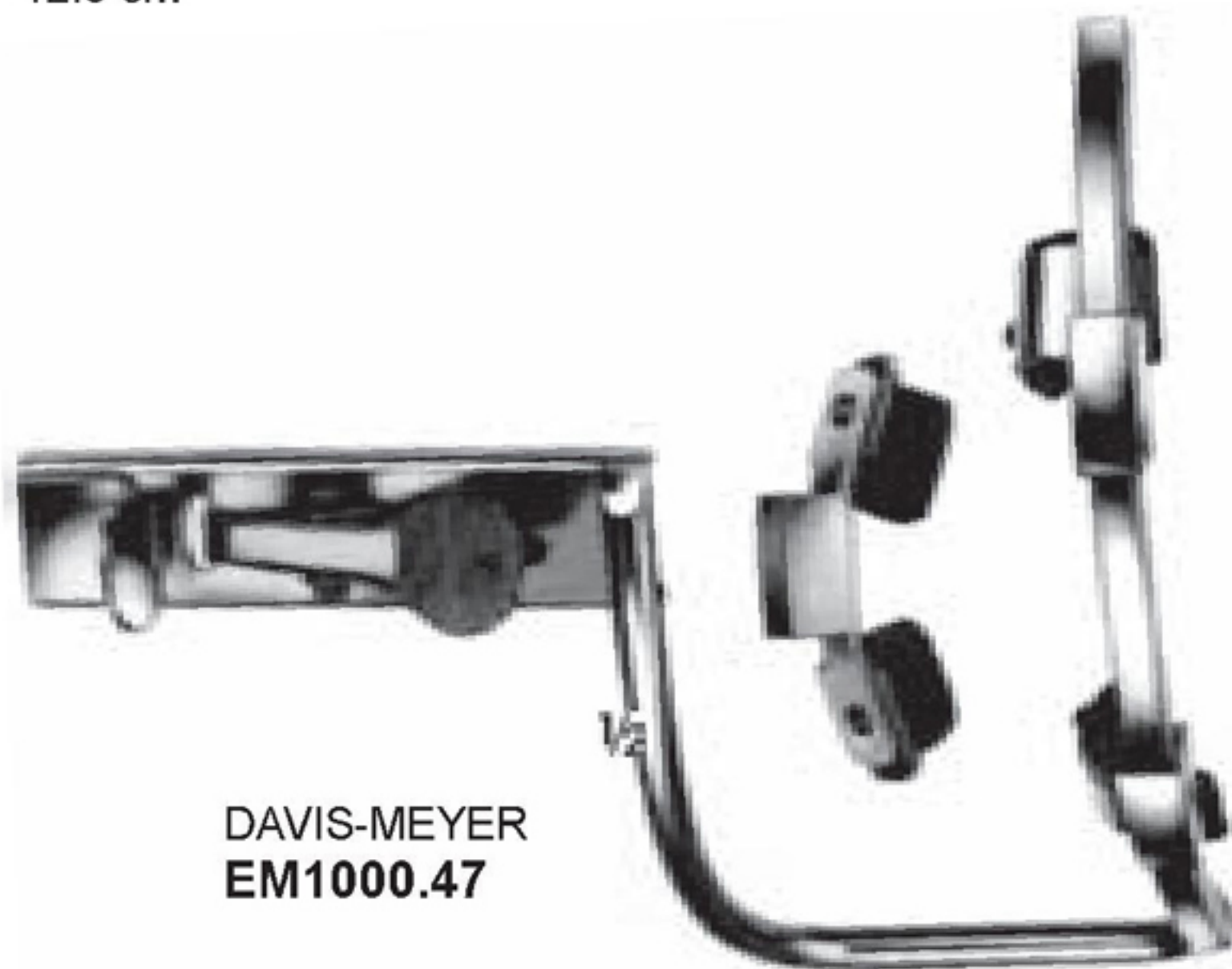

**DAVIS-MEYER  
EM1000.47**



**EM1000.30**  
67 X 29 mm

**EM1000.31**  
75 X 33 mm

**EM1000.32**  
85 X 38 mm

**EM1000.33**  
92 X 40 mm

1/2

**EM1000.34**  
100 X 46 mm

**RUSSEL-DAVIS  
EM1000.30 - EM1000.31**

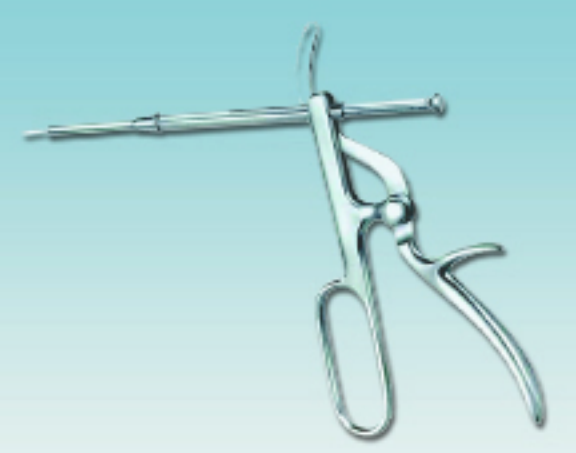

## Larynx & Tonsils (Mouthgags & Tongue Depressors)

Tongue spatulas



**MOLT**  
**EM161.11**  
11 cm/5½"



**MOLT**  
**EM161.14**  
14 cm/5½"



**SCHMID**  
**EM1000.40**



**HEISTER**  
**EM1000.41**  
13 cm



**DOYEN**  
**EM375.13A** 23 x 30 mm  
13.5 cm/5¼"  
**EM375.13** 30 x 33 mm  
16 cm/6¼"

19 x 15 mm



**BRUENINGS**  
**EM385.19**  
19 cm/7½"



**EM350.16**  
16 cm/6¼"

Cheek retractor  
Swivel  
35 mm



**EM384.19**  
19 cm/7½"

24 x 27 mm



**COLLIN**  
**EM452.17**  
17 cm/6¾"

Tongue holding forceps



**YOUNG**  
**EM467.17**  
15 cm/6"

Pair Rubber Inserts



**EM468.02**

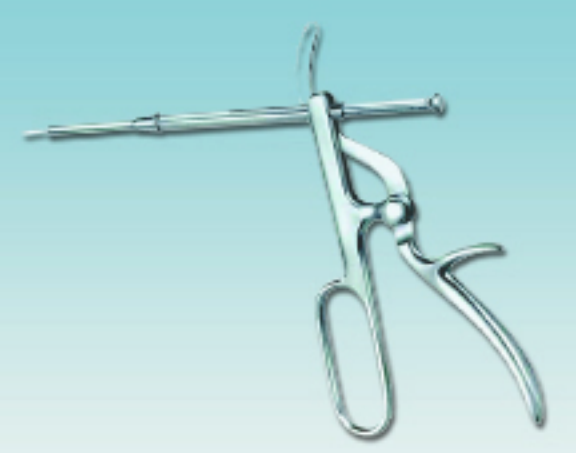

## Larynx & Tonsils (Tracheal Dilators & Tracheal Hooks)



**LABORDE**  
**EY113.14**  
14 cm/5½"



**TROUSSEAU**  
**EY115.14**  
14.5 cm/5¾"



**ITERSON**  
Sharp Blunt  
17 cm/6¾" **EY125.16** **EY127.16**



**ROSE**  
**EY143.13**  
15.5 cm/6¼"



**LUER**  
**EY145.11**  
11 cm/4½"



**LAHEY**  
15.5 cm/6¼" **EY449.15**  
20.0 cm/8" **EY449.20**



**LUKENS**  
**EY151.17**  
11 cm/4¼"



**JACKSON**  
**EY155.17**  
18 cm/7¼"



**KOCHER**  
**EY411.15**  
15.5 cm/6¼"



**KOCHER**  
**EY413.15**  
15.5 cm/6¼"  
with eye