



Neurosurgery (Skull Traction Tongs)



Wire saws

GIGLI

- 30 cm/11" **NU600.30**
- 40 cm/16" **NU600.40**
- 50 cm/20" **NU600.50**
- 60 cm/24" **NU600.60**
- 70 cm/28" **NU600.70**



Wire saw handle

GIGLI
NU602.01

Wire saw guide



DE MARTEL
NU618.33
33 cm/13"



Medium pattern

CRUTCHFIELD
NU641.02

Drill point
Ø 3.5 mm



NU641.04
7 cm/2¾"

Ø 5 mm



NU641.05
7 cm/2¾"



GARDNER-WELLS
NU641.00

Maksimum açıklık (16 cm)
Maximum opening (16 cm)

NU641.01
Small pattern



CRUTCHFIELD

NU643.01
Large pattern



NU643.10

Spare pin for
32-7643-01



Neurosurgery (Carnial Rongeurs)

with 3 hooks



DAHLGREN
NU654.20
19.5 cm/7¾"

with 2 hooks



DE VII
NU658.21
21 cm/8¼"

Cranial Punch



CONE
NU659.22
22.5 cm/8¾"

Clip Applying Forceps



MCKENZIE
NU663.19
18.5 cm/7¼"



RANEY
NU676.00
15.5 cm/6"

Clip Applying Forceps



OLIVECRONA-TOENNIS
NU661.14



Neurosurgery (Dissectors)

Galea hook



YASARGIL
30 cm/11" **NU678.01**
41 cm/16¼" **NU678.02**



TOENNIS
NU680.25
24 cm/9½"



OLIVECRONA
NU681.24
24 cm/9½"



OLIVECRONA
NU682.18
18 cm/7"



OLIVECRONA
NU683.24
24 cm/9½"



OLIVECRONA
NU684.19
20 cm/8"



SACHS
NU685.21
20.5 cm/8¼"



MILLIGAN
NU686.21
22 cm/8¾"

Fig. 1



PENFIELD
NU690.01
17.5 cm/7"

Fig. 2



PENFIELD
NU690.02
19.5 cm/7¾"

Fig. 3



PENFIELD
NU690.03
19.5 cm/7¾"

Fig. 4



PENFIELD
NU690.04
20.5 cm/8"

Fig. 5



PENFIELD
NU690.05
18.5 cm/7¼"



NU688.22
22 cm/8¾"



Neurosurgery (Dissectors & Hooklets)



DAVIS
NU687.21
21.5 cm/8½"

DAVIS
NU691.24
24.5 cm/9¾"



CUSHING
19 cm/7½"
28 cm/11"



Fig. 1
NU742.19

Fig. 2
NU744.28



FRAZIER
NU530.38
Dissektor/Dissector
15 cm

HOEN
NU530.39

HOEN
NU530.40



ADSON
20 cm/8"

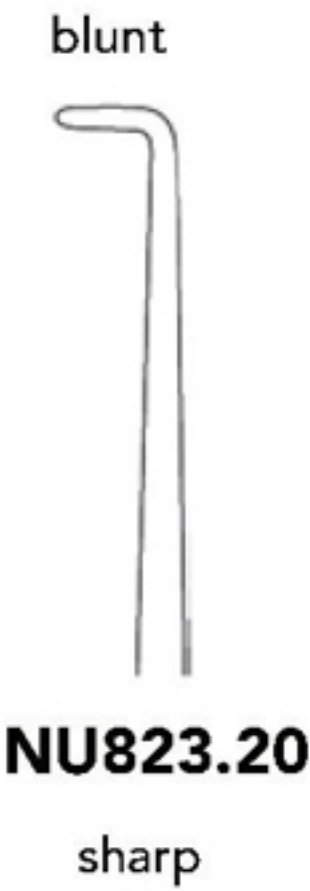

blunt
NU823.20

sharp
NU824.20



GRAHAM
NU825.16
16.5 cm/6½"



SACHS
NU827.18
17 cm/6¾"

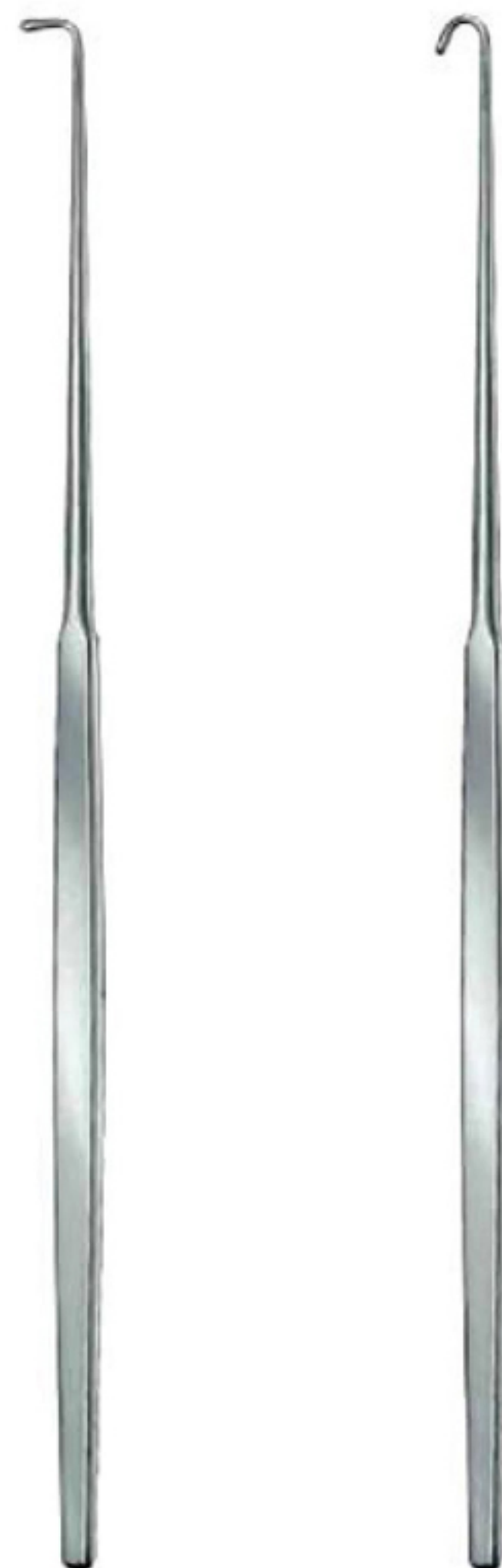

GRONINGEN
NU738.26
26.5 cm/10½"

GRONINGEN
NU740.26
26.5 cm/10½"



SMITHWICK
16.5 cm/6½"
21 cm/8¼"
NU748.17
NU748.21



19 cm/7½"

NU830.19

NU831.19



FRAZIER
13 cm/5"
18 cm/7"
NU835.13
NU835.18

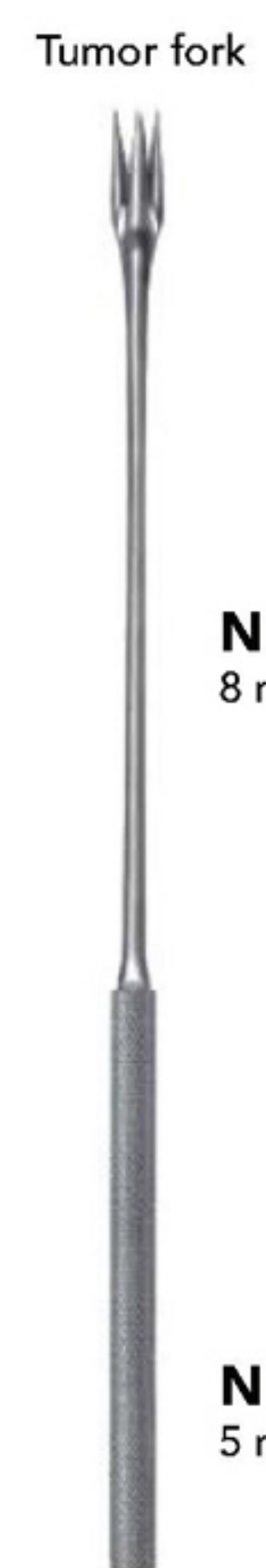

YASARGIL
20 cm/8"

NU853.01
8 mm

NU853.02
5 mm



Neurosurgery (Dissectors & Hooklets)

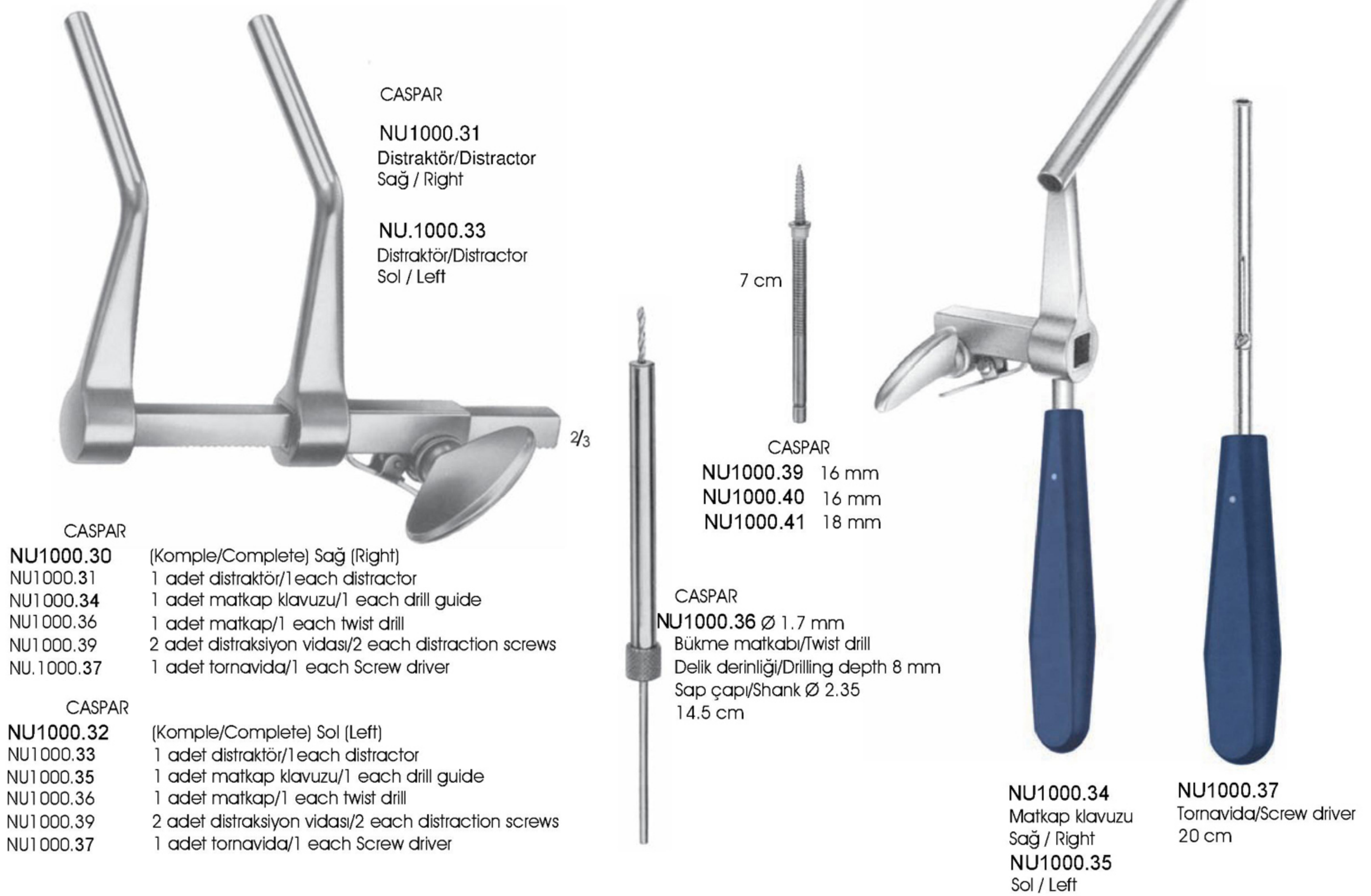
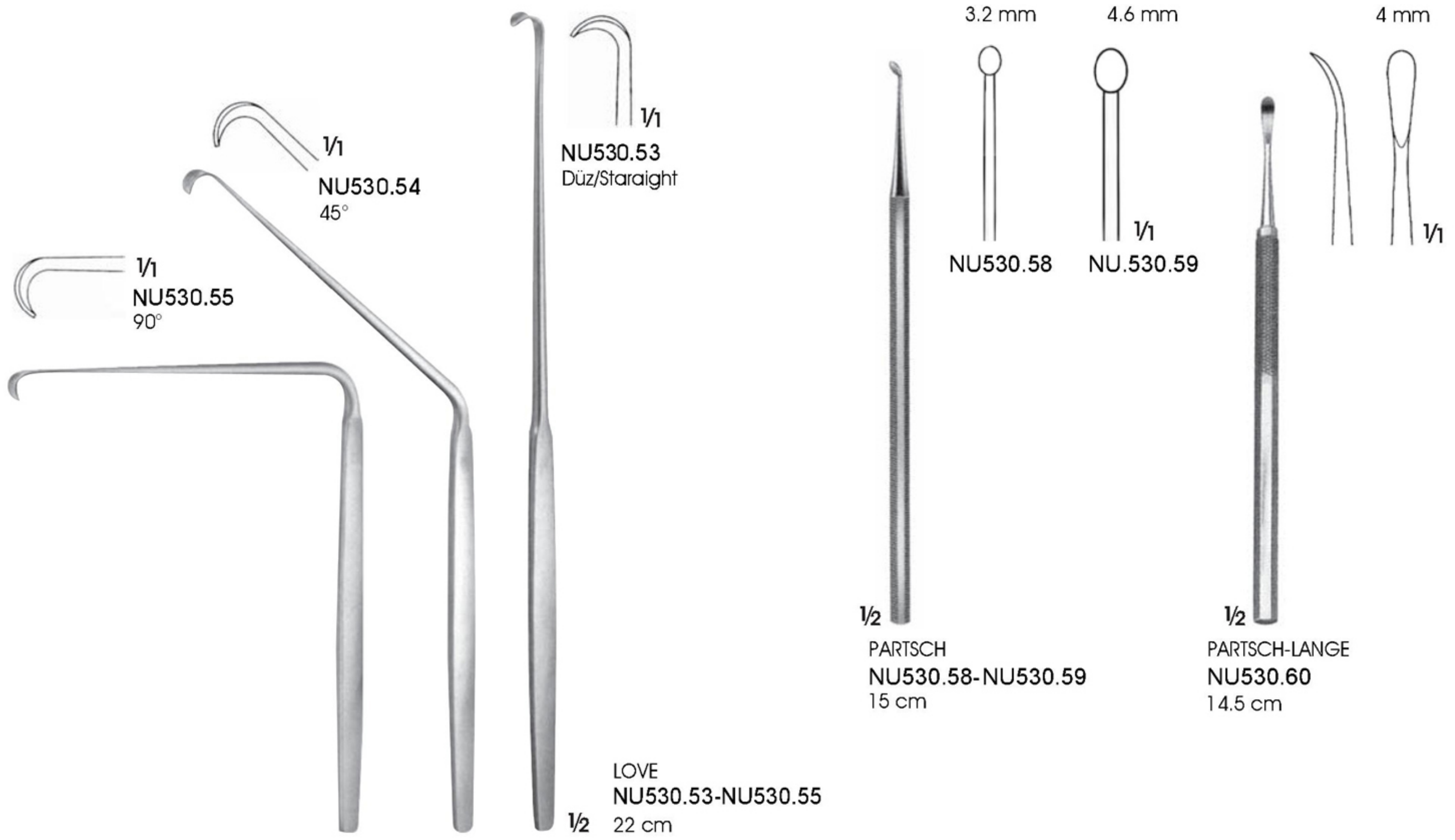



Neurosurgery (Micro & Neuro Instruments)

Tissue claw



NU853.03
18.5 cm/7"

Suture guide



YASARGIL
18.5 cm/7 1/4"

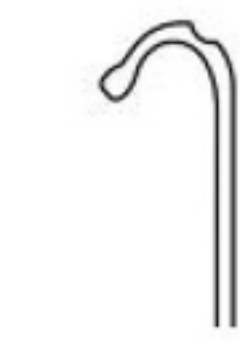

NU860.01
Fig. 1



NU860.02
Fig. 2



NU860.03
Fig. 3



NU860.04
Fig. 4

Micro raspatory



YASARGIL



NU862.01
18.5 cm/7 1/4"

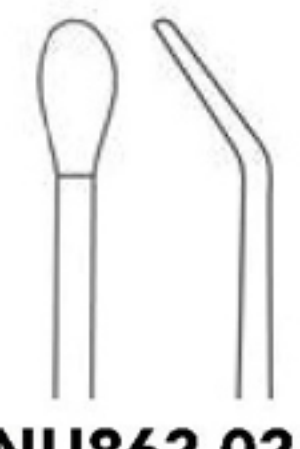

NU862.02
18.5 cm/7 1/4"

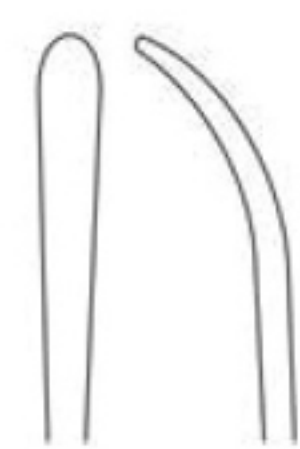

NU862.03
18.5 cm/7 1/4"

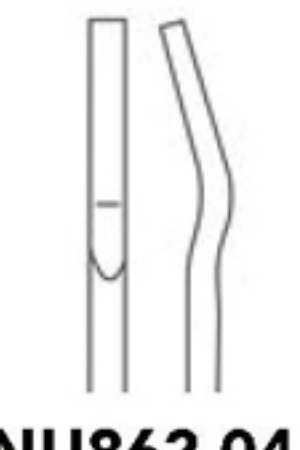

NU862.04
18.5 cm/7 1/4"



NU862.05
23 cm/9"



NU862.06
23 cm/9"

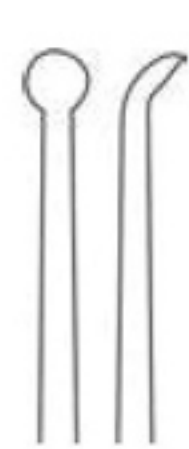

NU862.07
23 cm/9"

Tumor knife



SAMII
23 cm/9"



- 1.0 mm **NU854.01**
- 1.5 mm **NU854.02** **NU854.09**
- 2.0 mm **NU854.03**
- 2.5 mm **NU854.04**
- 3.0 mm **NU854.05** **NU854.10**
- 3.5 mm **NU854.06**
- 4.0 mm **NU854.07**
- 4.5 mm **NU854.11**
- 5.0 mm **NU854.08**
- 6.0 mm **NU854.12**

Micro raspatory bayonet



YASARGIL
18.5 cm/7 1/4"

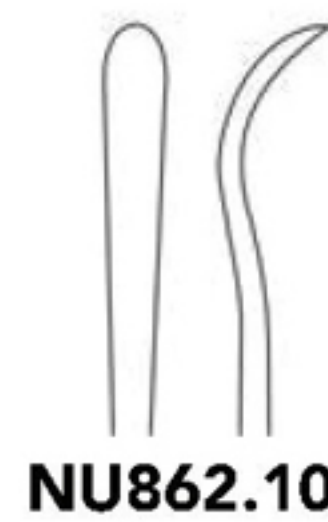

NU862.10

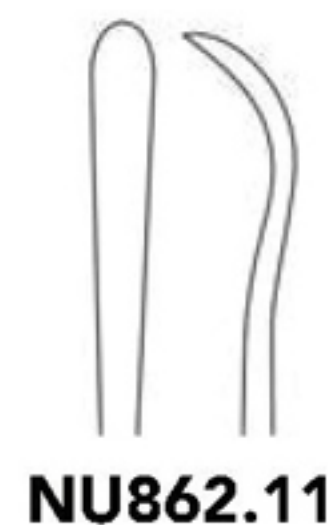

NU862.11



NU862.20

Micro dissector straight



YASARGIL

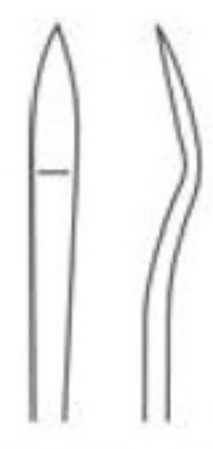

NU863.01
18.5 cm/7 1/4"



NU863.10
23 cm/9"

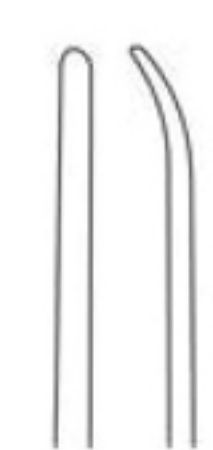

NU863.12
23 cm/9"

Micro dissector bayonet



YASARGIL
23 cm/9"



NU863.11



NU863.13

Buttoned probe



JACOBSON
NU864.02
18.5 cm/7 1/4"

Probe double



JACOBSON
NU864.01
18.5 cm/7 1/4"

Micro curette



YASARGIL
NU865.01
18.5 cm/7 1/4"



Neurosurgery (Micro & Neuro Instruments)

Micro curette



NU865.10

NU865.11

YASARGIL
23 cm/9"

Dura hook



NU866.01

NU866.02

YASARGIL
23 cm/9"

Micro hooklet



KRAYENBUEHL
19 cm/7½"



NU940.01
Fig. 1



NU940.02
Fig. 2



NU940.03
Fig. 3



NU940.04
Fig. 4

Micro dissector



CASPER



NU856.01
23 cm/9"



NU856.04
20 cm/8"

1 mm

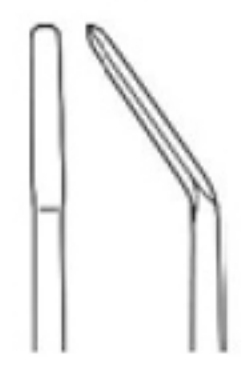

NU858.01
23 cm/9"



JACOBSON
NU858.30

Bayonet



KOOS
NU858.10
18.5 cm/7¼"

KOOS
NU858.12
18.5 cm/7¼"

YASARGIL
NU858.20
18.5 cm/7¼"

Micro vascular knife



KOOS
NU858.11
18.5 cm/7¼"



KOOS
NU858.13
18.5 cm/7¼"



YASARGIL
NU858.21
18.5 cm/7¼"

90°



NU942.05
5 mm



NU942.09
9 mm



NU942.07
7 mm

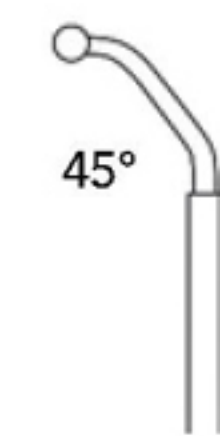

NU942.11
11 mm

CASPER
24.5 cm/9¾"

bayonet



CASPER

4.5 mm



NU856.02
23 cm/9"

1.0 mm



NU856.05
20 cm/8"

Sutue Fork



NU856.10
23 cm/9"

2.0 mm

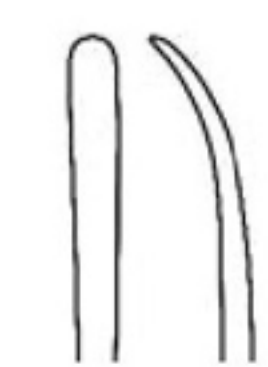

NU856.03
23 cm/9"

1.0 mm

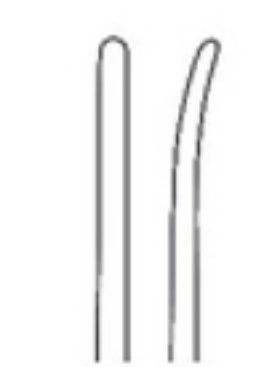

NU856.06
20 cm/8"



Neurosurgery (Lamina Spreaders)



INGE
NU977.27
25.5 cm/10"



CLOWARD
NU973.15

Tam açıklık/Total opening 4.5 cm
13.5 cm



CLOWARD
NU973.16
16 cm/6¼"



INGE
NU975.17
16 cm/6¼"



CLOWARD
NU974.17
16 cm/6¼"



Neurosurgery (Rongeurs)

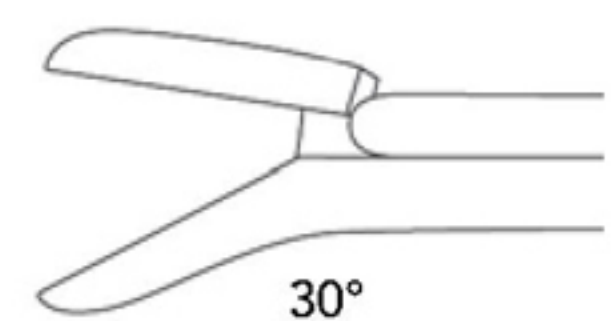
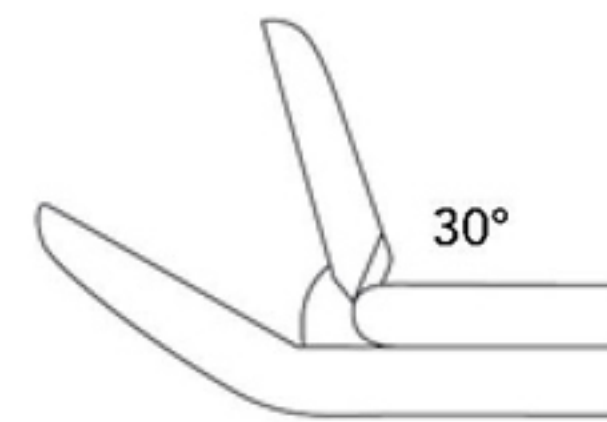
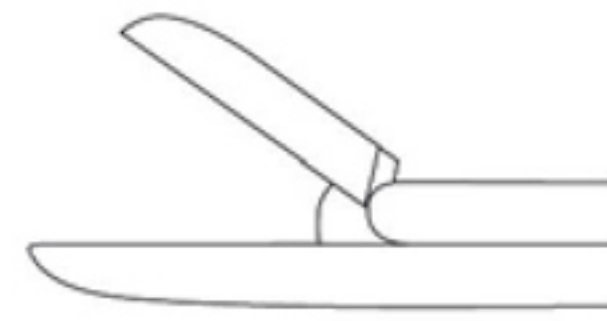
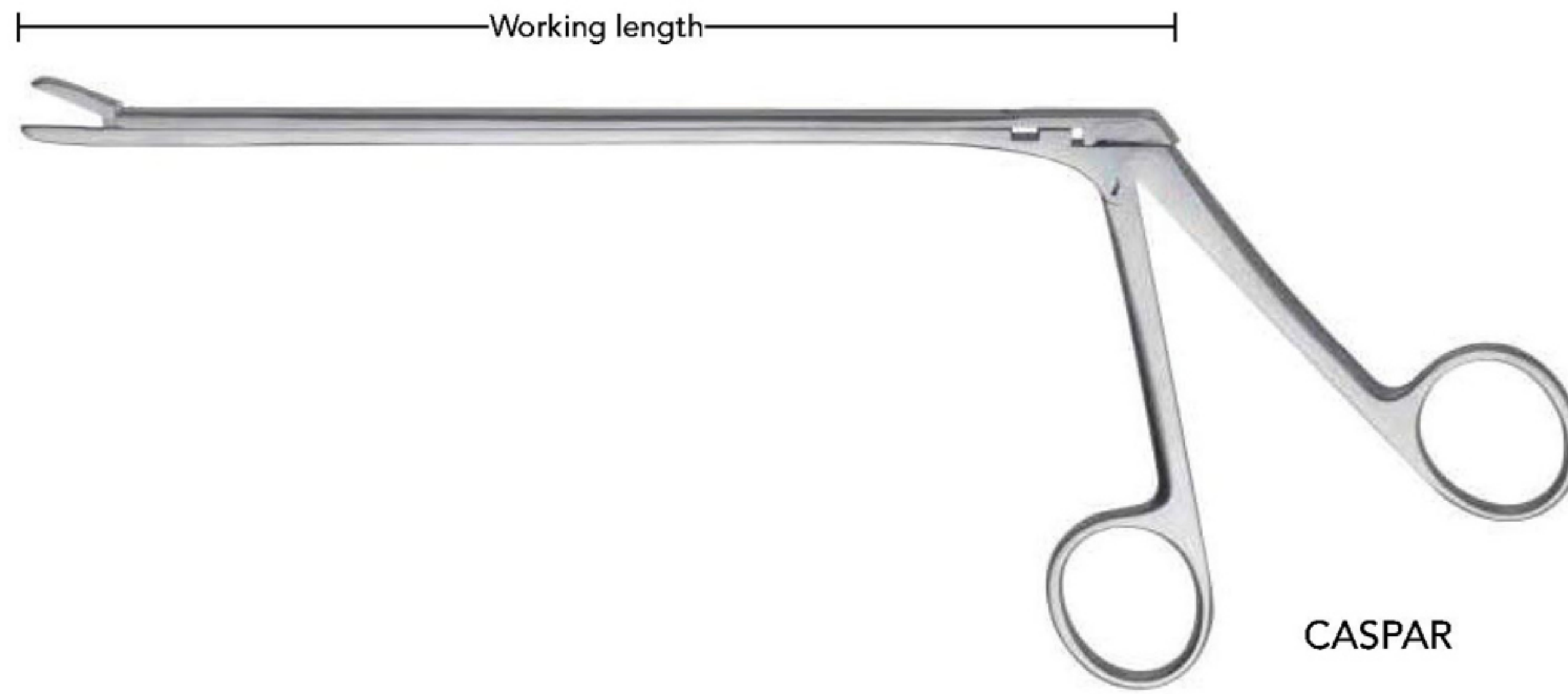

2 mm	Working length	15 cm/6"	NU981.05	NU982.05	NU981.25	NU982.25	NU981.45	NU982.45
		18 cm/7"	NU981.09	NU982.09	NU981.29	NU982.29	NU981.49	NU982.49
		20 cm/8"	NU981.13	NU982.13	NU981.33	NU982.33	NU981.53	NU982.53
		30 cm/11¾"	NU981.17	NU982.17	NU981.37	NU982.37	NU981.57	NU982.57
3 mm	Working length	15 cm/6"	NU981.06	NU982.06	NU981.26	NU982.26	NU981.46	NU982.46
		18 cm/7"	NU981.10	NU982.10	NU981.30	NU982.30	NU981.50	NU982.50
		20 cm/8"	NU981.14	NU982.14	NU981.34	NU982.34	NU981.54	NU982.54
		30 cm/11¾"	NU981.18	NU982.18	NU981.38	NU982.38	NU981.58	NU982.58
4 mm	Working length	15 cm/6"	NU981.07	NU982.07	NU981.27	NU982.27	NU981.47	NU982.47
		18 cm/7"	NU981.11	NU982.11	NU981.31	NU982.31	NU981.51	NU982.51
		20 cm/8"	NU981.15	NU982.15	NU981.35	NU982.35	NU981.55	NU982.55
		30 cm/11¾"	NU981.19	NU982.19	NU981.39	NU982.39	NU981.59	NU982.59
5 mm	Working length	15 cm/6"	NU981.08	NU982.08	NU981.28	NU982.28	NU981.48	NU982.48
		18 cm/7"	NU981.12	NU982.12	NU981.32	NU982.32	NU981.52	NU982.52
		20 cm/8"	NU981.16	NU982.16	NU981.36	NU982.36	NU981.56	NU982.56
		30 cm/11¾"	NU981.20	NU982.20	NU981.40	NU982.40	NU981.60	NU982.60

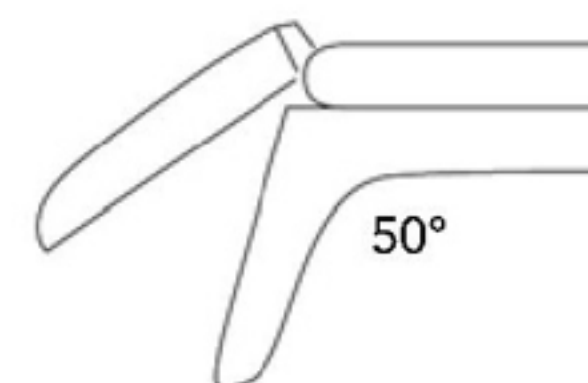
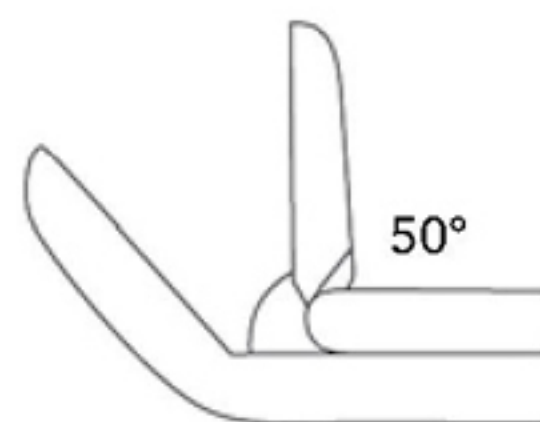

4 mm	Working length	18 cm/7"	NU980.80	NU984.80	Working length	18 cm/7"	NU982.80	NU986.80
		30 cm/11¾"	NU981.81	NU985.81		30 cm/11¾"	NU983.81	NU987.81



Neurosurgery (Rongeurs)

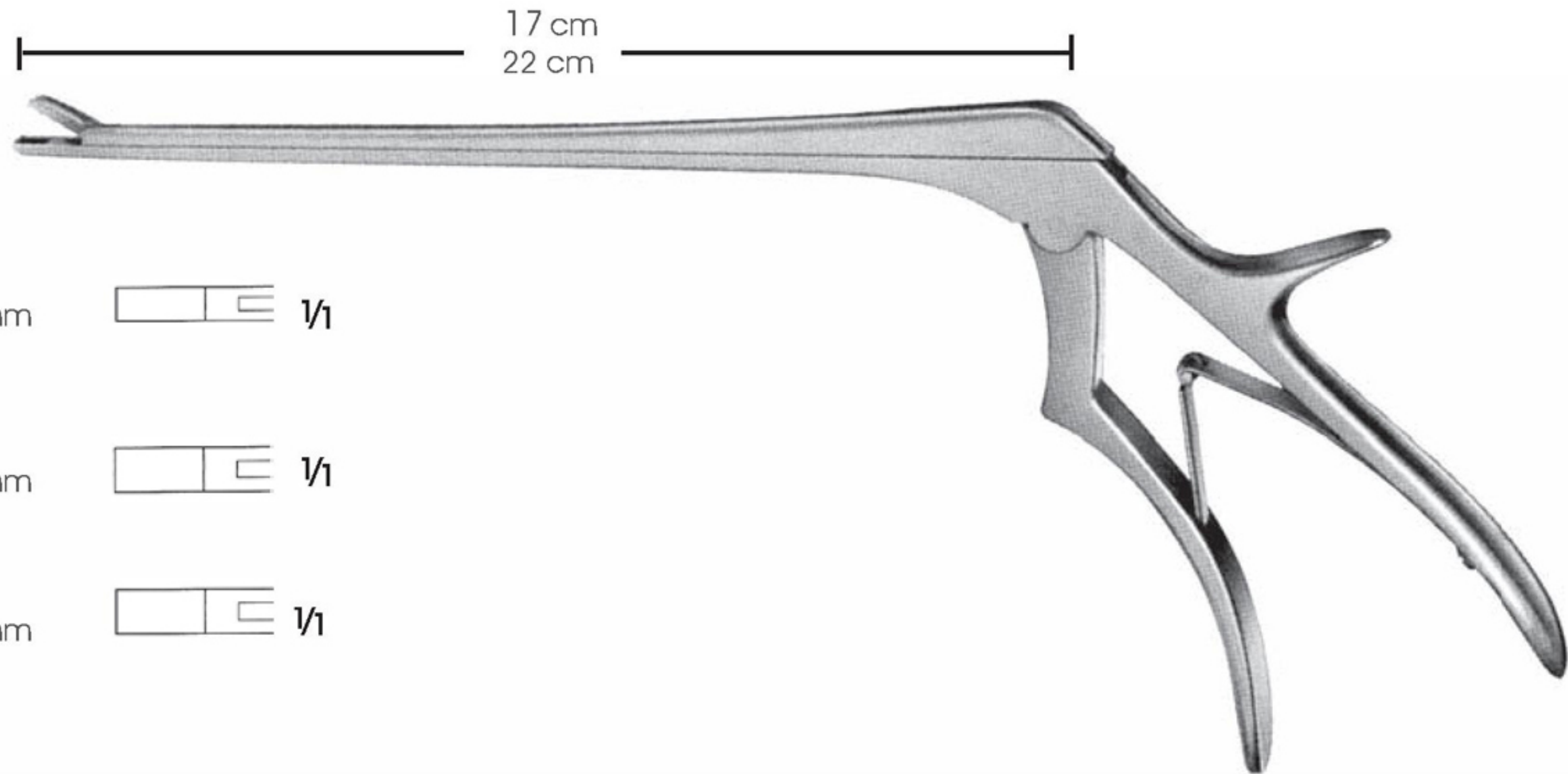

CASPAR
NU500.34 3 mm
18 cm

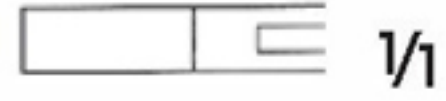

CASPAR
NU500.35 4 mm
18 cm



CASPAR
NU500.36 4 mm
20.5 cm

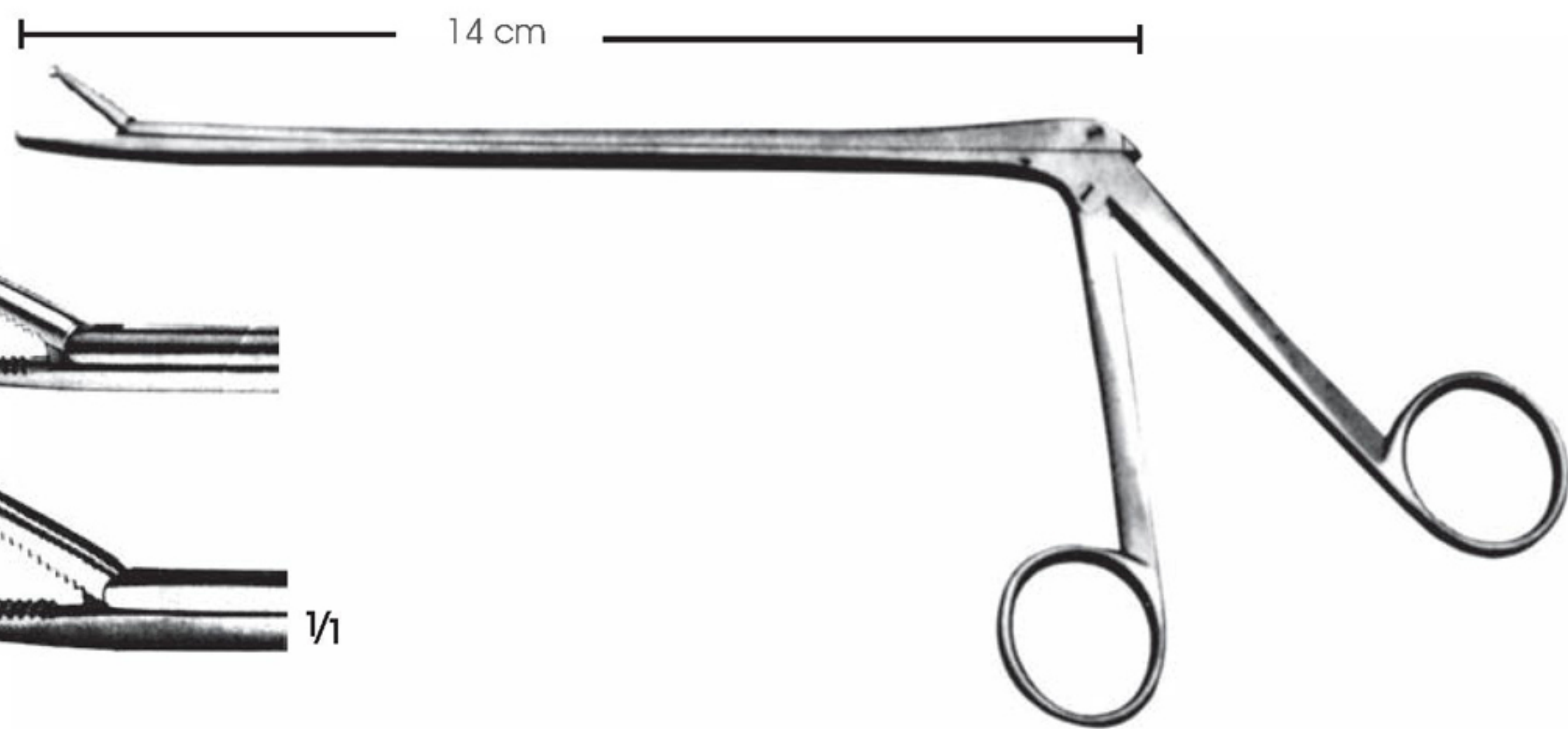

HOEN
NU500.37

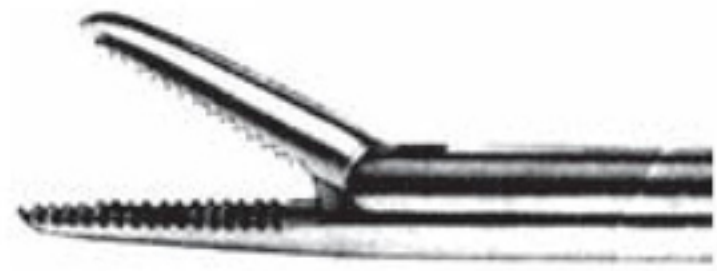

NU500.38

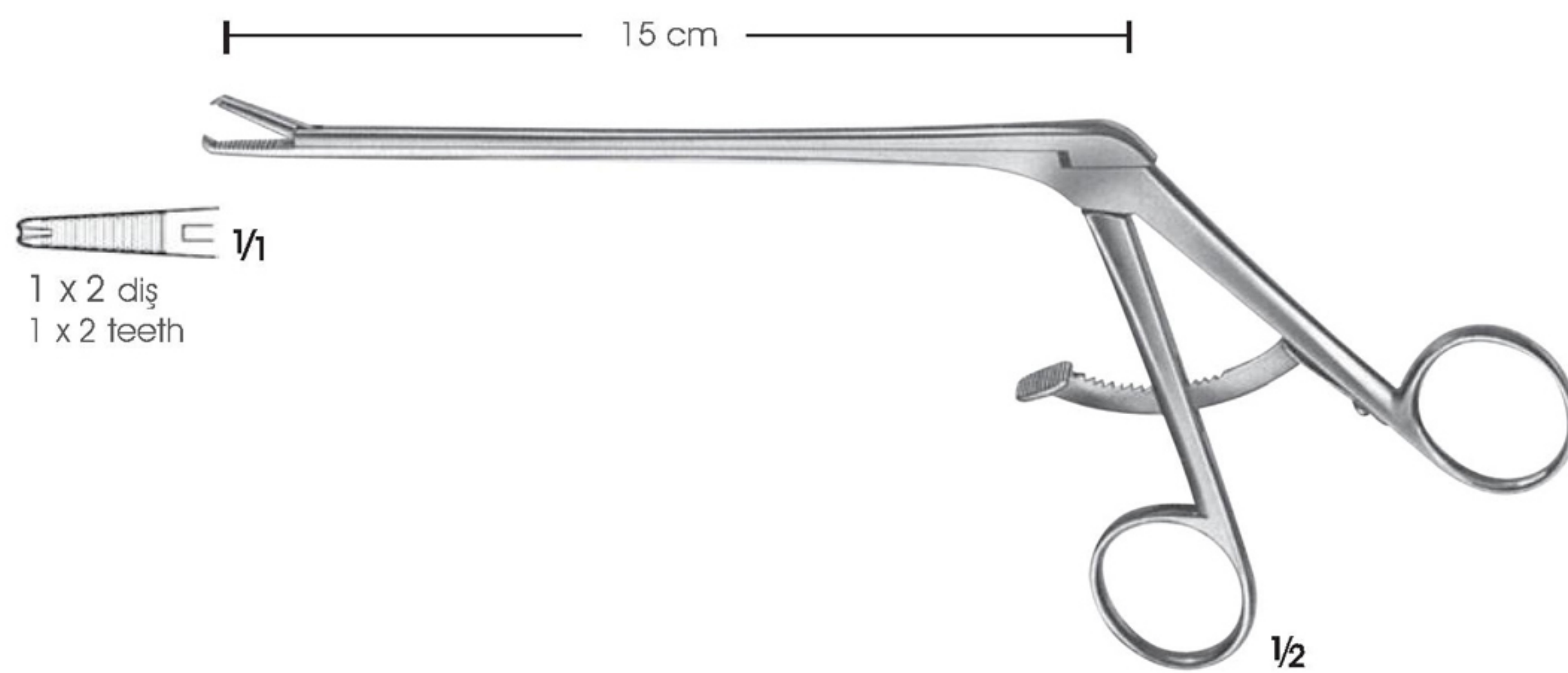
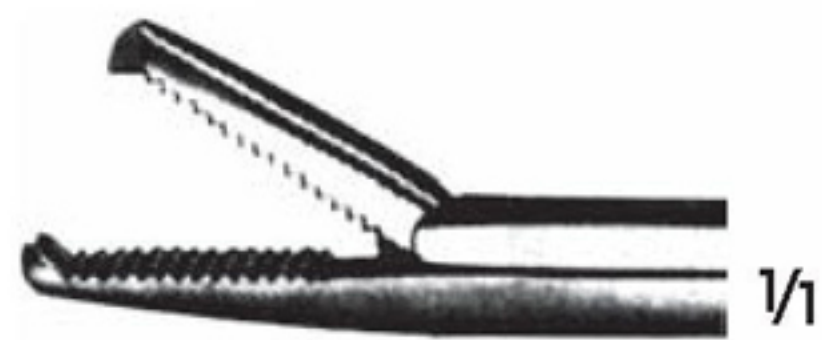

KRAMER
NU500.39 15 cm
Bağ tutucu grasping pens, kilittli
With catch grasping forceps for
ligamentum flavum



Neurosurgery (Rongeurs)

Mil uzunluđu
Length of shaft

Mil uzunluđu
Length of shaft

Mil uzunluđu Length of shaft	Mil uzunluđu Length of shaft	Mil uzunluđu Length of shaft	Çene ölçüleri Size of jaws
14 cm NU500.04	16 cm NU500.09	18.5 cm NU500.14	2 x 12 mm
14 cm NU500.05	16 cm NU500.10	18.5 cm NU500.15	3 x 12 mm
14 cm NU500.06	16 cm NU500.11	18.5 cm NU500.16	4 x 14 mm
14 cm NU500.07	16 cm NU500.12	18.5 cm NU500.17	5 x 14 mm
14 cm NU500.08	16 cm NU500.13	18.5 cm NU500.18	6 x 16 mm

CASPAR
NU500.04-NU500.18

Mil uzunluđu
Length of shaft

150°

Mil uzunluđu
Length of shaft

Mil uzunluđu Length of shaft	Mil uzunluđu Length of shaft	Mil uzunluđu Length of shaft	Çene Ölçüleri Size of jaws
14 cm NU500.19	16 cm NU500.22	18.5 cm NU500.25	3 x 12 mm
14 cm NU500.20	16 cm NU500.23	18.5 cm NU500.26	4 x 14 mm
14 cm NU500.21	16 cm NU500.24	18.5 cm NU500.27	5 x 14 mm

CASPAR
NU500.19-NU500.27

Mil uzunluđu
Length of shaft

Alt çene hareketli
Lower part of jaw movable

150°

Mil uzunluđu
Length of shaft

Mil uzunluđu Length of shaft	Mil uzunluđu Length of shaft	Mil uzunluđu Length of shaft	Çene Ölçüleri Size of jaws
14 cm NU500.28	16 cm NU500.30	18.5 cm NU500.32	3 x 12 mm
14 cm NU500.29	16 cm NU500.31	18.5 cm NU500.33	4 x 14 mm

CASPAR
NU500.28-NU500.33



Neurosurgery (Rongeurs)

LOVE-GRUENWALD

NU500.01 2 x 10 mm



NU500.02 3 x 10 mm

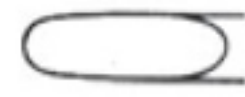

SPURLING

NU500.03 4 x 10 mm



CUSHING

NU530.34 4 mm

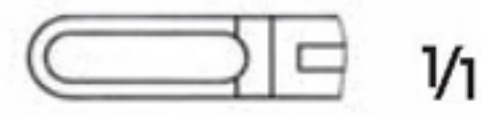

NU530.35 5 mm



NU530.36 6 mm

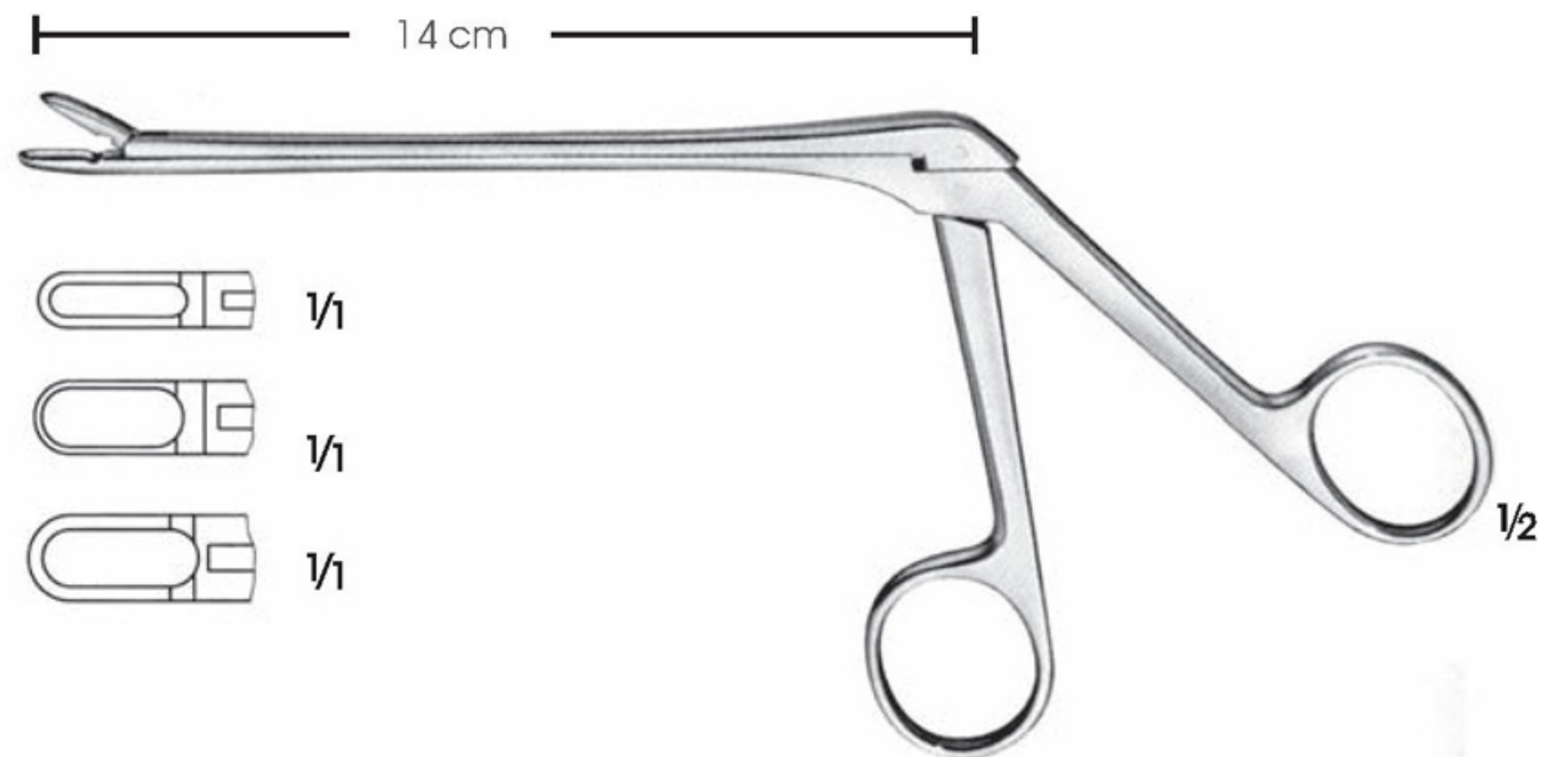

CUSHING

NU530.41 3 mm



NU530.42 4 mm

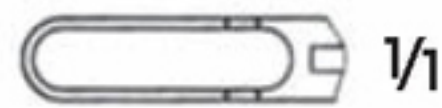

NU530.43 5 mm

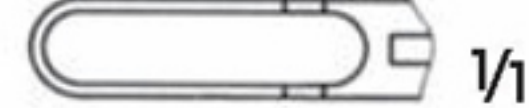

CUSHING

NU530.44 3 mm



NU530.45 4 mm

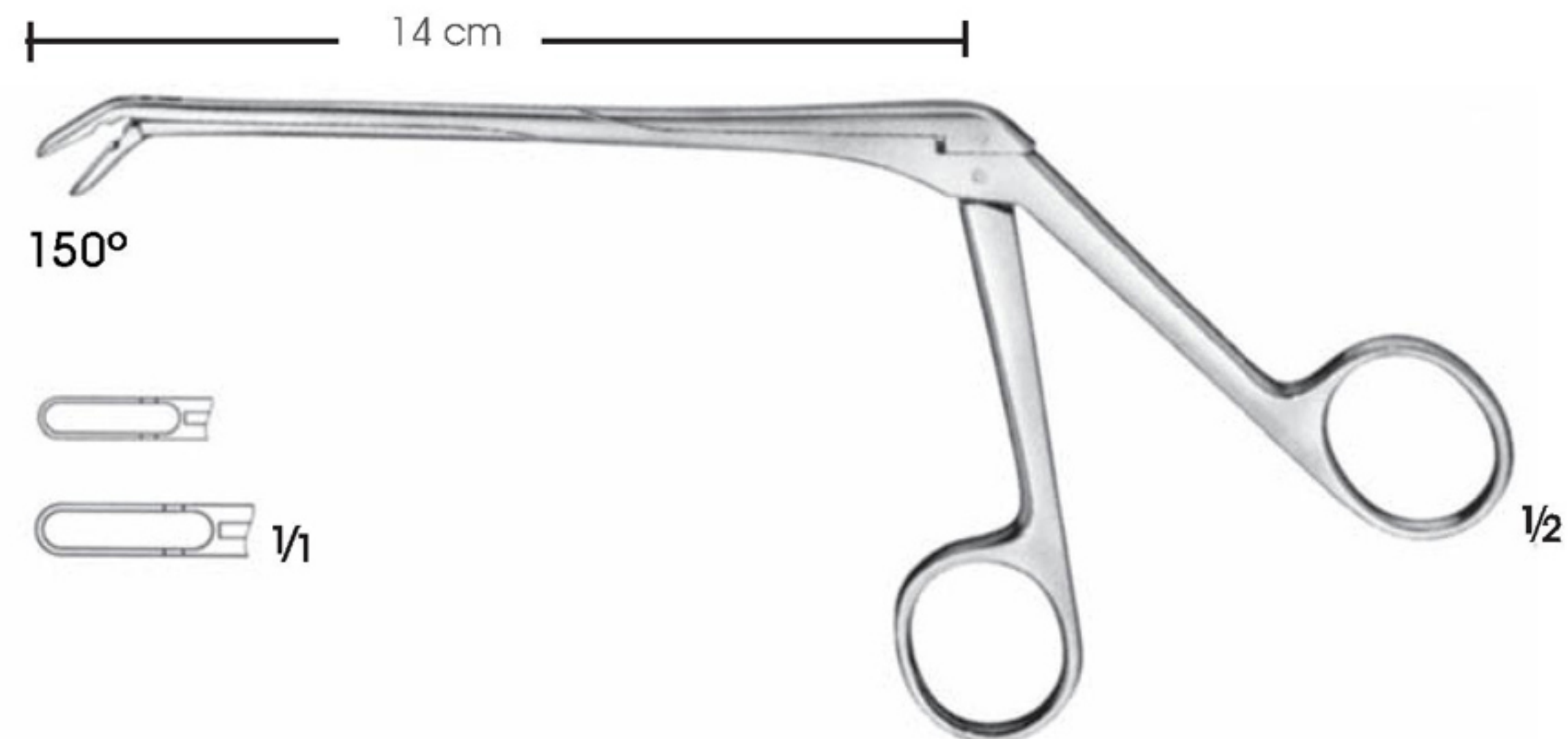



Neurosurgery (Rongeurs)

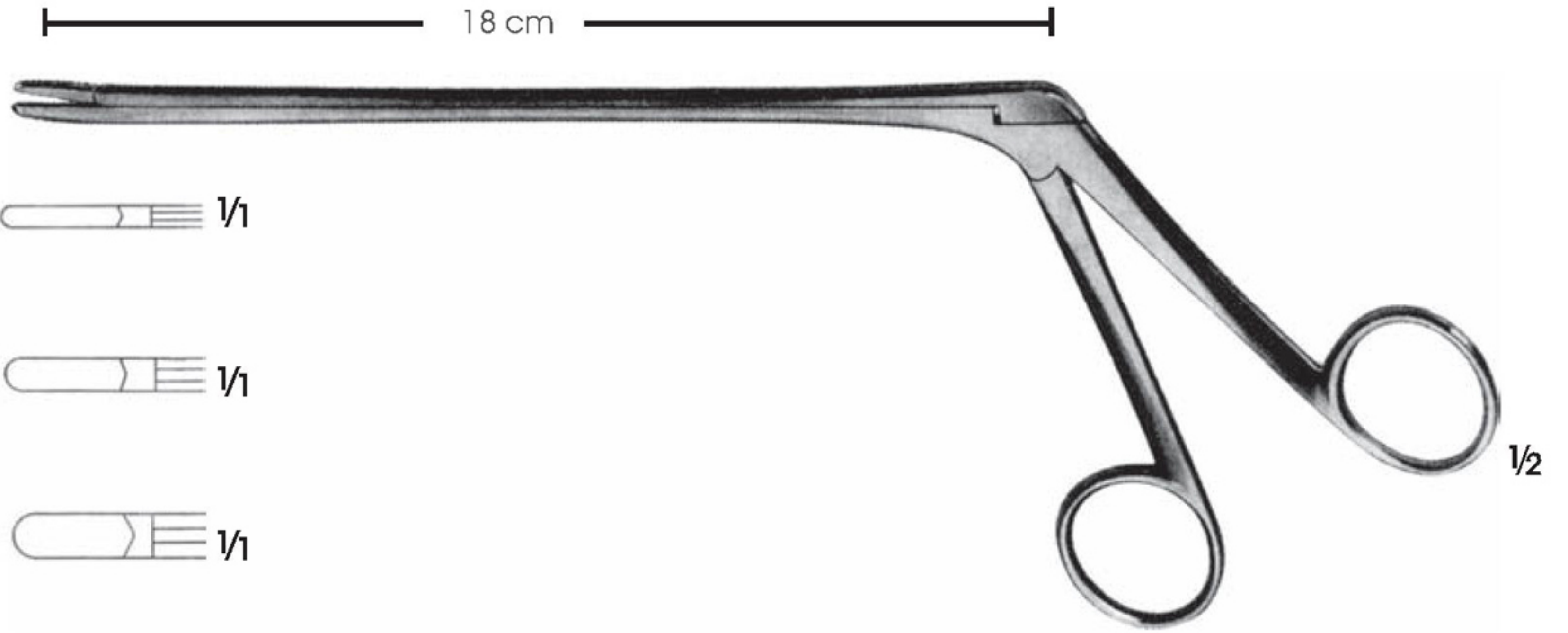

Üst çene hareketli
Upper part of jaw movable





Neurosurgery (Laminectomy Punches)

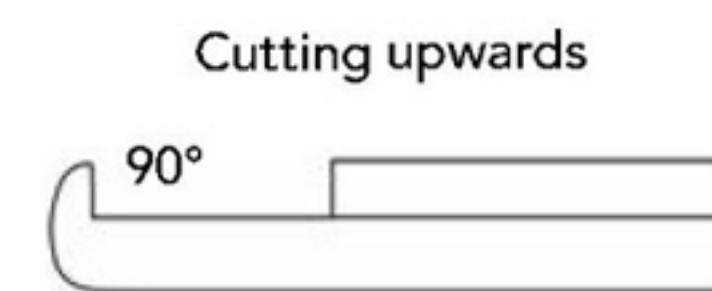
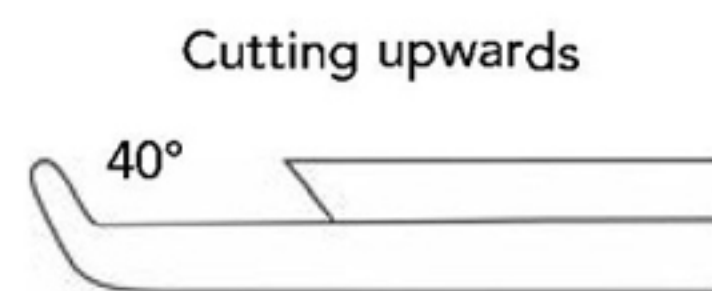
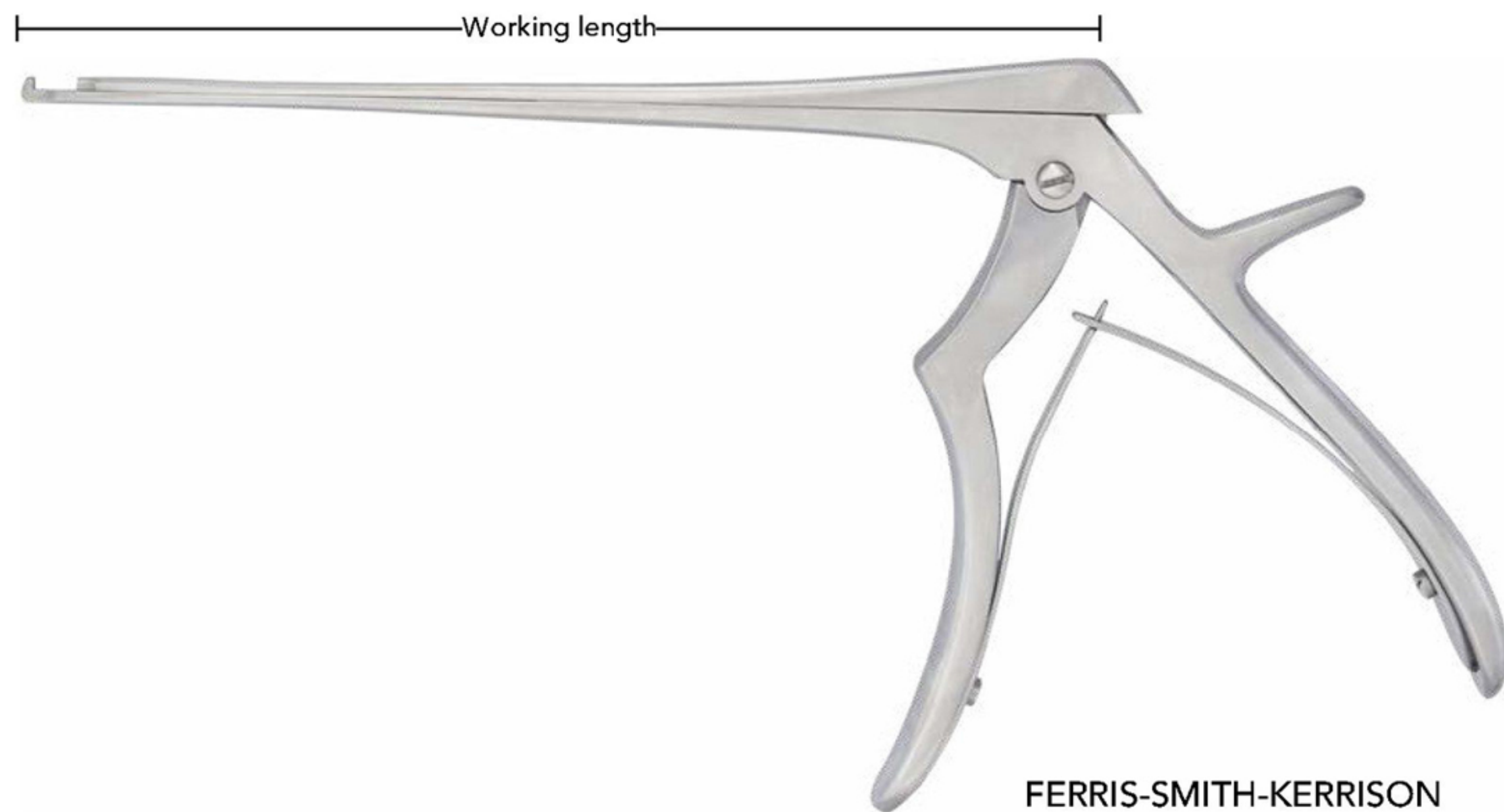





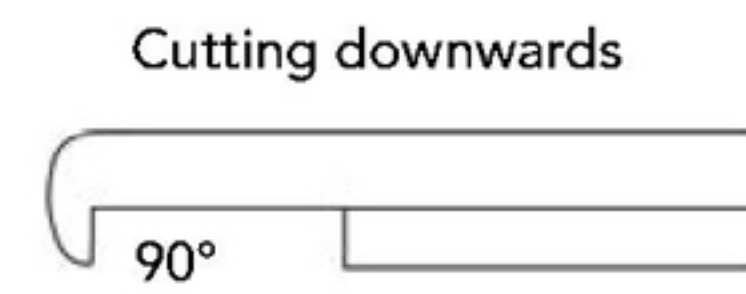
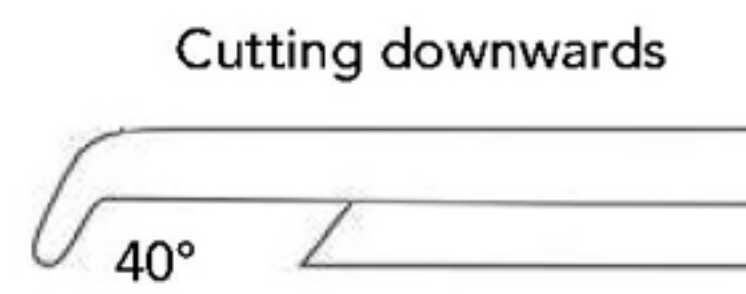
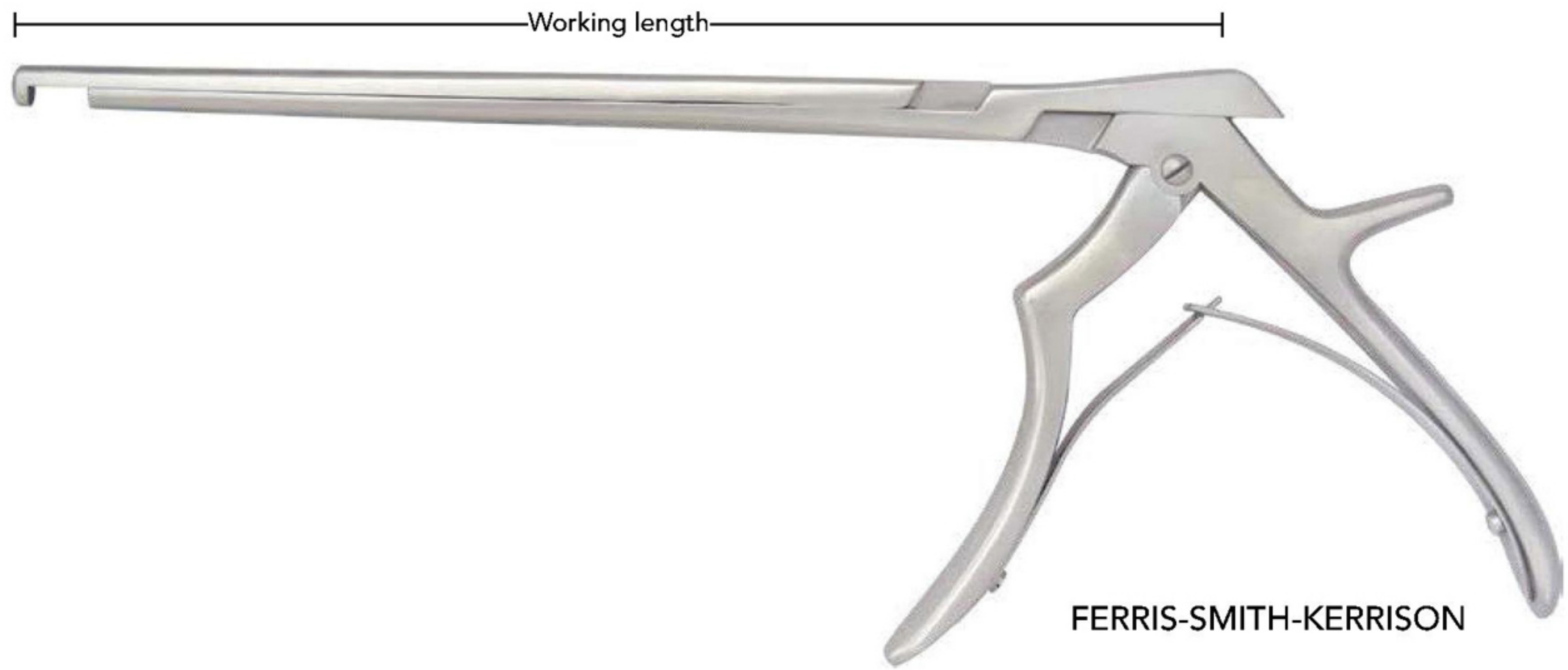

	Working length	Cutting upwards 40°			Cutting upwards 90°		
		Standard 40°	Detachable / TC 40°	Black Coated 40°	Standard 90°	Detachable / TC 90°	Black Coated 90°
1 mm	18 cm/7"	NU978.01	NU978.01DT	NU478.01	NU978.02	NU978.02DT	NU478.02
	20 cm/7¾"	NU978.03	NU978.03DT	NU478.03	NU978.04	NU978.04DT	NU478.04
	23 cm/9"	NU978.05	NU978.05DT	NU478.05	NU978.06	NU978.06DT	NU478.06
	28 cm/11"	NU978.07	NU978.07DT	NU478.07	NU978.08	NU978.08DT	NU478.08
2 mm	18 cm/7"	NU978.09	NU978.09DT	NU478.09	NU978.10	NU978.10DT	NU478.10
	20 cm/7¾"	NU978.11	NU978.11DT	NU478.11	NU978.12	NU978.12DT	NU478.12
	23 cm/9"	NU978.13	NU978.13DT	NU478.13	NU978.14	NU978.14DT	NU478.14
	28 cm/11"	NU978.15	NU978.15DT	NU478.15	NU978.16	NU978.16DT	NU478.16
3 mm	18 cm/7"	NU978.17	NU978.17DT	NU478.17	NU978.18	NU978.18DT	NU478.18
	20 cm/7¾"	NU978.19	NU978.19DT	NU478.19	NU978.20	NU978.20DT	NU478.20
	23 cm/9"	NU978.21	NU978.21DT	NU478.21	NU978.22	NU978.22DT	NU478.22
	28 cm/11"	NU978.23	NU978.23DT	NU478.23	NU978.24	NU978.24DT	NU478.24
4 mm	18 cm/7"	NU978.25	NU978.25DT	NU478.25	NU978.26	NU978.26DT	NU978.26
	20 cm/7¾"	NU978.27	NU978.27DT	NU478.27	NU978.28	NU978.28DT	NU978.28
	23 cm/9"	NU978.29	NU978.29DT	NU478.29	NU978.30	NU978.30DT	NU978.30
	28 cm/11"	NU978.31	NU978.31DT	NU478.31	NU978.32	NU978.32DT	NU978.32
5 mm	18 cm/7"	NU978.33	NU978.33DT	NU478.33	NU978.34	NU978.34DT	NU478.34
	20 cm/7¾"	NU978.35	NU978.35DT	NU478.35	NU978.36	NU978.36DT	NU478.36
	23 cm/9"	NU978.37	NU978.37DT	NU478.37	NU978.38	NU978.38DT	NU478.38
	28 cm/11"	NU978.39	NU978.39DT	NU478.39	NU978.40	NU978.40DT	NU478.40
6 mm	18 cm/7"	NU978.41	NU978.41DT	NU478.41	NU978.42	NU978.42DT	NU478.42
	20 cm/7¾"	NU978.43	NU978.43DT	NU478.43	NU978.44	NU978.44DT	NU478.44
	23 cm/9"	NU978.45	NU978.45DT	NU478.45	NU978.46	NU978.46DT	NU478.46
	28 cm/11"	NU978.47	NU978.47DT	NU478.47	NU978.48	NU978.48DT	NU478.48

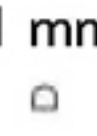

Neurosurgery (Laminectomy Punches)



	Working length	40°	40°	90°	90°
1 mm 	18 cm/7"	NU.978.50	NU478.50	NU.978.51	NU478.51
	20 cm/7 ³ / ₄ "	NU.978.52	NU478.52	NU.978.53	NU478.53
	23 cm/9"	NU.978.54	NU478.54	NU.978.55	NU478.55
2 mm 	18 cm/7"	NU978.56	NU478.56	NU978.57	NU478.57
	20 cm/7 ³ / ₄ "	NU978.58	NU478.58	NU978.59	NU478.59
	23 cm/9"	NU978.60	NU478.60	NU978.61	NU478.61
3 mm 	18 cm/7"	NU978.62	NU478.62	NU978.63	NU478.63
	20 cm/7 ³ / ₄ "	NU978.64	NU478.64	NU978.65	NU478.65
	23 cm/9"	NU978.66	NU478.66	NU978.67	NU478.67
4 mm 	18 cm/7"	NU978.68	NU478.68	NU978.69	NU478.69
	20 cm/7 ³ / ₄ "	NU978.70	NU478.70	NU978.71	NU478.71
	23 cm/9"	NU978.72	NU478.72	NU978.73	NU478.73
5 mm 	18 cm/7"	NU978.74	NU478.64	NU978.75	NU478.75
	20 cm/7 ³ / ₄ "	NU978.76	NU478.76	NU978.77	NU478.77
	23 cm/9"	NU978.78	NU478.78	NU978.79	NU478.79
6 mm 	18 cm/7"	NU978.80	NU478.80	NU978.81	NU478.81
	20 cm/7 ³ / ₄ "	NU978.82	NU478.82	NU978.83	NU478.83
	23 cm/9"	NU978.84	NU478.84	NU978.85	NU478.85



Neurosurgery (Rongeurs)

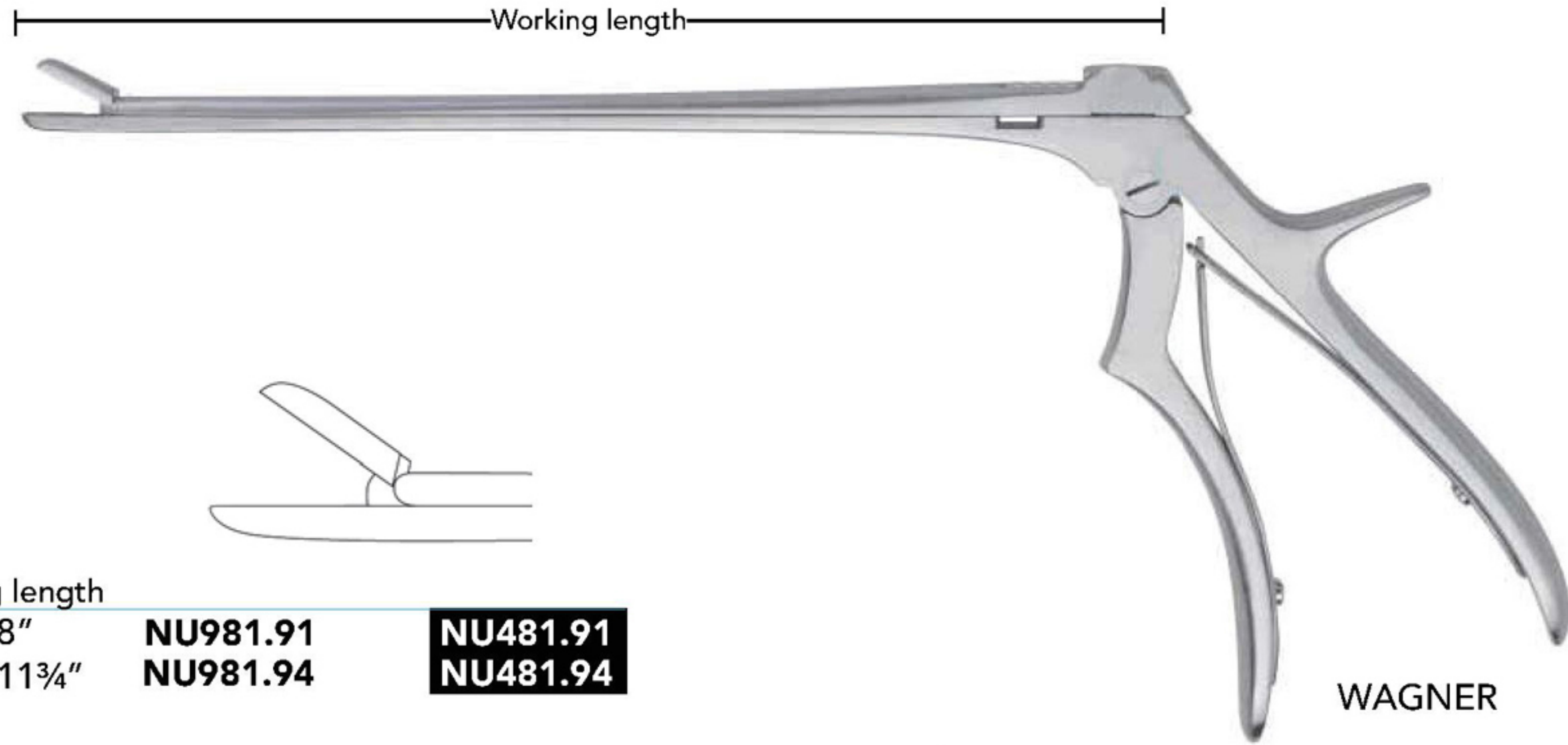

WAGNER

3 mm	Working length	NU981.91	NU481.91
	20 cm/8"		
30 cm/11¾"		NU981.94	NU481.94

4 mm	Working length	NU981.92	NU481.92
	20 cm/8"		
30 cm/11¾"		NU981.95	NU481.95

5 mm	Working length	NU981.93	NU481.93	NU981.84	NU481.84	NU981.86	NU481.86
	15 cm/6"						
18 cm/7"		NU981.96	NU481.96	NU981.85	NU481.85	NU981.87	NU481.87

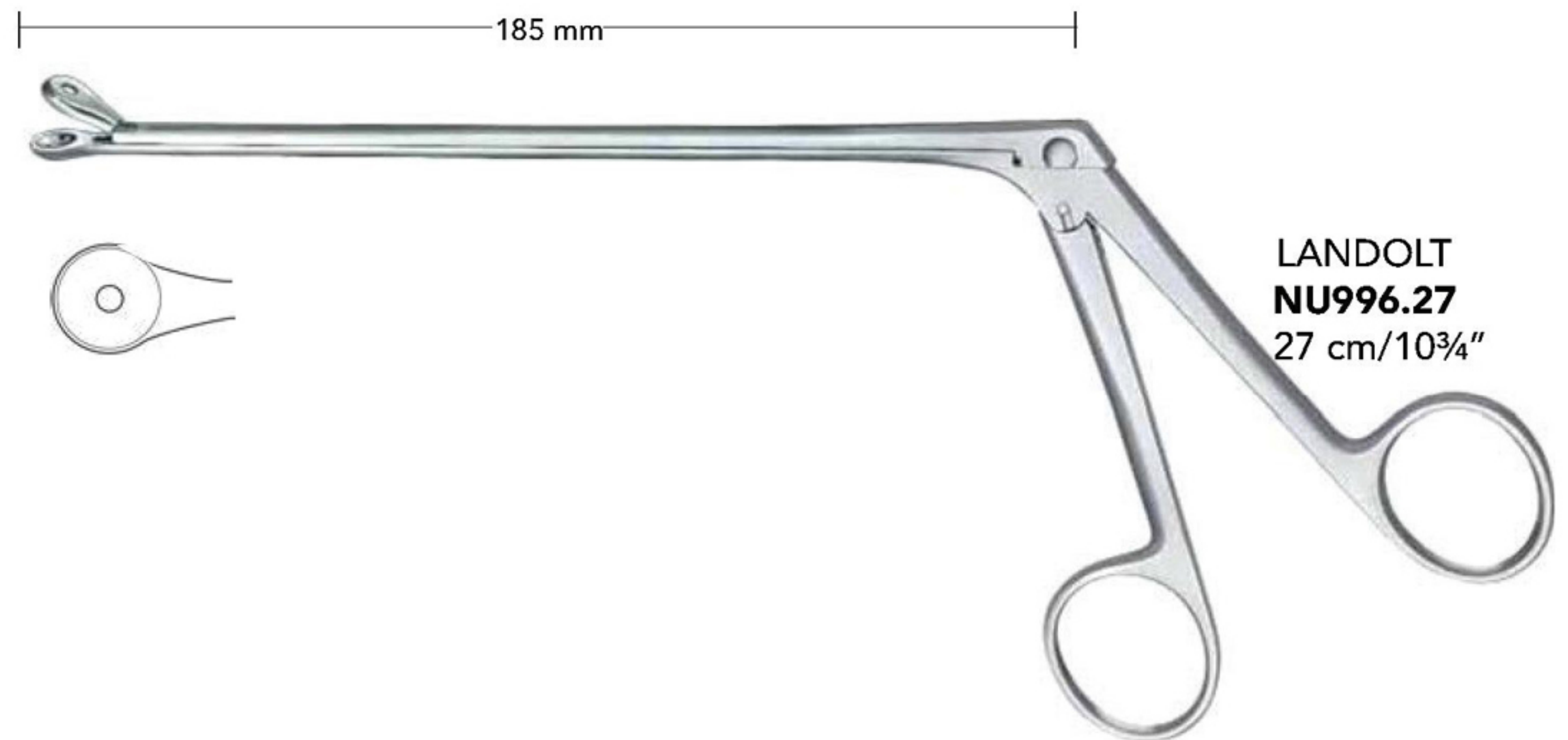

LANDOLT
NU996.27
27 cm/10¾"

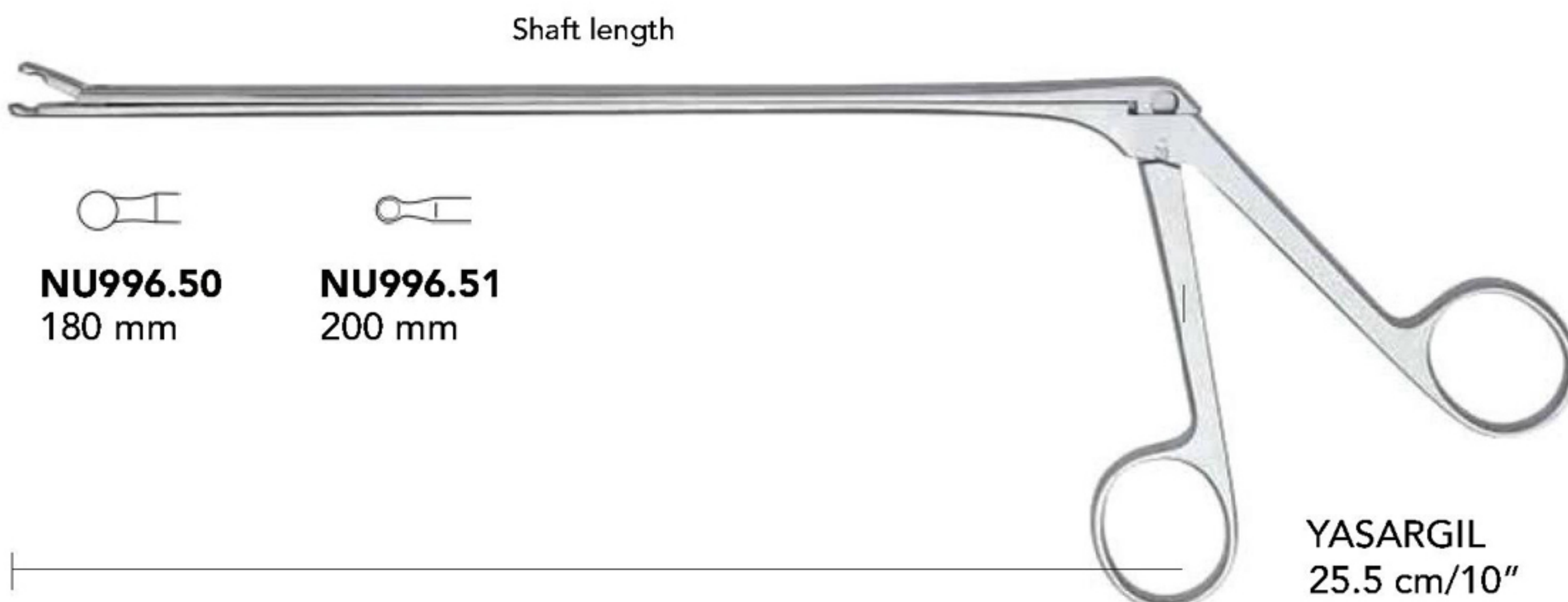

YASARGIL
25.5 cm/10"

NU996.50
180 mm

NU996.51
200 mm



Neurosurgery (Micro Forceps)

Jaw spoon-shaped

Ø 3 mm Ø 4 mm Ø 5 mm

Ø 3 mm Ø 4 mm Ø 5 mm

23 cm/9" **MT852.01** **MT852.02** **MT852.03** **MT853.01** **MT853.02** **MT853.03**

YASARGIL-SAMII

Jaw spoon-shaped Jaw flat, serrated Curette jaw, toothed

Ø 3 mm Ø 5 mm Ø 7 mm Ø 3 mm Ø 5 mm Ø 3 mm Ø 5 mm

22 cm/8¾" **MT863.22** **MT865.22** **MT867.22** 20 cm/8" **MT871.20** **MT872.20**
 24 cm/9½" **MT863.24** **MT865.24** **MT867.24** 22 cm/8¾" **MT871.22** **MT872.22** **MT873.22** **MT875.22**

YASARGIL YASARGIL

Ø 0.6 mm Ø 0.9 mm

16 cm/6¼" **MT856.16** **MT859.16**
 18 cm/7" **MT856.18** **MT859.18** **MT860.18**
 20 cm/8" **MT856.20** **MT859.20**
 22 cm/8¾" **MT856.22** **MT859.22**
 24 cm/9½" **MT856.24** **MT859.24**

1:2

Jaw flat, serrated

Ø 5 mm Ø 5 mm

MT890.20 **MT891.20**

YASARGIL HUNT
20 cm/8"



Neurosurgery (Micro Scissors)

	 MS850.03A		 MS850.04		 MS850.10		 MS850.15
	 MS850.01		 MS850.05A		 MS850.11A		
	 MS850.02						
VANNAS 12 cm/4 3/4"		VANNAS 16 cm/6 1/4"		MILLESi 16 cm/6 1/4"		JACOBSON 18.5 cm/7 1/4"	

	YASARGIL	Adventitia Blades				
			16 cm/6 1/4"	MS850.16B	MS851.16	MS853.20A
			20 cm/8"	MS850.20	MS851.20	
22.5 cm/9"	MS850.22B	MS851.22				
24.5 cm/9 3/4"			MS851.24			
	YASARGIL	Dissection Blades				
				20 cm/8"	MS854.20	MS855.20
				22.5 cm/9"	MS854.22A	MS855.22



Neurosurgery (Micro Scissors Ring Type, Micro Needle Holders, Perforators)



**CASPAR
NU850.60**
11.5 cm/4½"

**FAHLBUSCH
NU850.50**
16.5 cm/6½"

Micro Needle Holders

Micro Needle Holders



YASARGIL



MN850.20A
20 cm/8"



MN851.20A
20 cm/8"



MN850.22
22.5 cm/9"



MN851.22
22.5 cm/9"



JACOBSON
18 cm/7"



MN852.18A
without catch



JACOBSON
18 cm/7"



MN854.18
with catch



OP546.02
Sadece matkap kolu
Brace only

**HUDSON
OP546.00**
Komple/Complete
V 502.01, V 502.02, V 500.03,
V 500.04, V 500.05, V 500.06,
V 500.07



**HUDSON
OP546.01**
Sadece uzatma parçası
Extension piece only



**CUSHING
OP546.03**
Ø 10 mm

**CUSHING
OP546.04**
Ø 15 mm

**CUSHING
OP546.05**
Ø 14 mm

**McKENZIE
OP546.06**
Ø 13 mm

**HUDSON
OP546.07**
Ø 14 mm

**HUDSON
OP546.08**
Ø 16 mm

**ADSON
OP546.09**
Ø 15 mm

**HUDSON
OP546.10**
Ø 22 mm

**HUDSON
OP546.11**
Ø 9 mm

OP546.12
Ø 2 mm