

## Otology (Micro Ear Forceps)

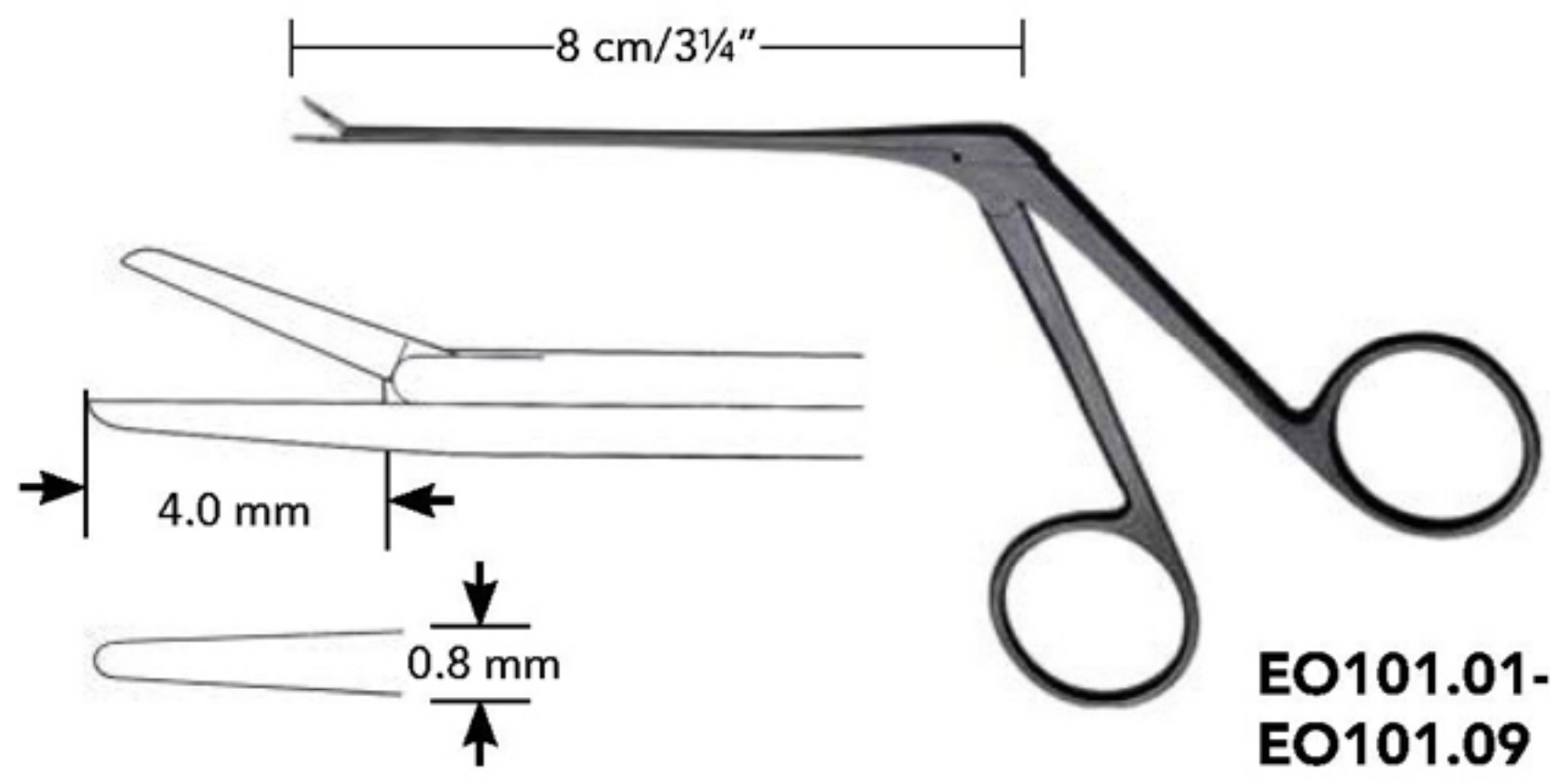

**EO101.01-  
EO101.09**

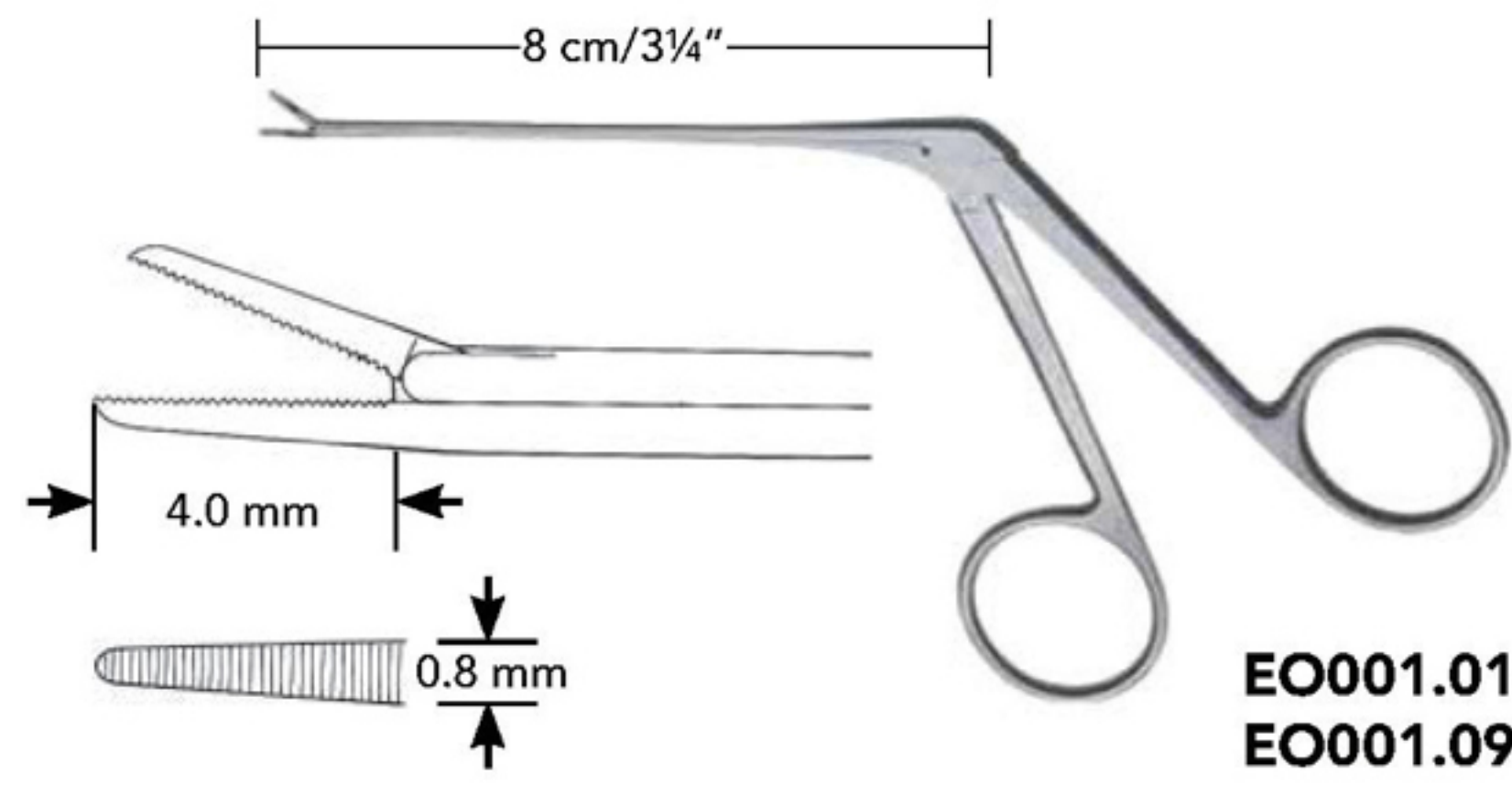

**EO001.01-  
EO001.09**

straight smooth



**EO001.01  
EO101.01**

straight serrated

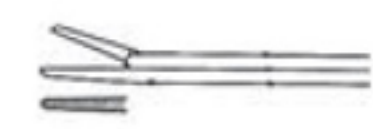

**EO001.06  
EO101.06**

bent upwards serrated



**EO001.07  
EO101.07**

right serrated



**EO001.08  
EO101.08**

left serrated

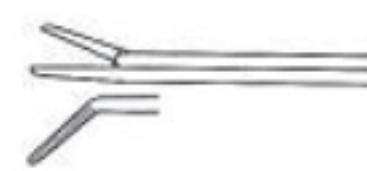

**EO001.09  
EO101.09**

Black Coated

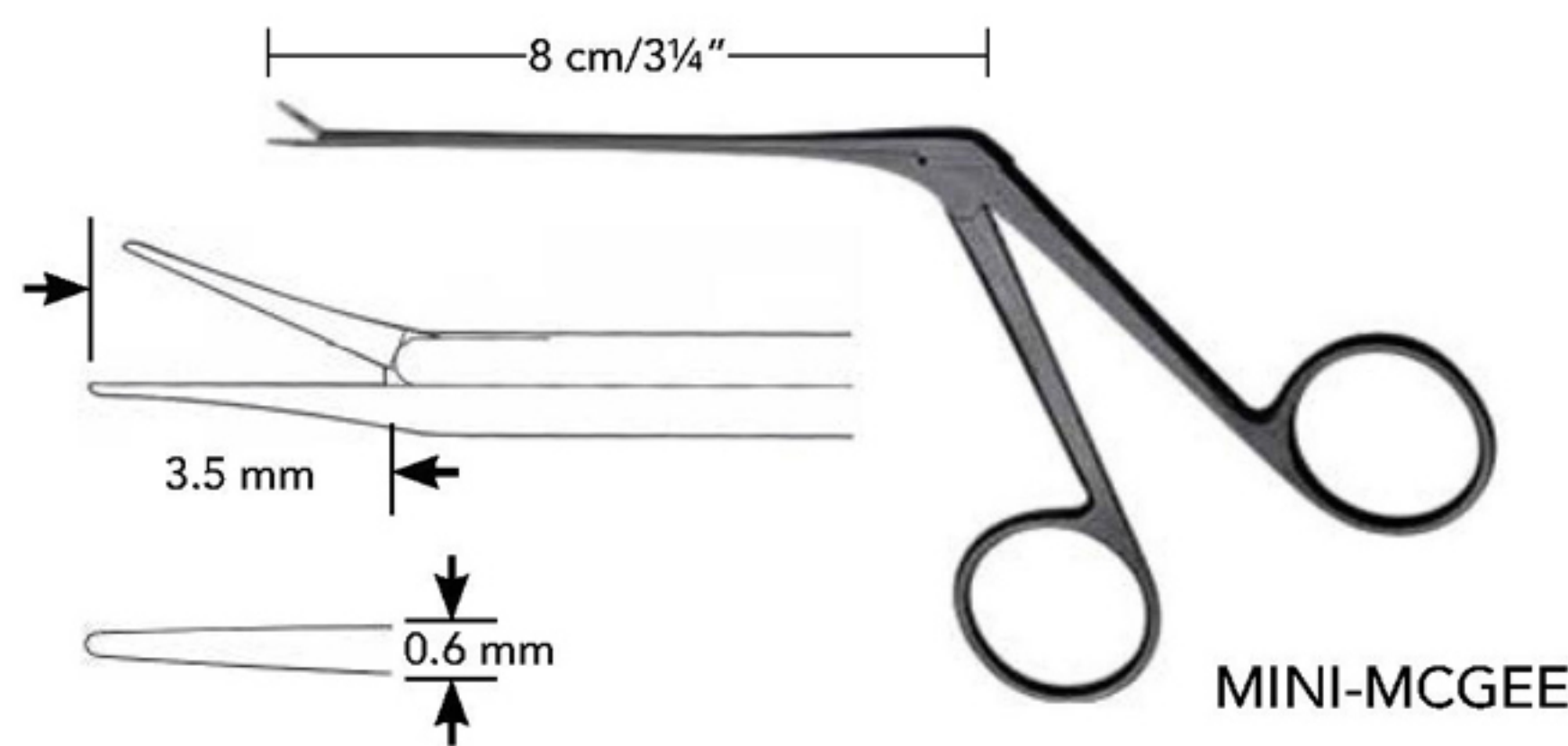

**MINI-MCGEE**

straight smooth



**EO101.11**

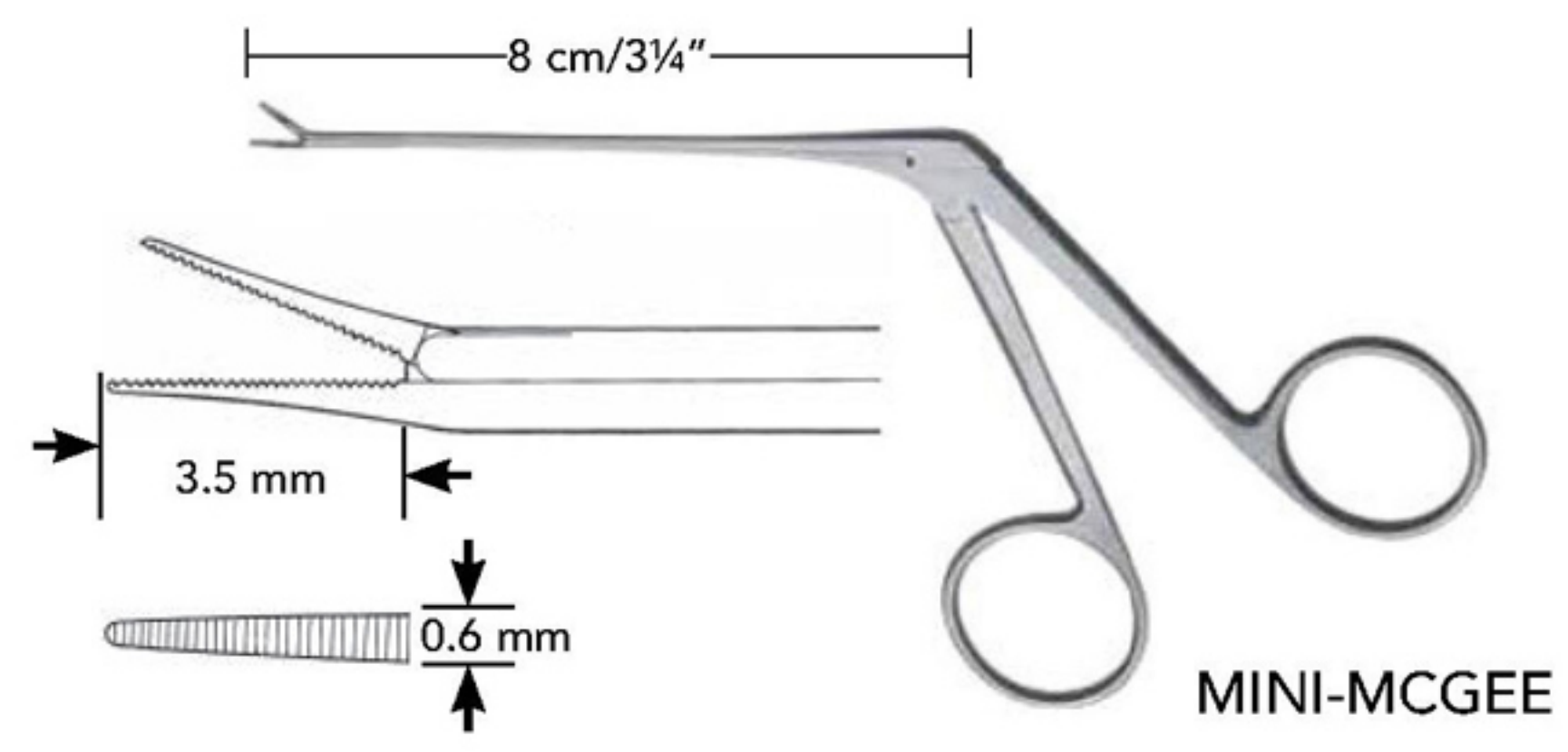

**MINI-MCGEE**

straight serrated



**EO001.16**

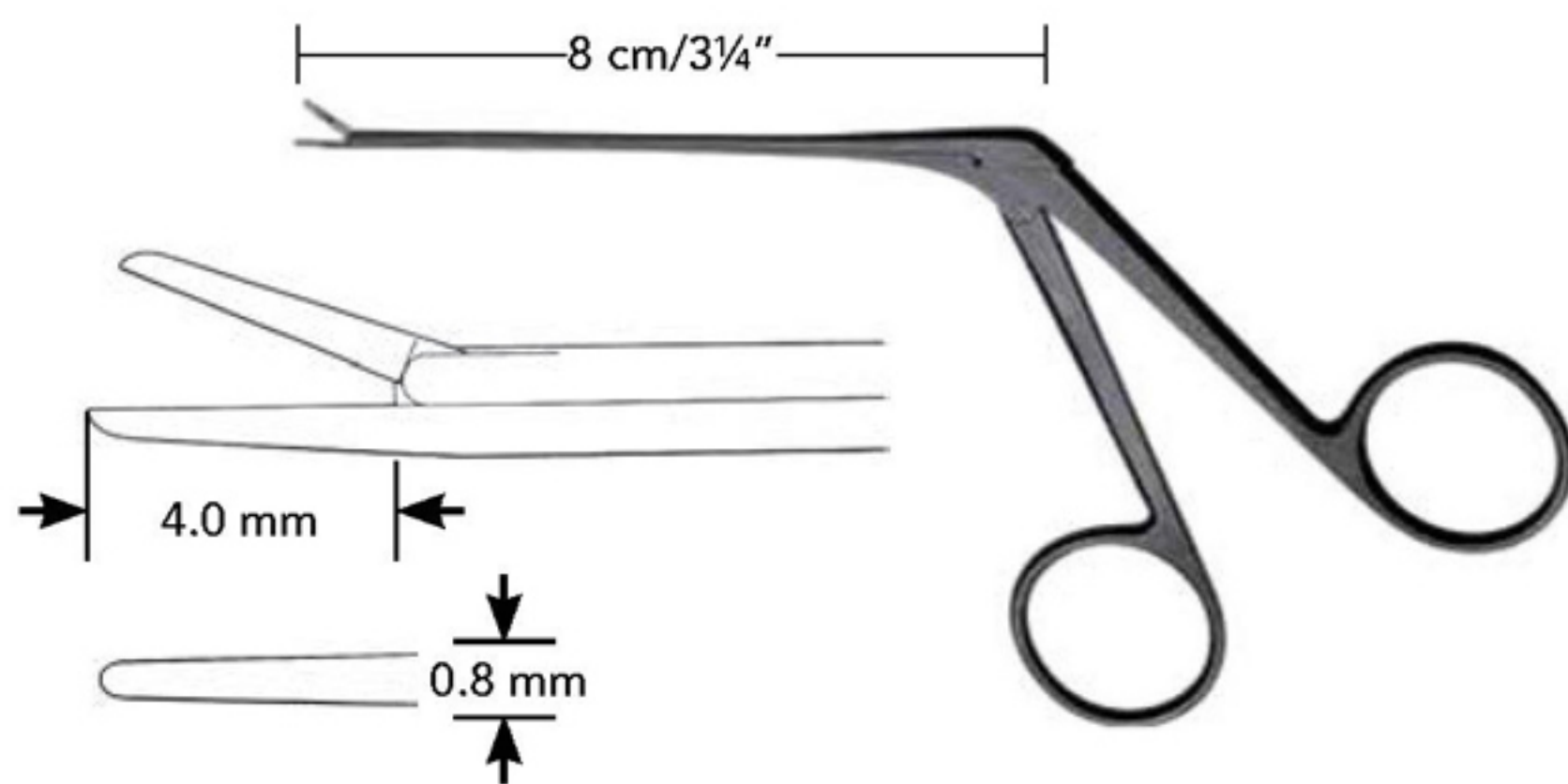

straight smooth



**EO101.21**

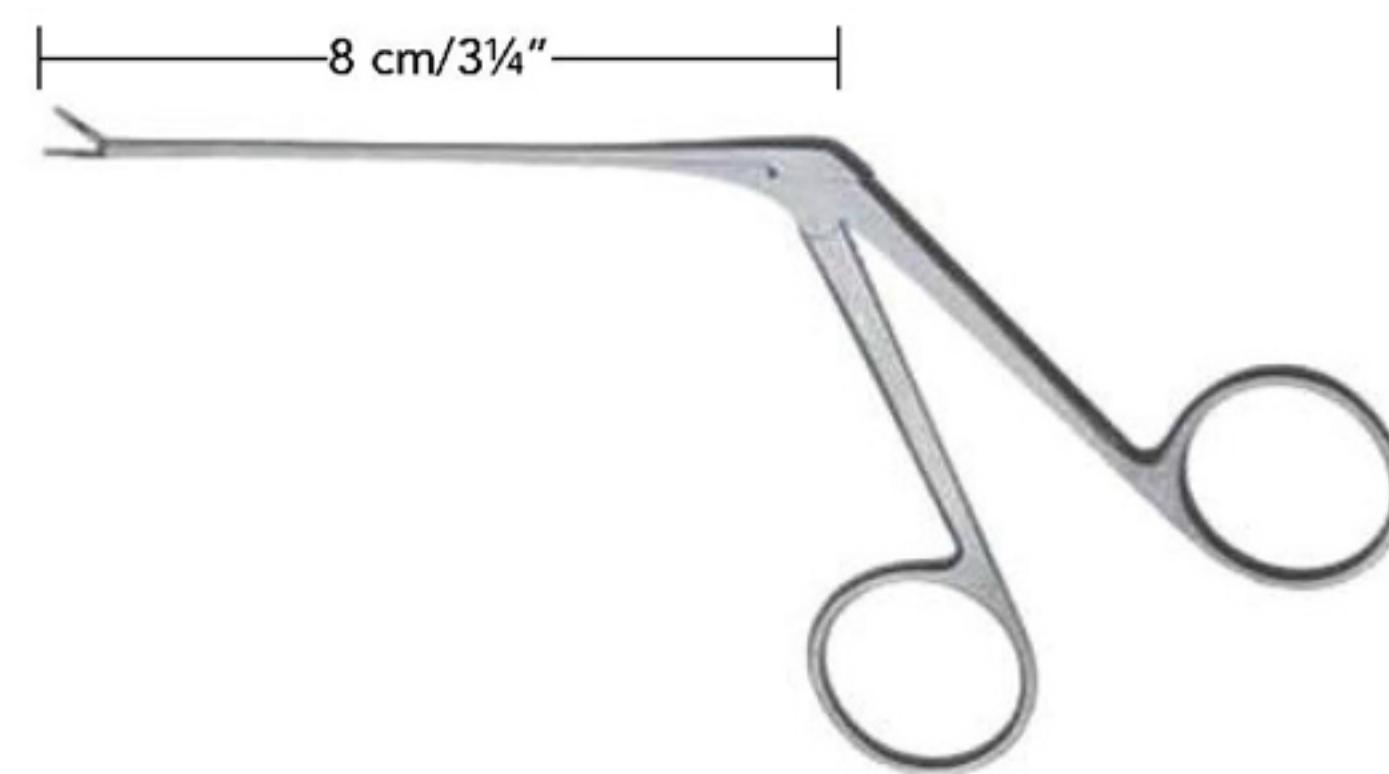

straight smooth



**EO001.21**

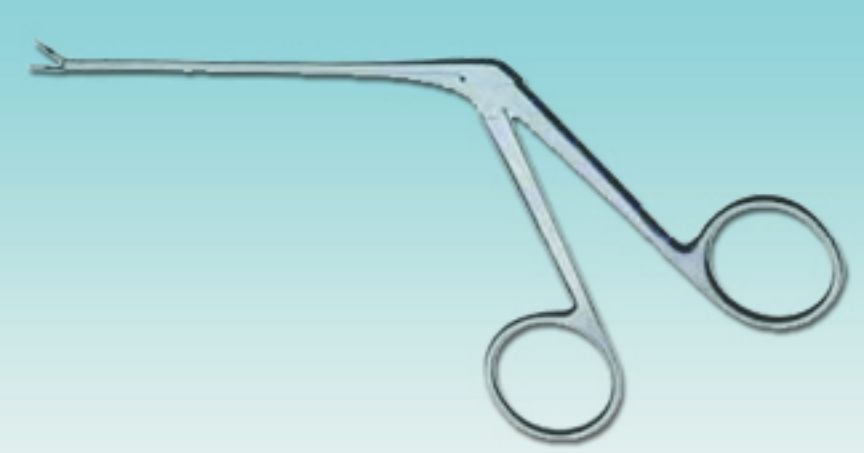

## Otology (Micro Ear Forceps)

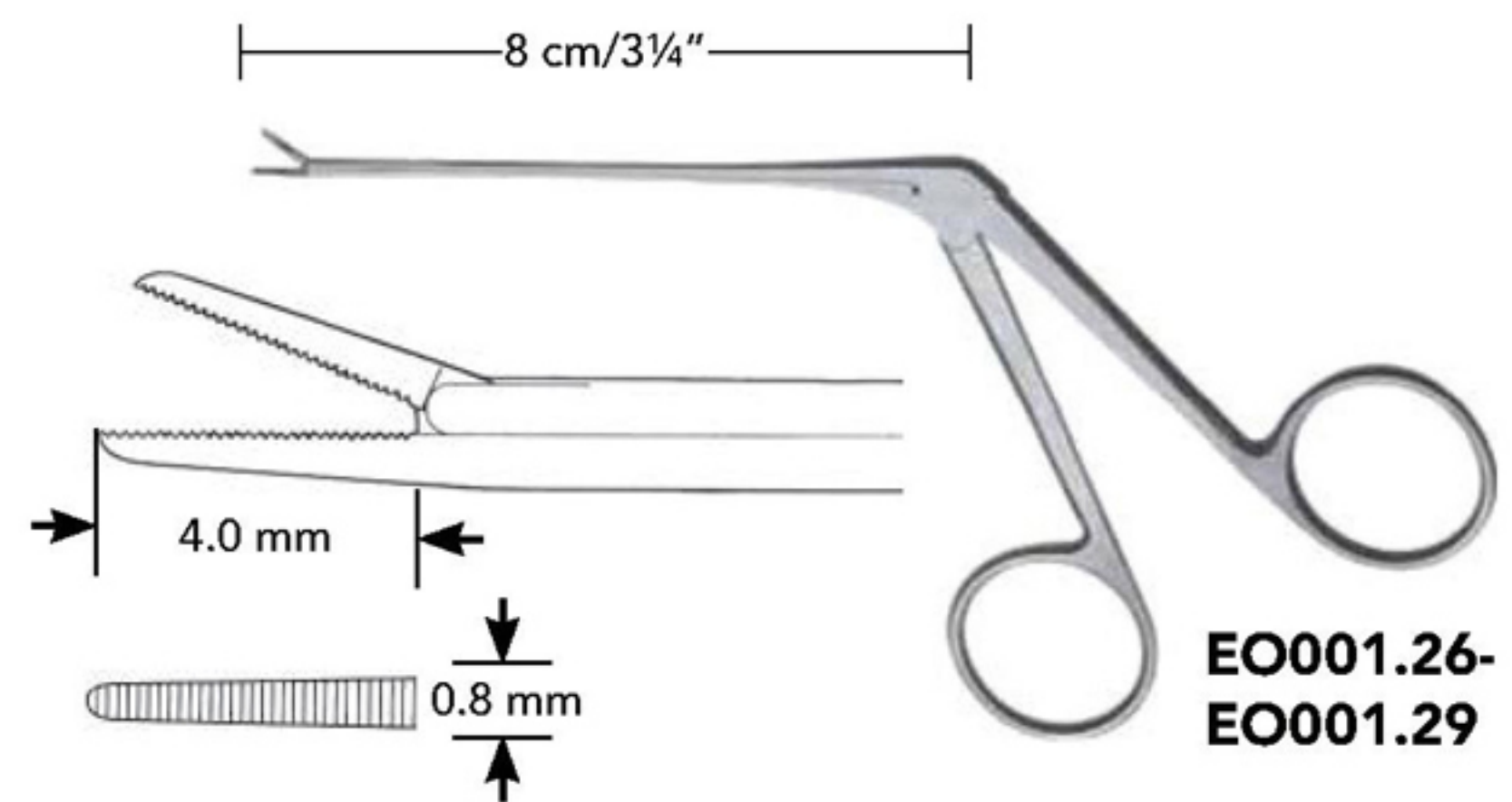
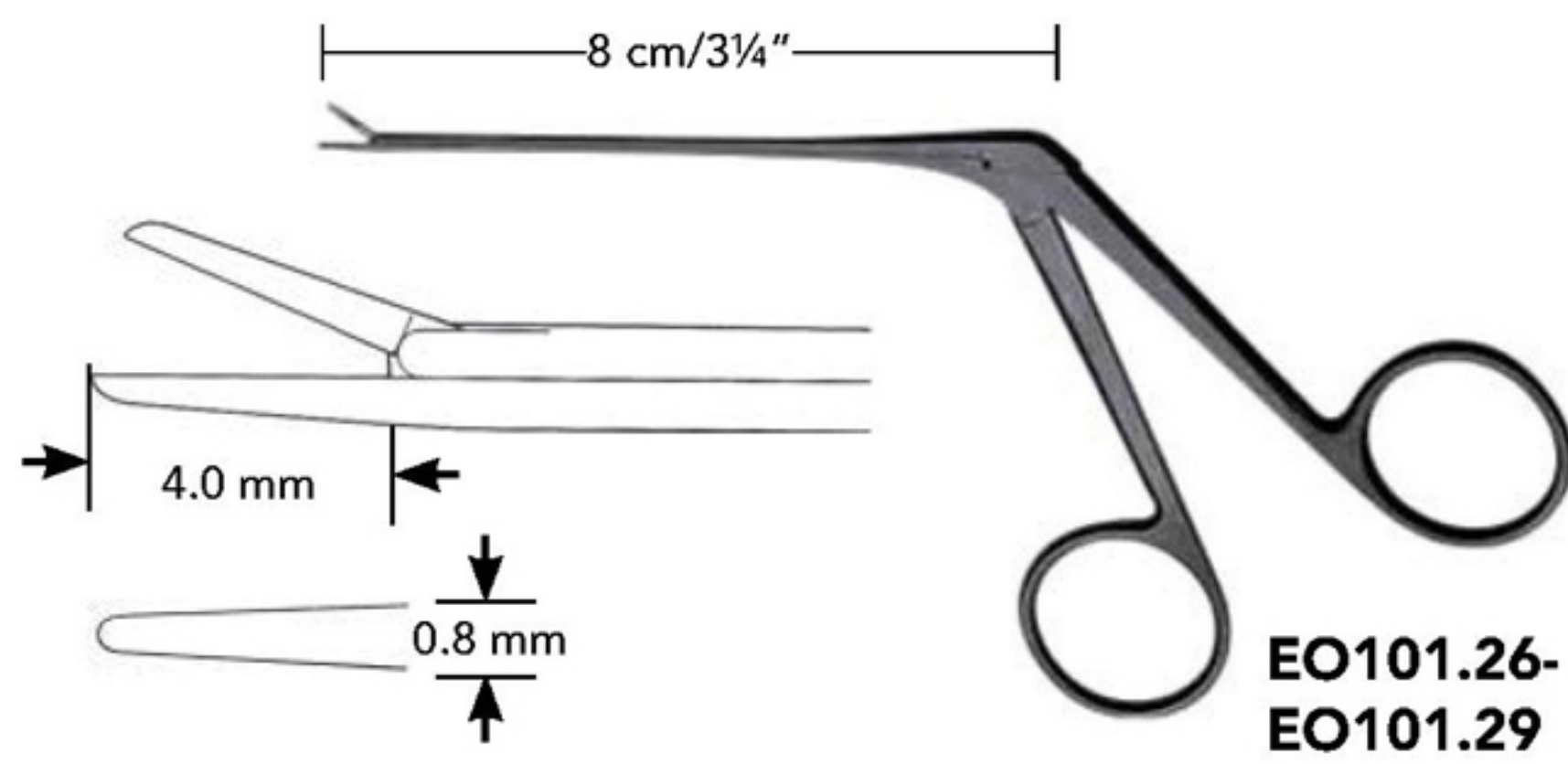

straight smooth

upwards serrated

right serrated

left serrated



**EO.001.26  
EO101.26**

**EO.001.27  
EO101.27**

**EO.001.28  
EO.101.28**

**EO001.29  
EO101.29**

Black Coated

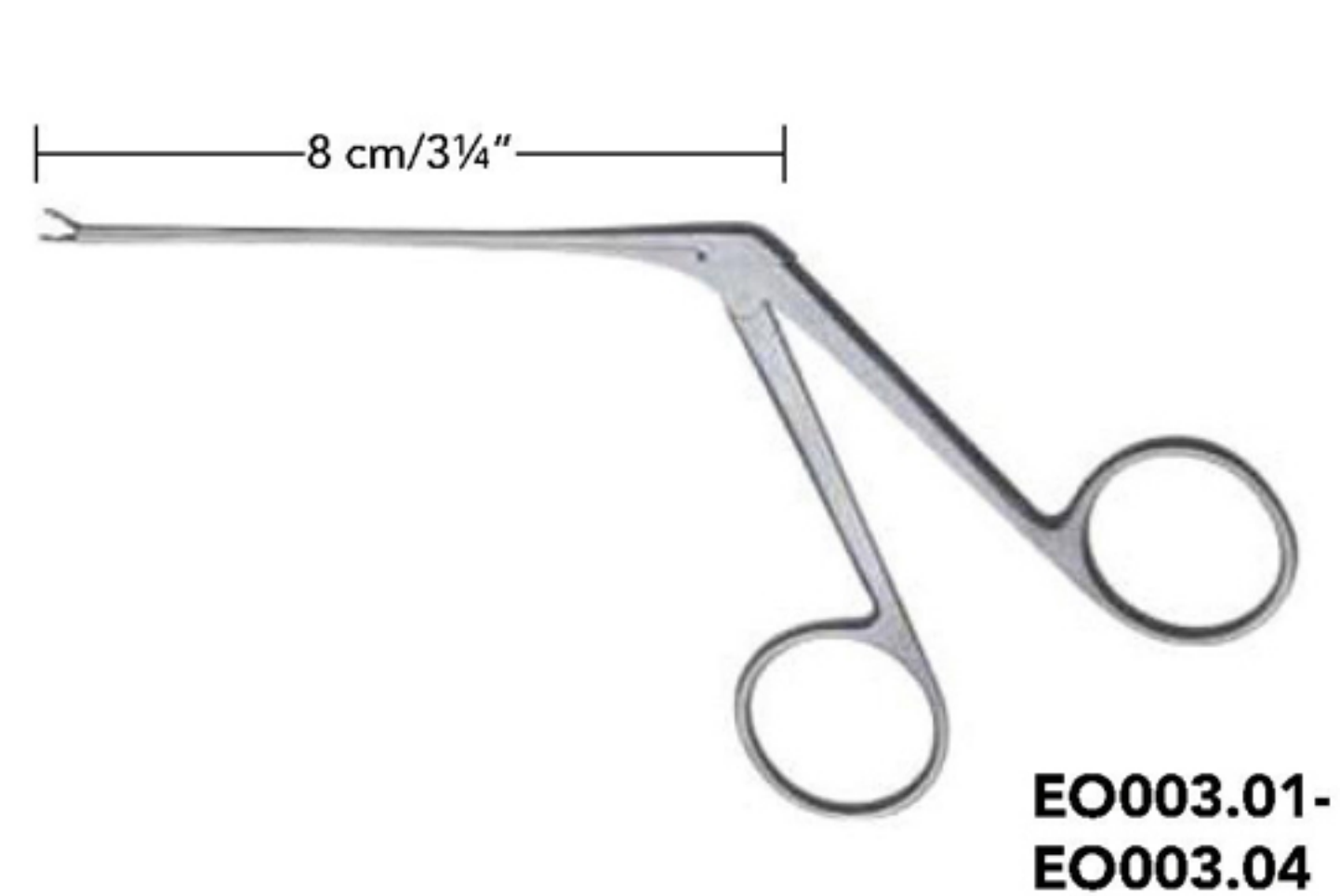
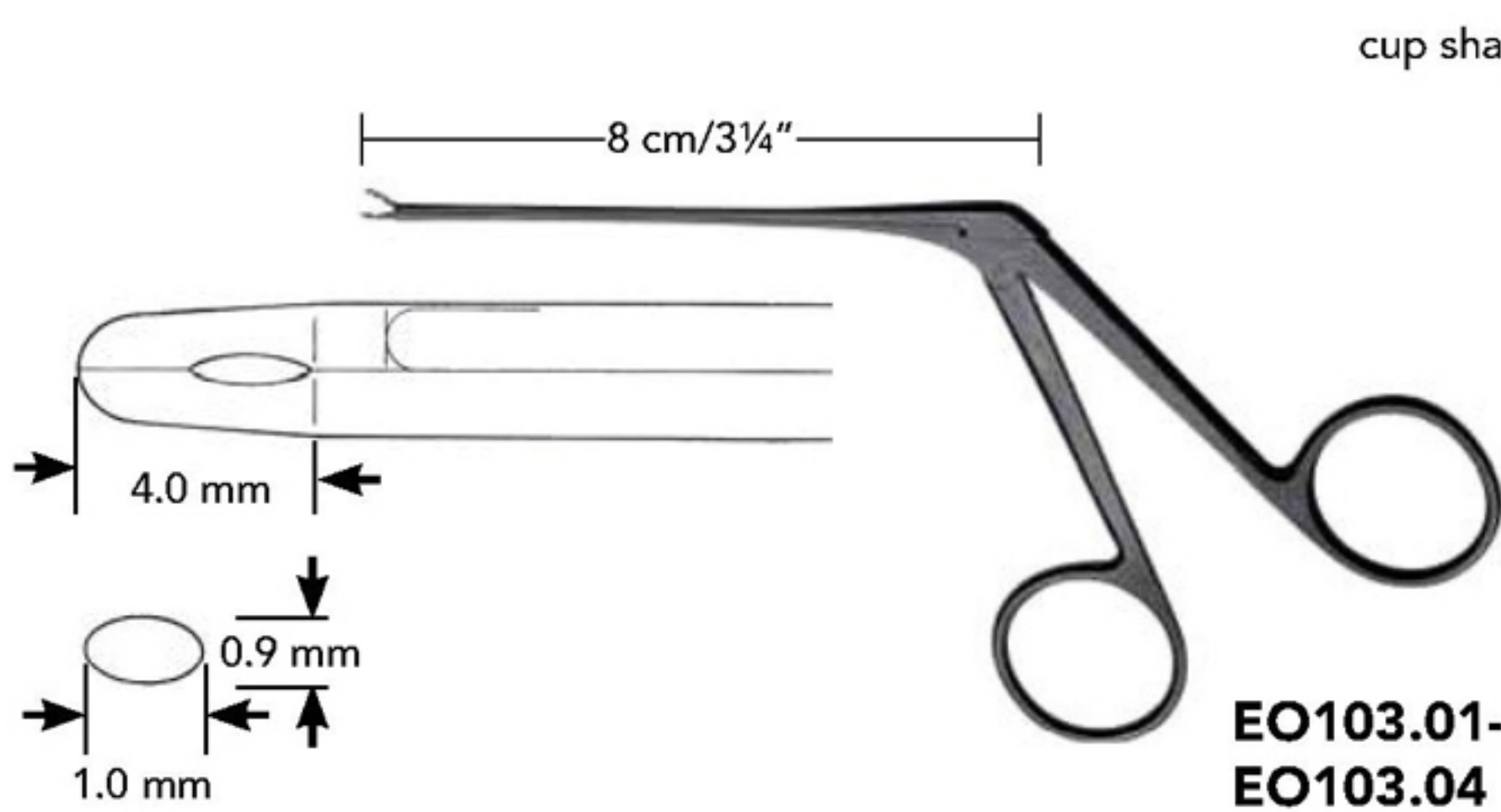

cup shaped

straight

bent upwards

right

left

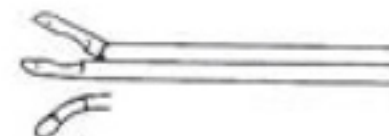
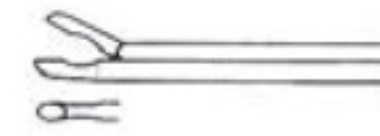

**EO003.01  
EO103.01**

**EO.003.02  
EO103.02**

**EO.003.03  
EO103.03**

**EO.003.04  
EO103.04**

Black Coated

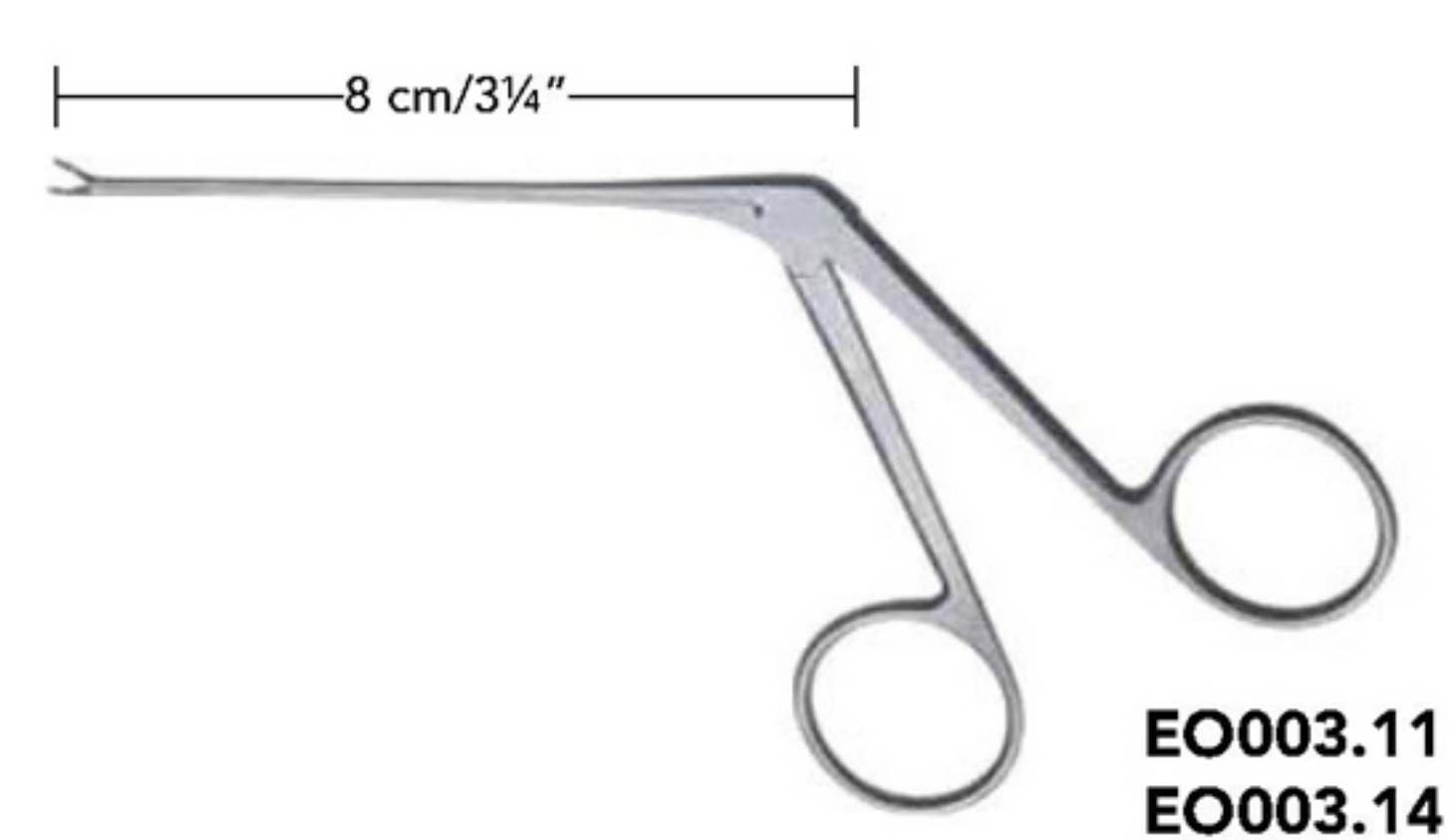
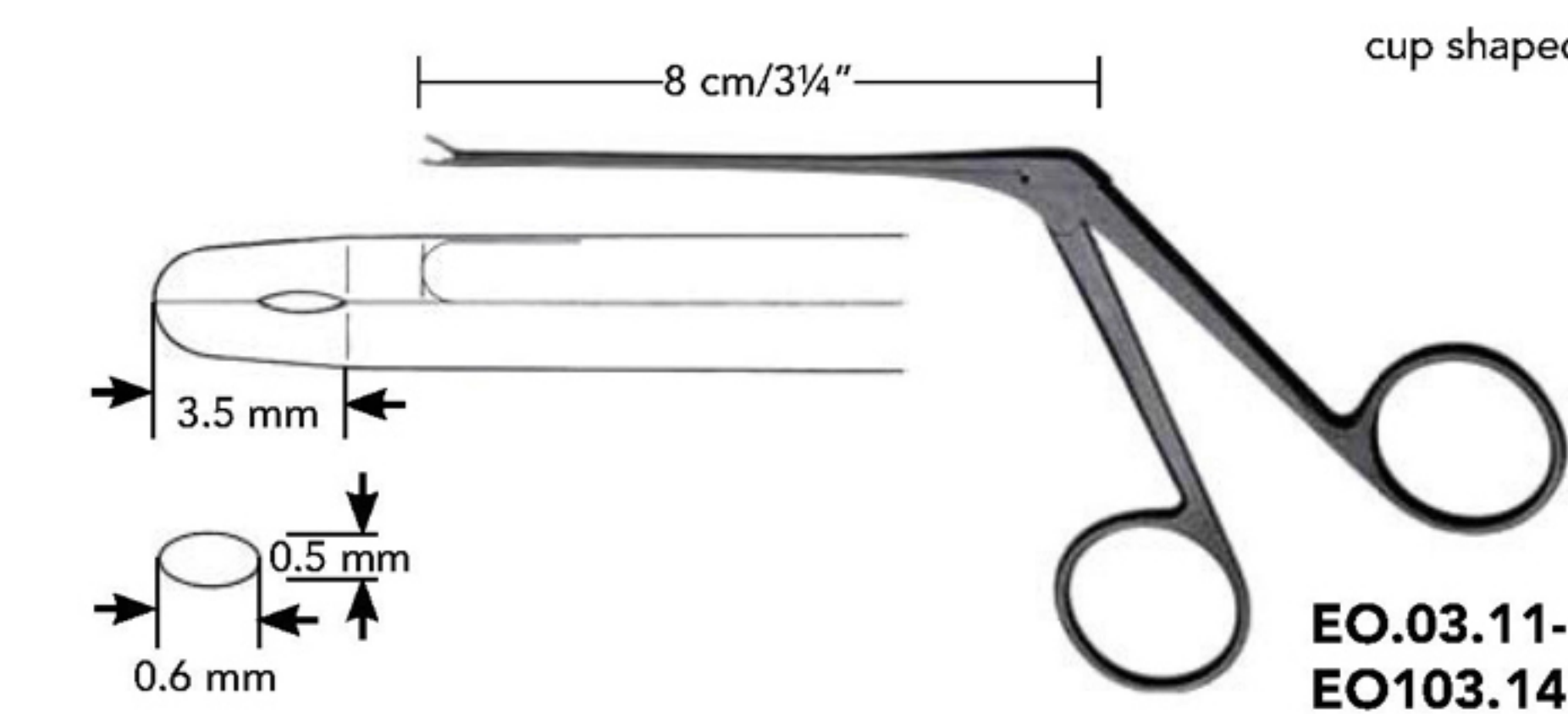

cup shaped

straight

bent upwards

right

left

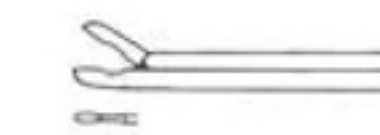

**EO003.11  
EO103.11**

**EO003.12  
EO103.12**

**EO003.13  
EO103.13**

**EO003.14  
EO103.14**

Black Coated

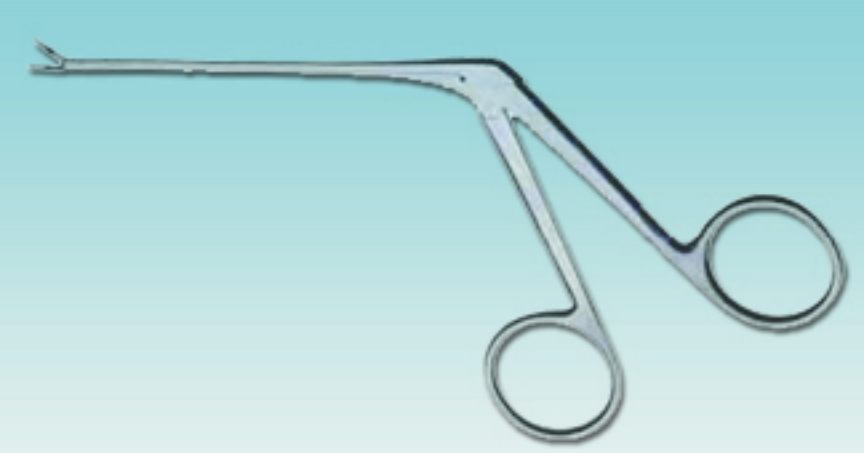

## Otology (Micro Ear Forceps)

### Wire bending forceps

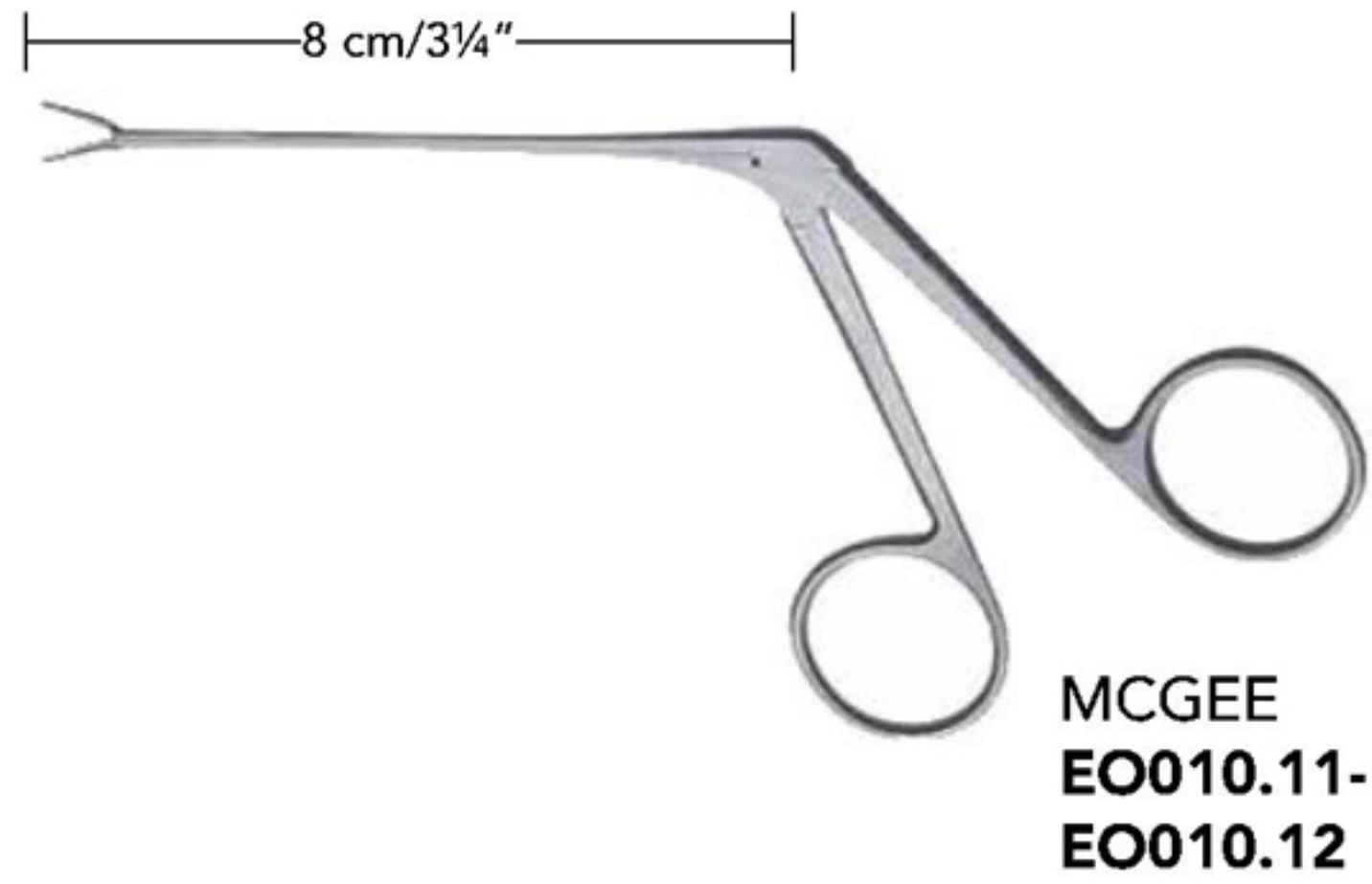
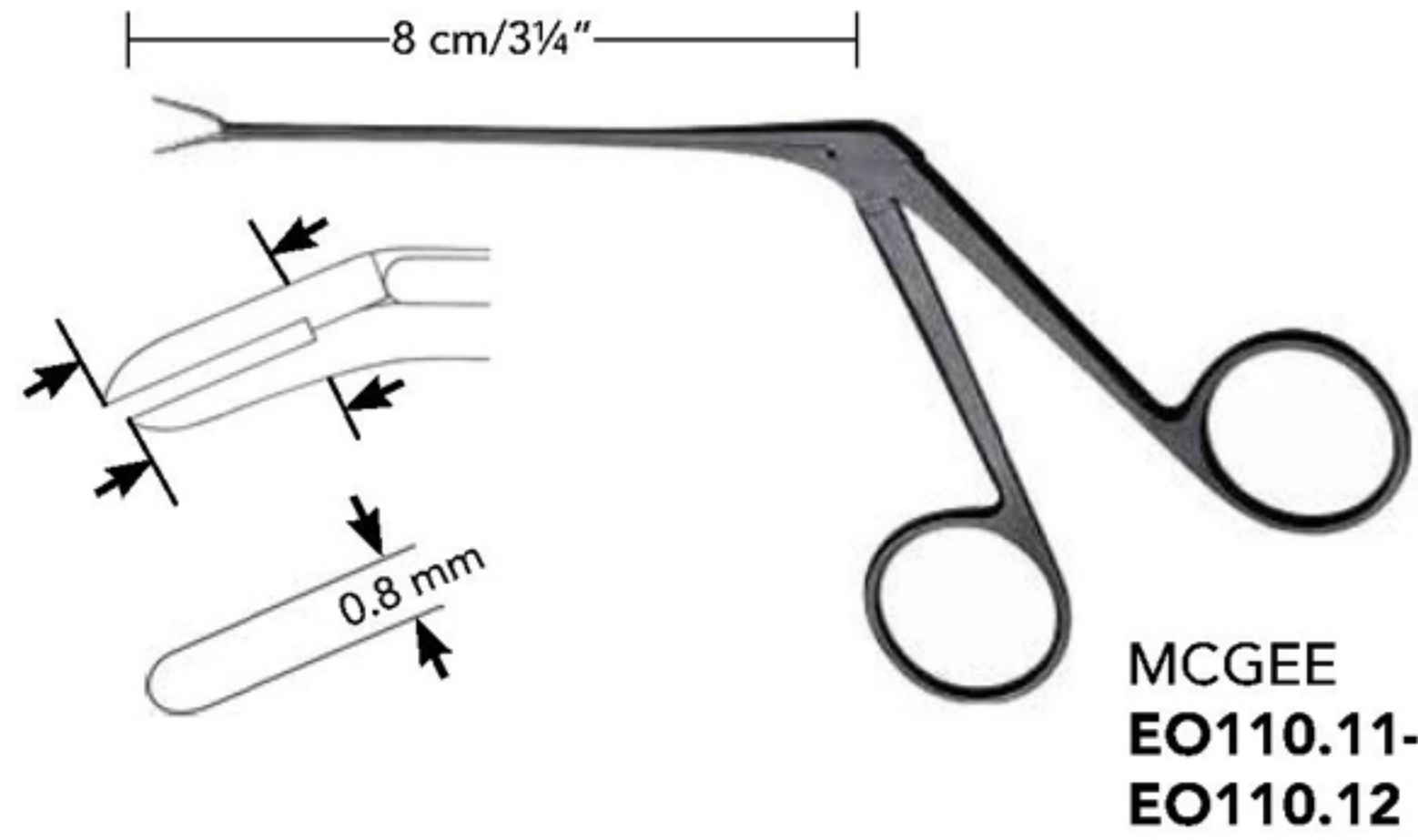

angled downward

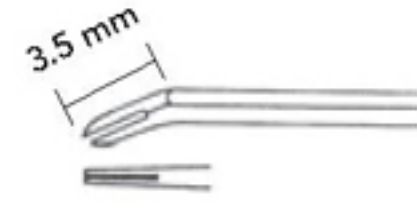

0.8 x 3.5 mm  
EO010.11  
EO110.11

angled downward

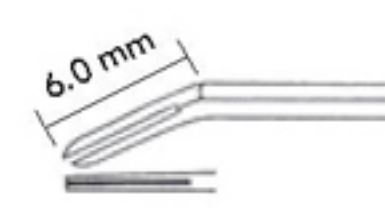

0.8 x 3.5 mm  
EO010.12  
EO110.12 Black Coated

### Malleus Nipper

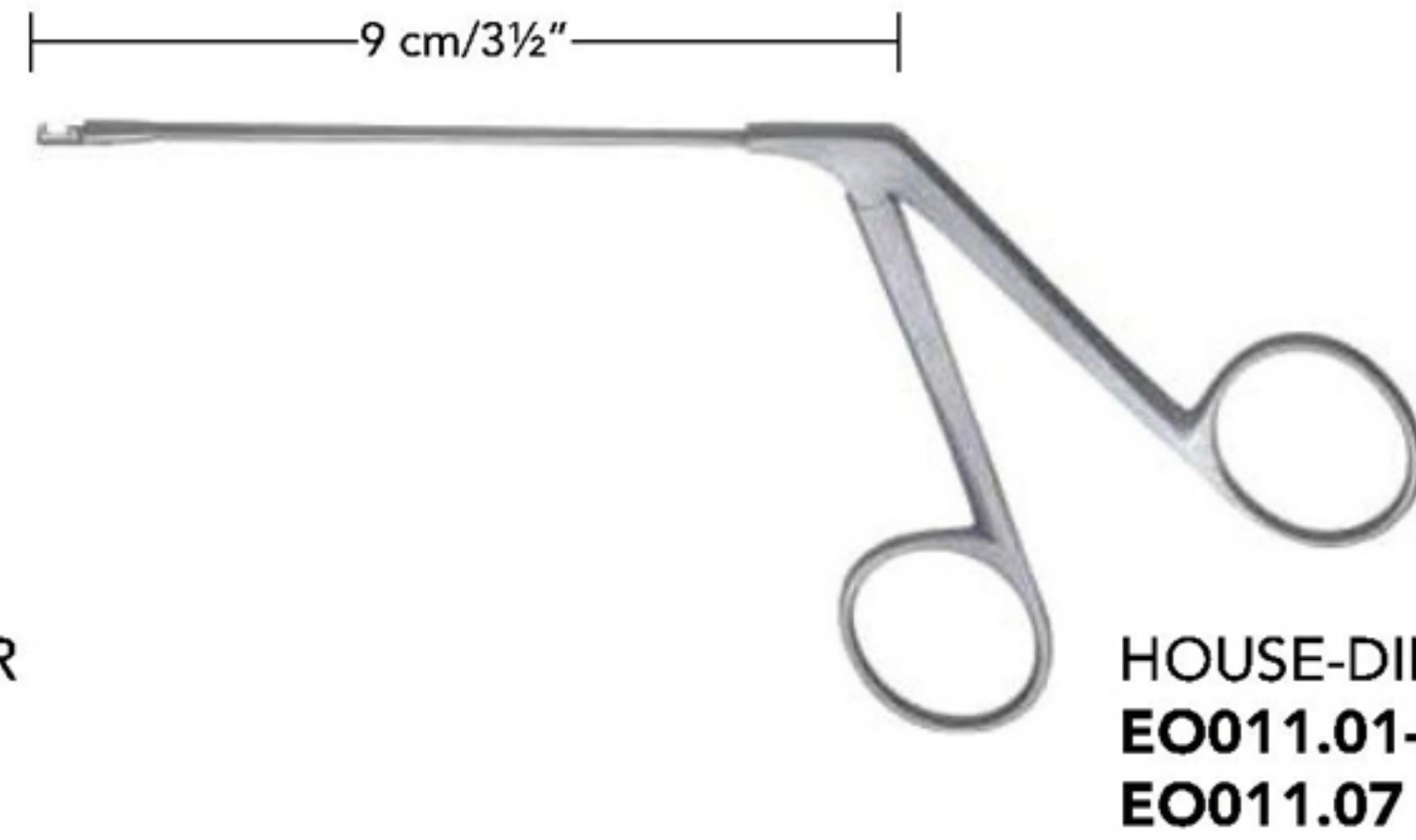
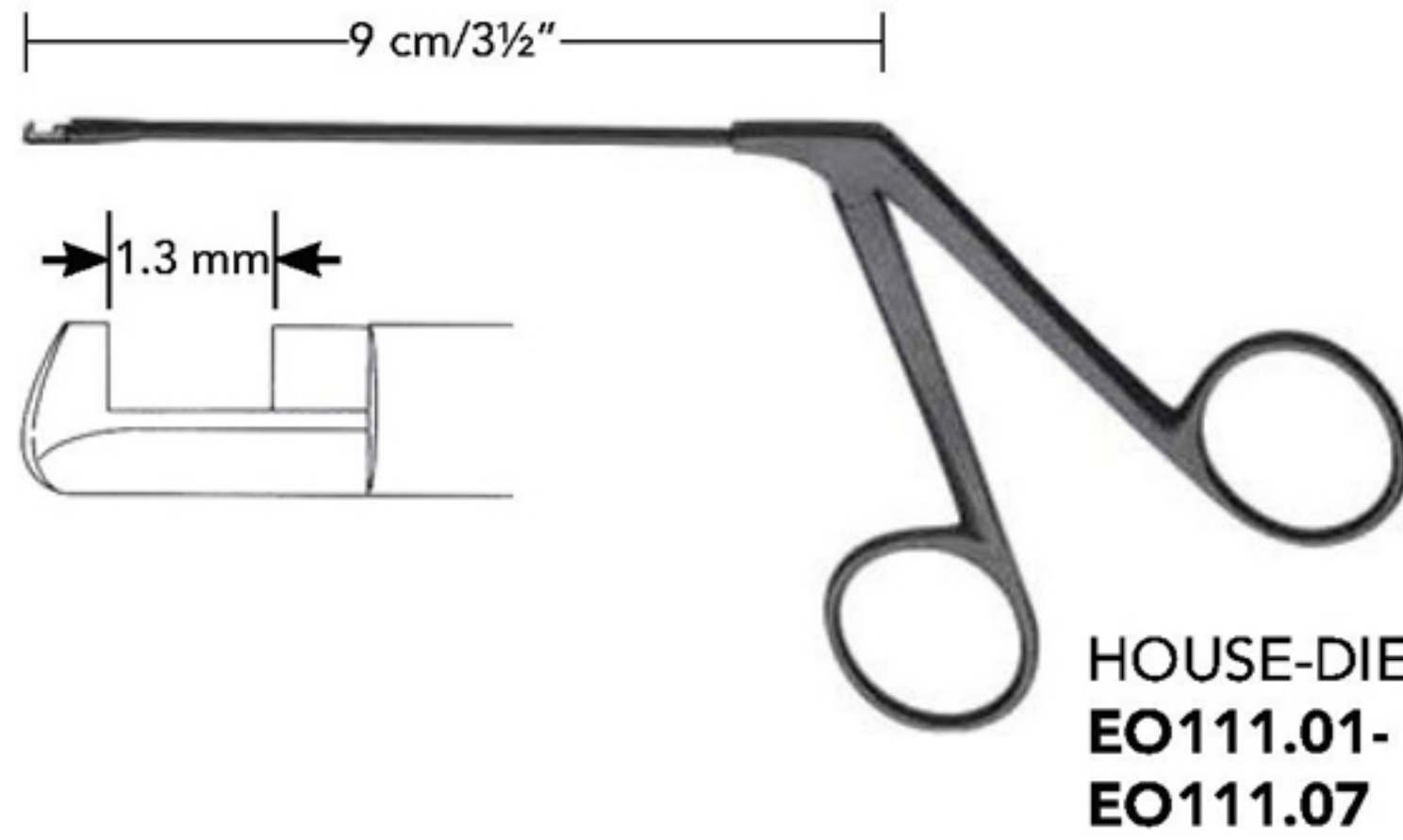

up cutting

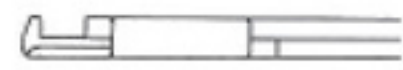

EO011.01  
EO111.01

down cutting



EO011.02  
EO111.02

right cutting



EO011.06  
EO111.06

left cutting



EO011.07  
EO111.07

Black Coated

### Introducing Forceps, for teflon prosthesis

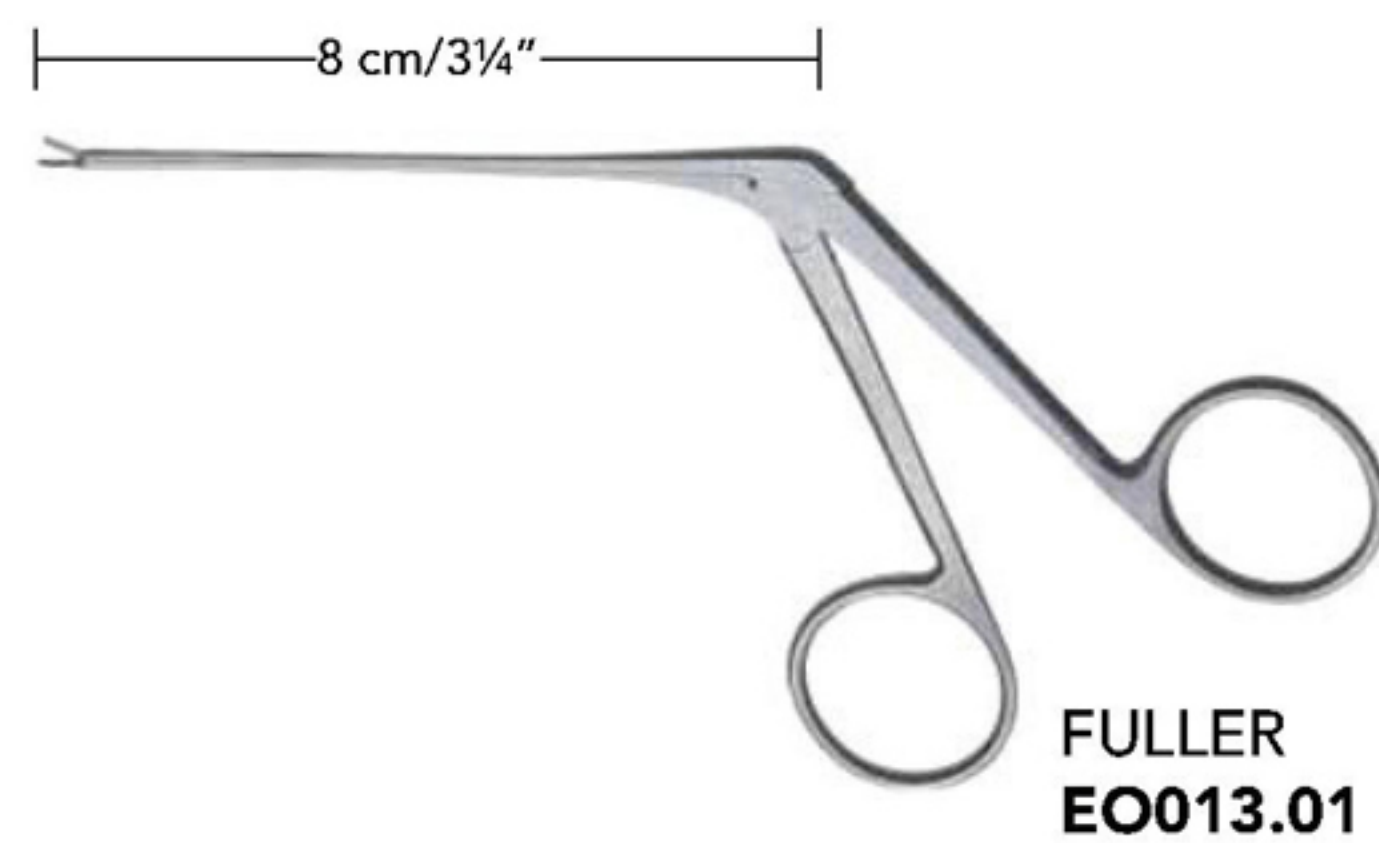

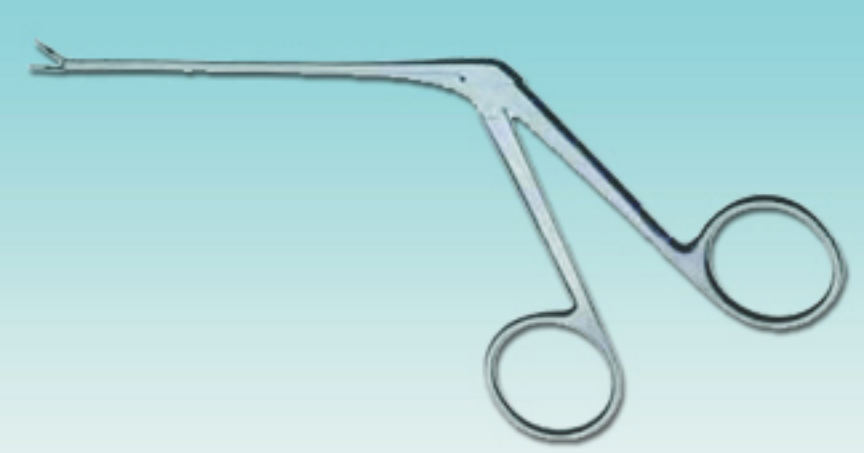

## Otology (Micro Ear Forceps)

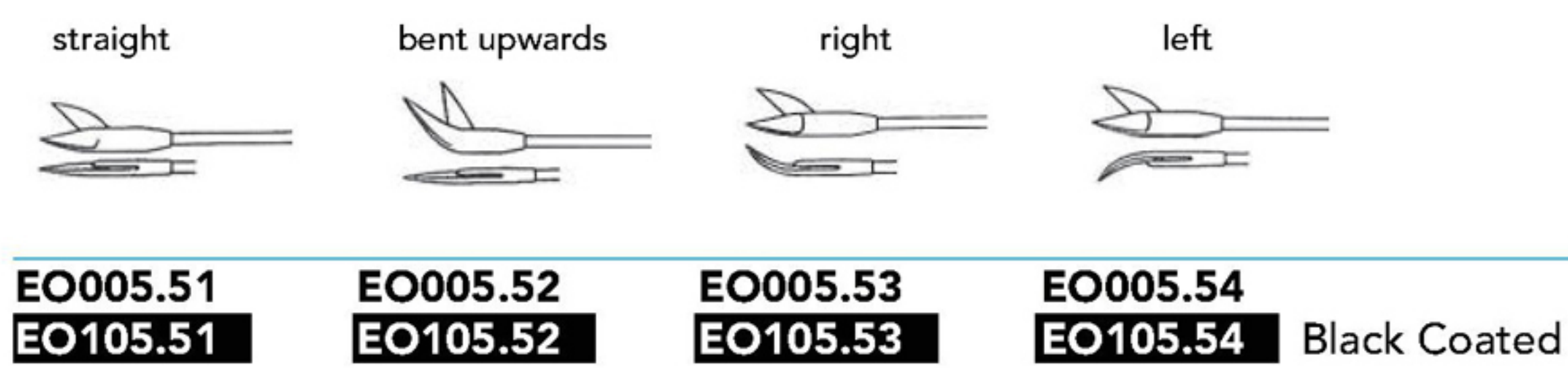
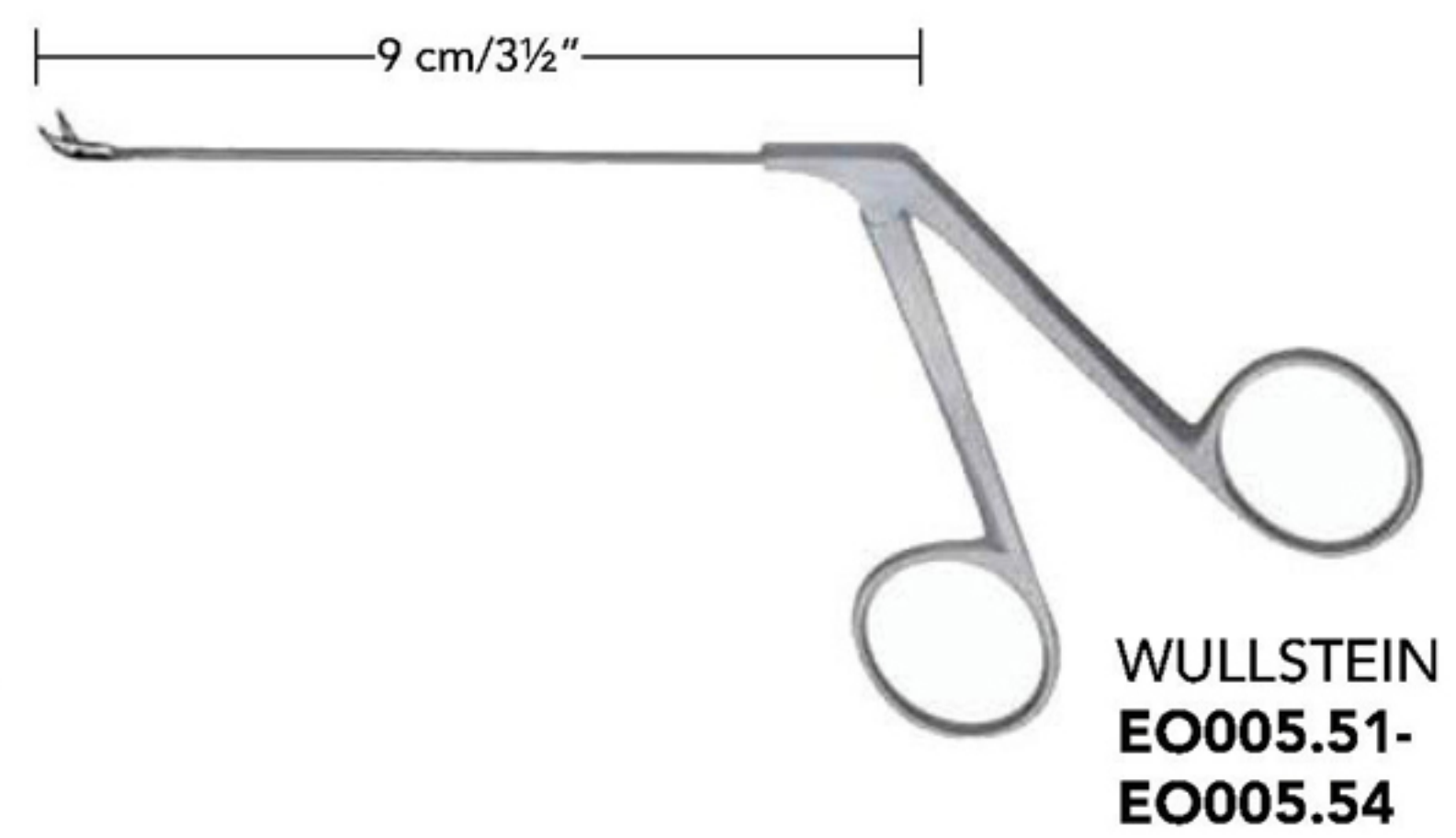
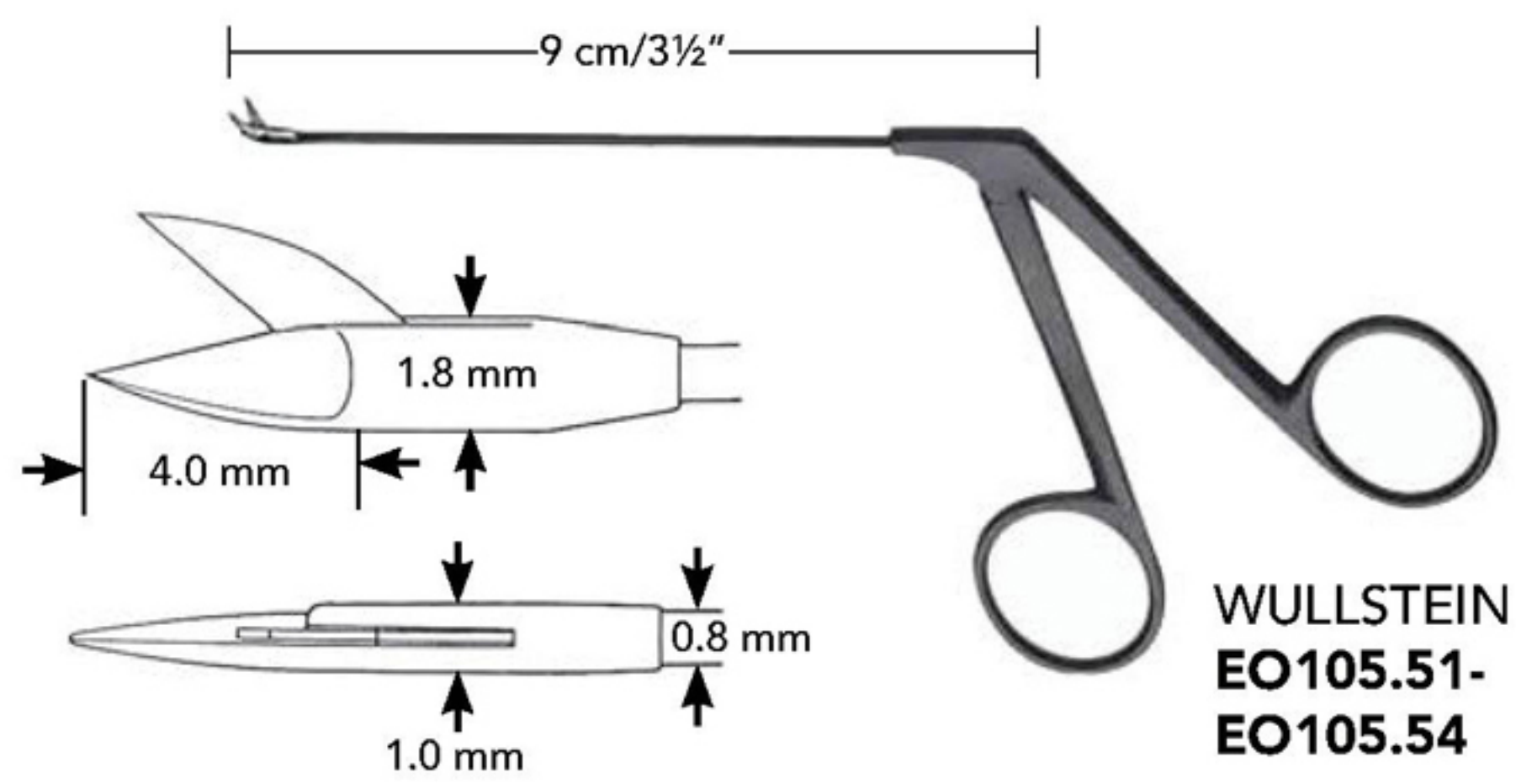
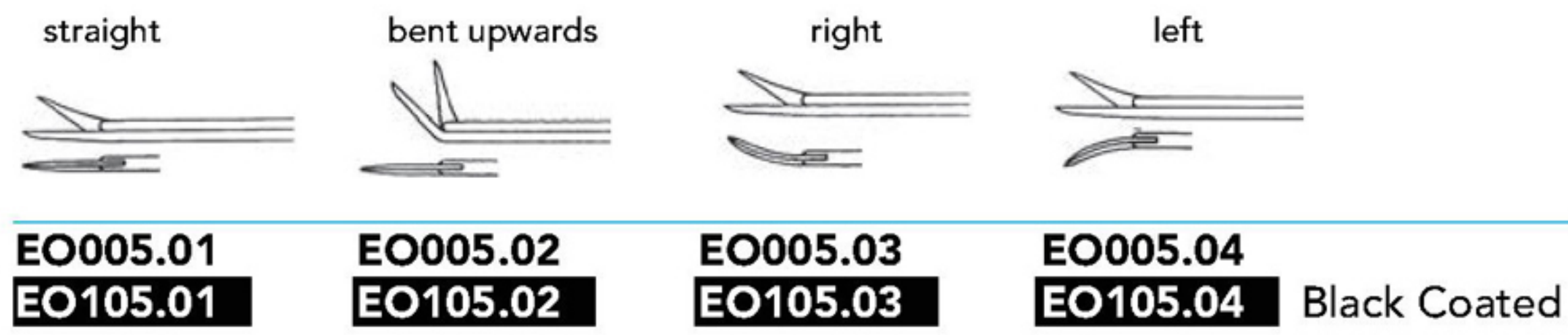
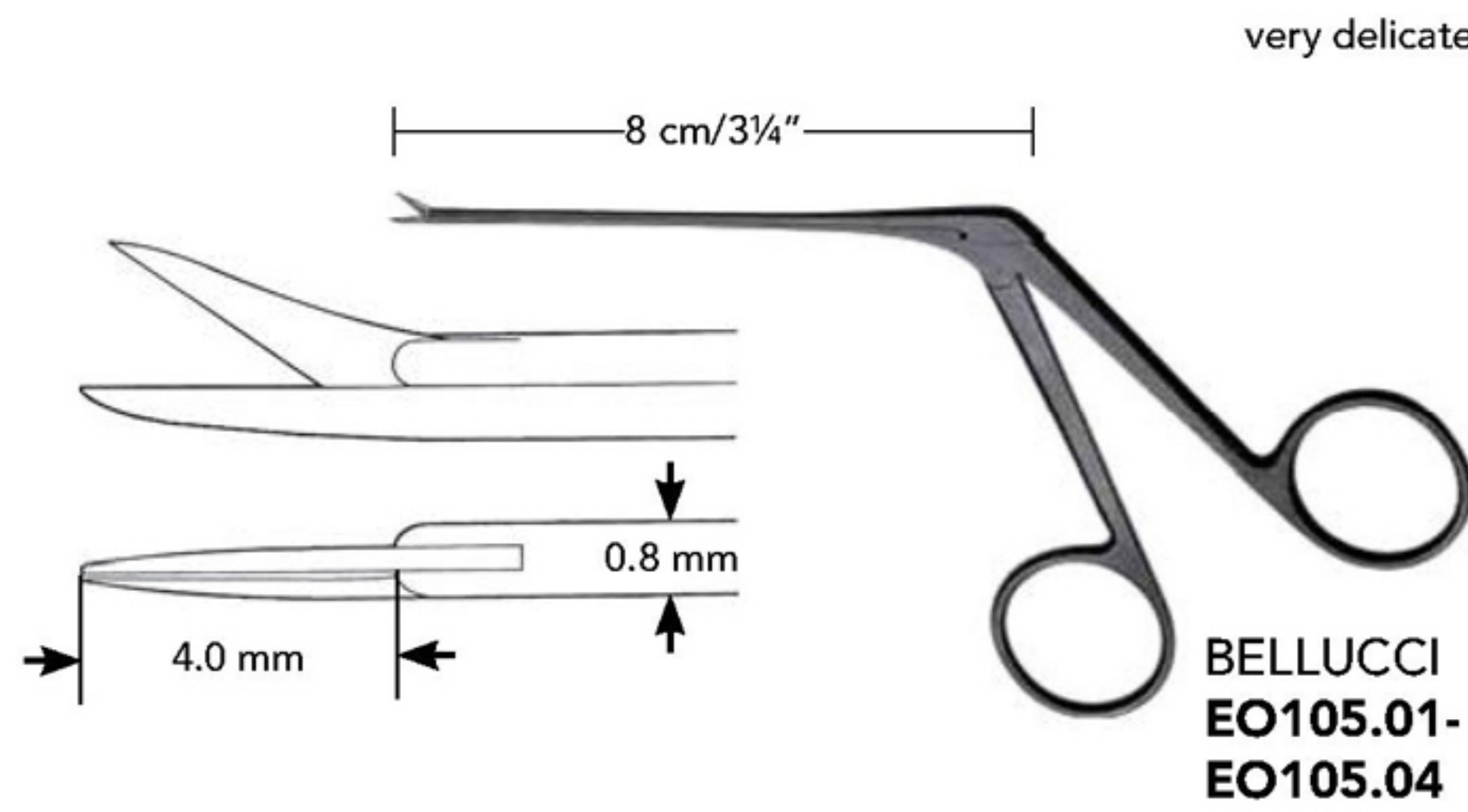

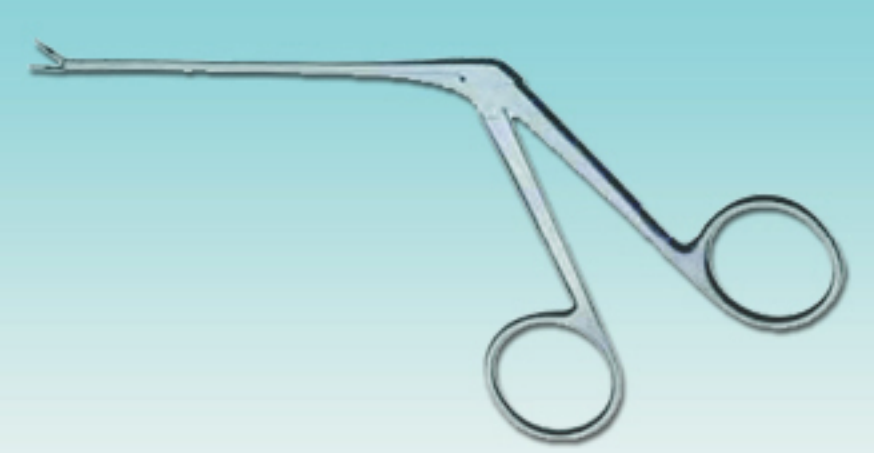

## Otology (Micro Ear Knives & Hooks)

Sickle Knife



SCHUKNECHT  
EO020.06  
14.5 cm/5¾"

Sickle Knife



WULLSTEIN  
EO020.11  
15.5 cm/6¼"

Mucosa Knife



TABB  
EO020.16  
15.5 cm/6¼"

Flap Knife



PLESTER  
EO020.21  
15 cm/6"



ROSEN  
15 cm/6"

Ø 3.0 mm



EO022.01  
Fig. 1

Ø 2.8 mm



EO022.02  
Fig. 2

Ø 2.6 mm



EO022.03  
Fig. 3

Ø 2.0 mm



EO022.04  
Fig. 4

Ø 1.6 mm



EO022.05  
Fig. 1

Ø 1.4 mm



EO022.06  
Fig. 2

Ø 1.0 mm



EO022.07  
Fig. 3



16 cm/6¼"

BARBARA  
EO024.01



BARBARA  
EO024.02



BARBARA  
EO024.03



ROSEN  
EO024.04



bent upwards    angled



0.3 mm EO025.01    EO025.06  
0.6 mm EO025.02    EO025.07  
1.0 mm EO025.03    EO025.08

bent upwards    angled



0.3 mm EO024.06  
0.6 mm EO024.07  
1.0 mm EO024.08



hook  
25°  
45°  
90°  
0.3 mm EO024.11    EO024.21  
0.6 mm EO024.12    EO024.22  
1.0 mm EO024.13    EO024.23  
1.2 mm EO024.14    EO024.24  
1.5 mm EO024.15    EO024.25  
2.0 mm EO024.16    EO024.26  
2.5 mm EO024.17    EO024.27



0.5 mm EO024.31  
1.0 mm EO024.32



15.5 cm/6"

hook  
MC GEE    MC GEE  
0.5 mm EO027.01    EO027.11  
1.0 mm EO027.02    EO027.12

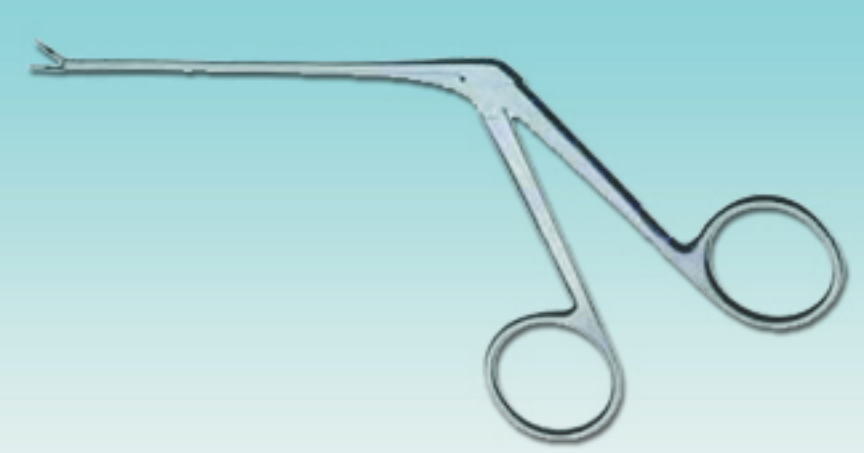



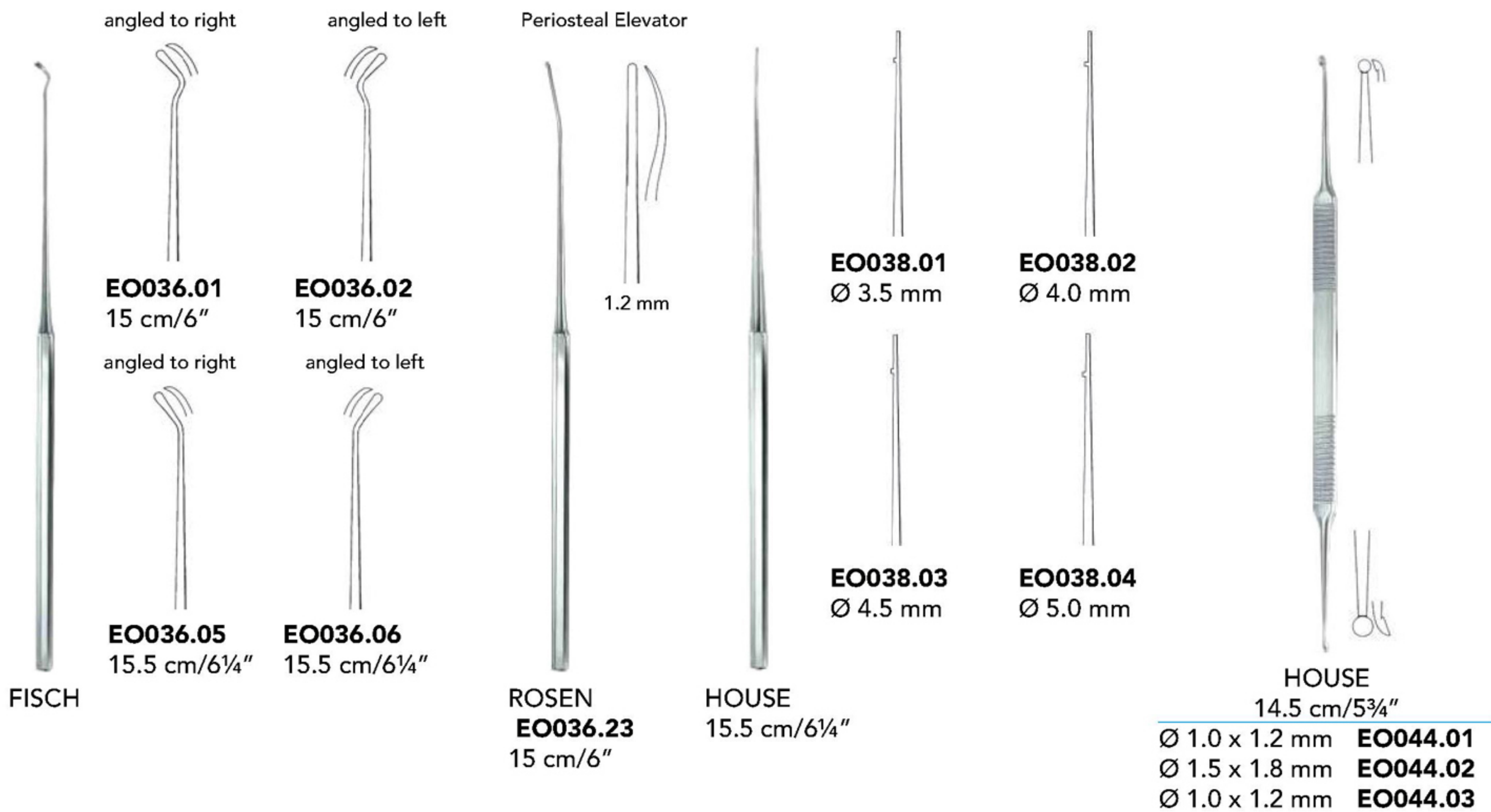
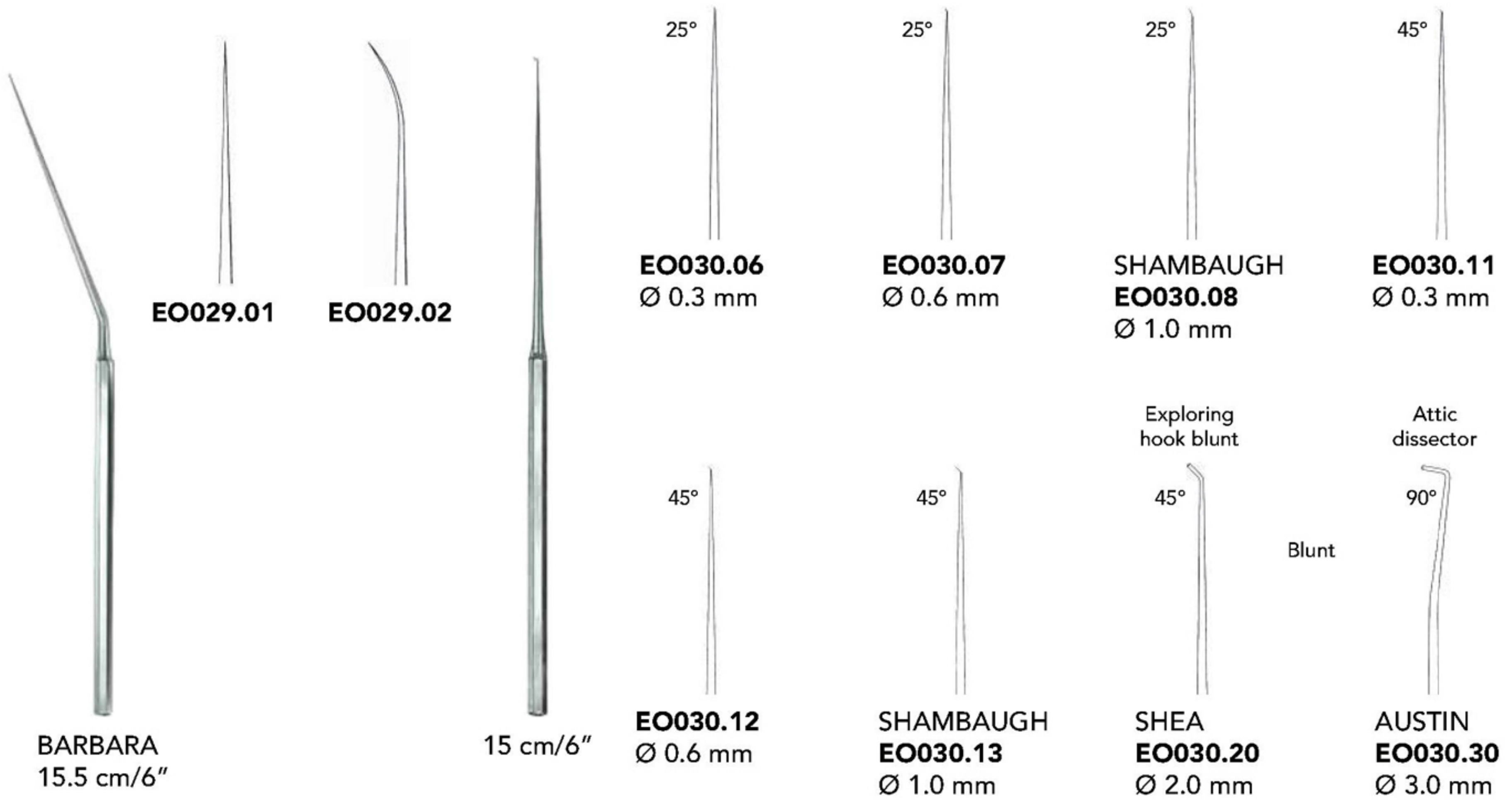

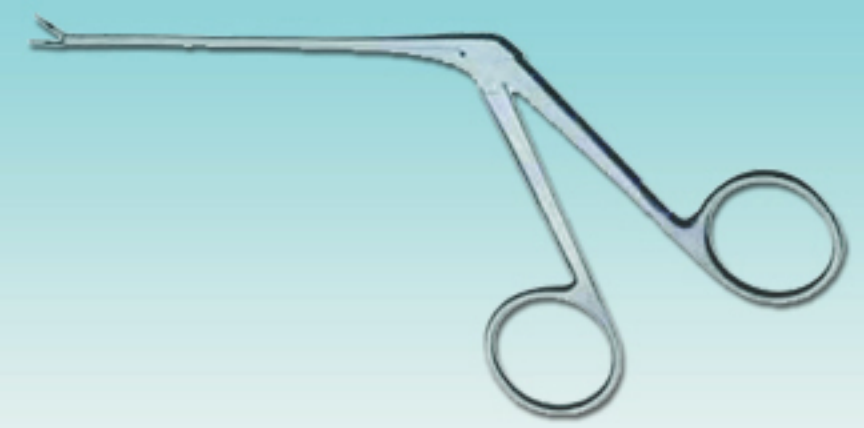

















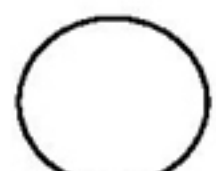

## Otology (Micro Ear Forceps, Needles & Curettes)





## Otology (Micro Specula)

				
	<b>EO112.10</b> Ø 3 mm Fig. 0	<b>EO112.13</b> Ø 6 mm Fig. 3	<b>EO.118.11</b> Ø 4 mm Fig. 1	<b>EO.118.13</b> Ø 6 mm Fig. 3
				
	<b>EO112.11</b> Ø 4 mm Fig. 1	<b>EO112.14</b> Ø 7.5 mm Fig. 4	<b>EO118.12</b> Ø 5 mm Fig. 2	<b>EO118.14</b> Ø 7.5 mm Fig. 4
				
<b>HARTMANN</b> 3.6 cm/1½"	<b>EO112.12</b> Ø 5 mm Fig. 2		<b>TOYNBEE</b> 3.6 cm/1½"	
Set for Children Fig. 0 - 2 <b>EO112.03</b>			Set for Adults Fig. 2 - 4 <b>EO118.03</b>	
Set for Adults Fig. 2 - 4 <b>EO114.03</b>			Fig. 1 - 4 <b>EO119.04</b>	
Fig. 1 - 4 <b>EO115.04</b>				

				
	<b>EO132.01</b> 5.5 x 6.5 mm Fig. 1	<b>EO132.04</b> 8.5 x 9.5 mm Fig. 4	<b>EO134.01</b> Ø 5.5 mm Fig. 1	<b>EO134.05</b> Ø 9.5 mm Fig. 5
				
<b>EO132.02</b> 6.5 x 7.5 mm Fig. 2	<b>EO132.05</b> 9.5 x 10.5 mm Fig. 5		<b>EO132.02</b> Ø 6.5 mm Fig. 2	<b>EO134.06</b> Ø 10.5 mm Fig. 6
				
<b>ZOELLNER</b> 3.8 cm/1½"	<b>EO132.03</b> 7.5 x 8.5 mm Fig. 3	<b>EO132.06</b> 10.5 x 11.5 mm Fig. 6	<b>EO134.03</b> Ø 7.5 mm Fig. 3	<b>EO134.07</b> Ø 11.5 mm Fig. 7
Ear specula set <b>EO132.00</b> Fig. 1 - 6			<b>EO134.04</b> Ø 8.5 mm Fig. 4	
		<b>FARRIOR</b> 3.5 cm/1½"		
		Ear specula set <b>EO134.00</b> Fig. 1 - 7		



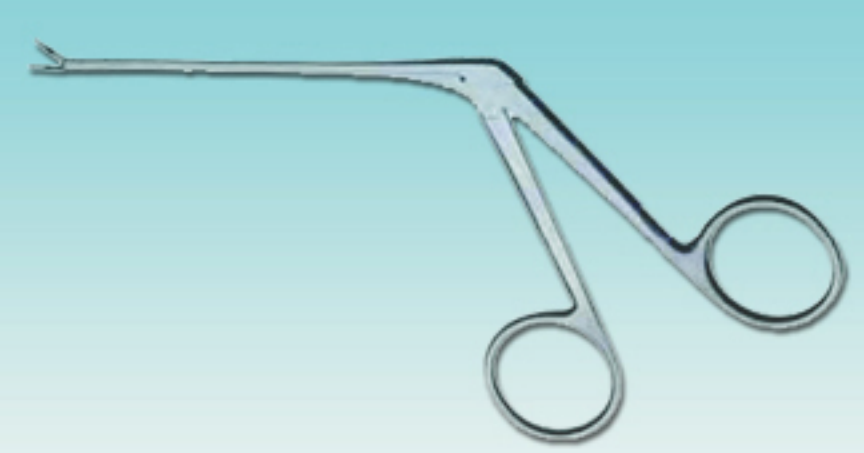

## Otology (Micro Specul)

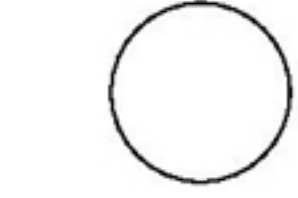

**EO120.82**  
Ø 8.2 mm

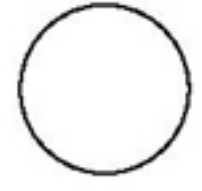

**EO120.77**  
Ø 7.7 mm

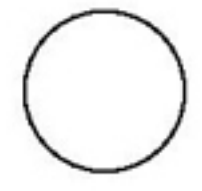

**EO120.72**  
Ø 7.2 mm

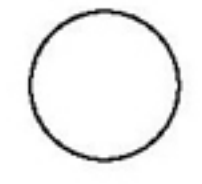

**EO120.67**  
Ø 6.7 mm

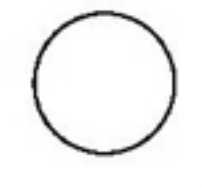

**EO120.63**  
Ø 6.3 mm

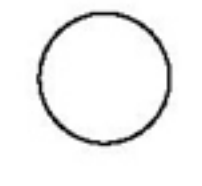

**EO120.58**  
Ø 5.8 mm

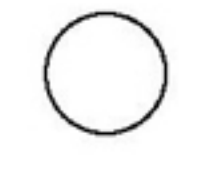

**EO120.53**  
Ø 5.3 mm



**EO120.48**  
Ø 4.8 mm



**EO120.43**  
Ø 4.3 mm



**EO120.38**  
Ø 3.8 mm

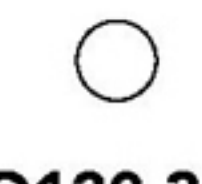

**EO120.33**  
Ø 3.3 mm



FARRIOR

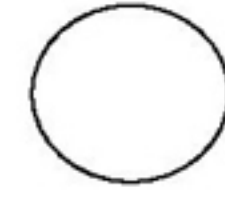

**EO121.90**  
9.0 mm

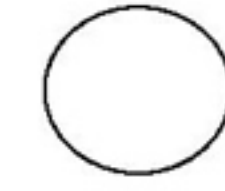

**EO121.85**  
8.5 mm

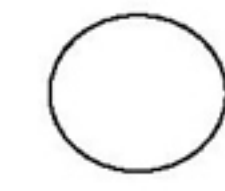

**EO121.80**  
8.0 mm

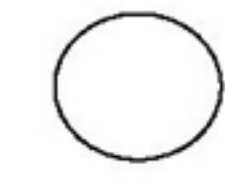

**EO121.75**  
7.5 mm

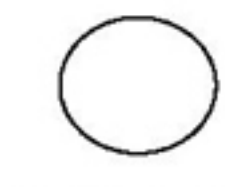

**EO121.70**  
7.0 mm

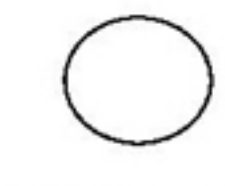

**EO121.65**  
6.5 mm



**EO121.60**  
6.0 mm



**EO121.55**  
5.5 mm



**EO121.50**  
5.0 mm



**EO121.45**  
4.5 mm

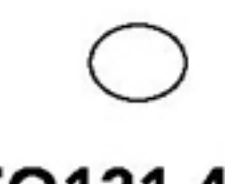

**EO121.40**  
4.0 mm



FARRIOR



FARRIOR

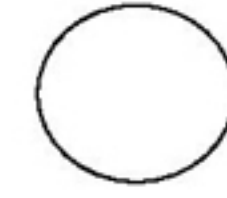

**EO122.90**  
9.0 mm

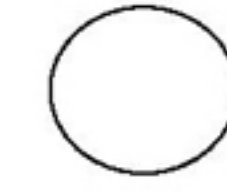

**EO122.85**  
8.5 mm

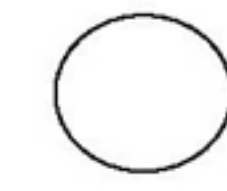

**EO122.80**  
8.0 mm

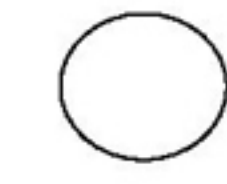

**EO122.75**  
7.5 mm

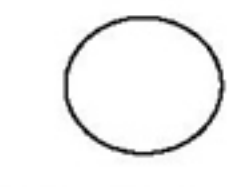

**EO122.70**  
7.0 mm

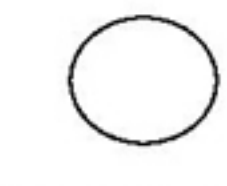

**EO122.65**  
6.5 mm



**EO122.60**  
6.0 mm



**EO122.55**  
5.5 mm

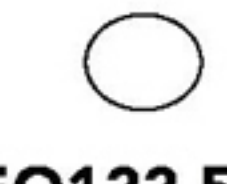

**EO122.50**  
5.0 mm



**EO122.45**  
4.5 mm

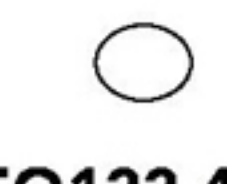

**EO122.40**  
4.0 mm



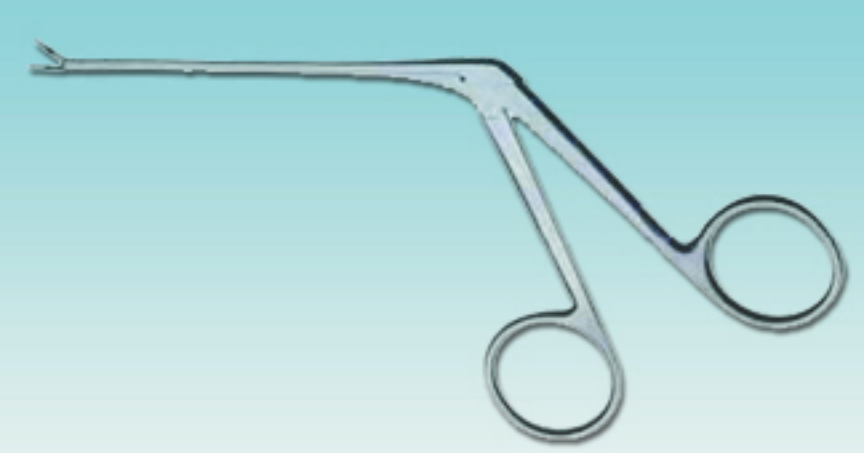

## Otology (Tuning Forks)

**ALUMINIUM**

with dampers



**MARTIN**  
**EO180.10**  
C 128



**MARTIN**  
**EO182.11**  
C 256



**MARTIN-ALLOY**  
**EO184.12**  
C 512



**MARTIN-ALLOY**  
**EO186.13**  
C 1024



**MARTIN-ALLOY**  
**EO188.14**  
C 2048



**HARTMANN**  
**EO189.10**  
C 128



**HARTMANN**  
**EO192.11**  
C¹ 256



**HARTMANN**  
**EO194.12**  
C² 512



**HARTMANN**  
**EO196.13**  
C³ 1024



**HARTMANN**  
**EO198.14**  
C⁴ 2048



**HARTMANN**  
**EO200.15**  
C⁵ 4096

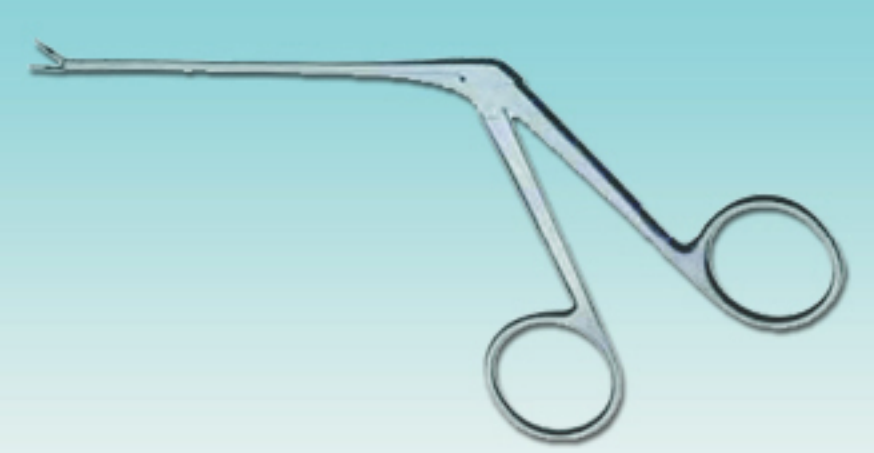

## Otology (Tuning Forks)



LUCAE  
EO210.10  
C 128



LUCAE  
EO212.11  
C<sup>1</sup> 256



LUCAE  
EO214.12  
C<sup>2</sup> 512



LUCAE  
EO216.13  
C<sup>3</sup> 1024



LUCAE  
EO218.14  
C<sup>4</sup> 2048



LUCAE  
EO220.15  
C<sup>5</sup> 4096



LUCAE  
EO221.10  
C 128

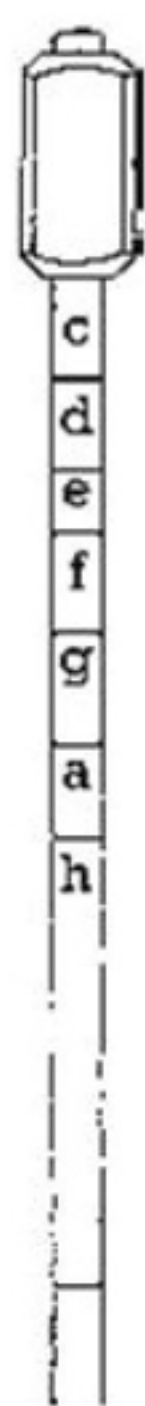

HARTMANN  
EO222.10  
C 128

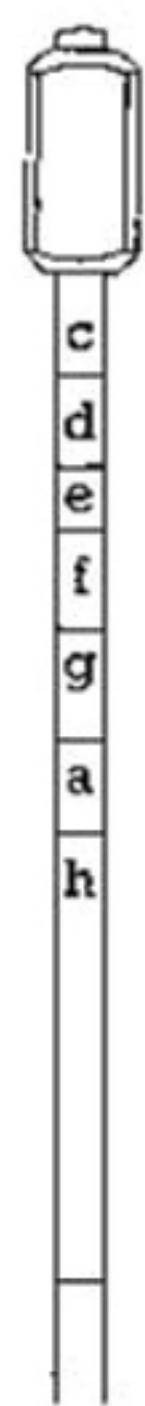

KOENIG  
EO230.59  
C 109

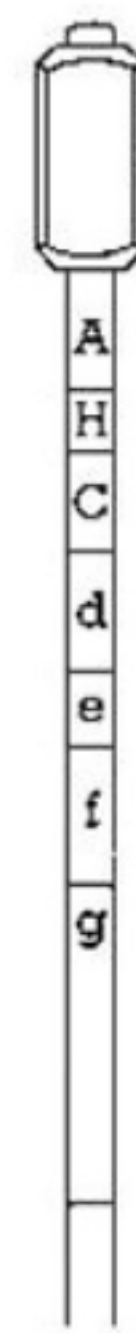

HARTMANN  
EO223.11  
C<sup>1</sup> 128



EO234.61  
a<sup>1</sup> 440

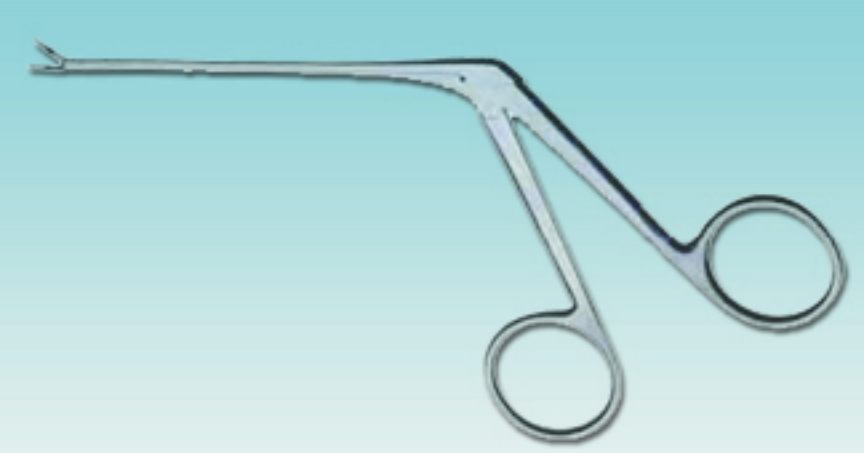

## Otology (Tuning Forks)



FRENCH  
**EO170.07**  
C<sup>2</sup> 16



FRENCH  
**EO172.08**  
C<sup>1</sup> 32



HARTMANN  
**EO172.09**  
C<sup>1</sup> 32



HARTMANN  
**EO174.10**  
C 128



HARTMANN  
**EO177.11**  
C<sup>1</sup> 256



NEURO  
**EO226.00**  
C 64/C 128

hammer, panwheel  
brush & wheel



**EO224.90** **EO224.91**

Damper white  
scale for  
EO.224.10

Damper Black  
scale for  
EO.224.10

**EO224.92** **EO224.93**

Knurled Screw  
for EO224.10

Weights, C 64  
for EO224.10



RYDEL-SEIFFERT  
**EO224.10**  
C 64/C 128

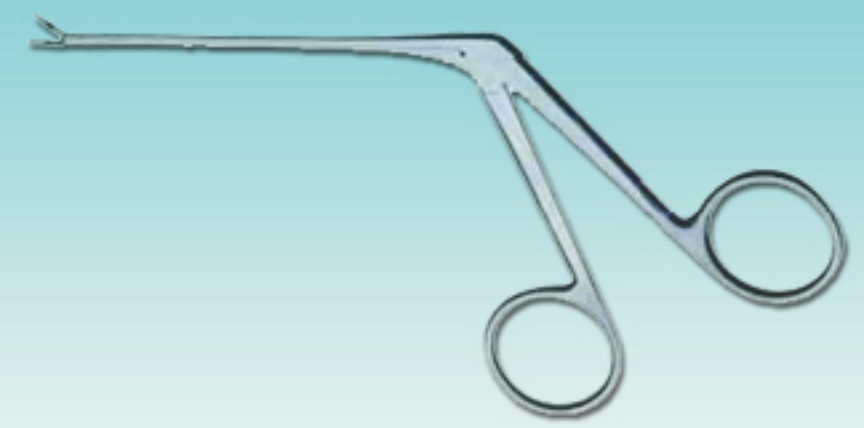

## Otology (Ear Catheters, Polypus Snaers)

Fig. 1  
Fig. 2  
Fig. 3



**HARTMANN**  
15 cm/6"

Ø 3.0 mm **EO321.01**  
Ø 3.5 mm **EO321.02**  
Ø 4.0 mm **EO321.03**

open tip



**KRAUSE**  
**EO351.16**  
18.5 cm/7¼"

close tip



**KRAUSE-VOSS**  
**EO353.16**  
18.5 cm/7¼"

Snare Wire



Snare wire for  
**EO351.16**  
**EO353.16**

Ø 0.3 mm **EO358.30**  
Ø 0.4 mm **EO358.40**

Ø 3 mm

Polypus Snaers for Rhinology



**KRAUSE**  
**EO885.26**  
26 cm/10¼"

Ø 3 mm



**KRAUSE**  
**EO887.26**  
26 cm/10¼"

Snare Wire



Snare wire for  
**EO.885.26**  
**EO.887.26**

Ø 0.3 mm **EO898.30**  
Ø 0.4 mm **EO898.40**

Snare Wire



**EO899.12**  
Ø 0.3 mm

bundle with 12  
pieces

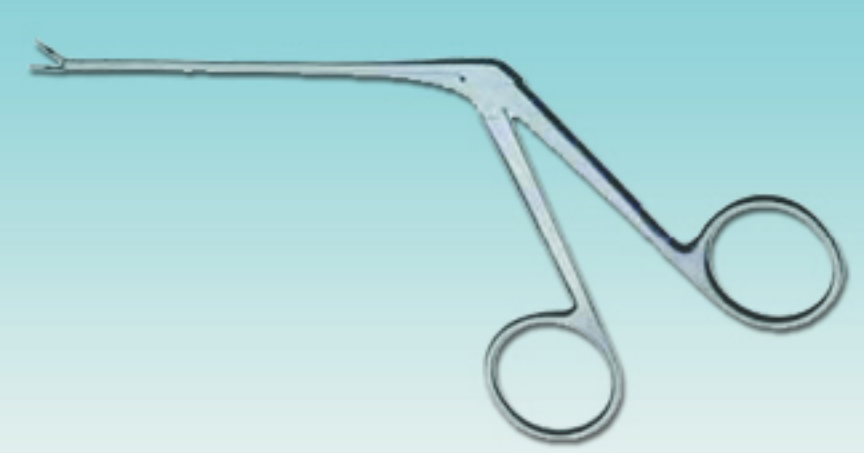

## Otology (Ear Polypus Forceps)



TROELTSCH (WILDE)  
**EO371.11**  
10.5 cm/4"



TROELTSCH (WILDE)  
**EO375.12**  
11 cm/4 1/4"



TROELTSCH (WILDE)  
**EO381.13**  
12.5 cm/4 3/4"



LUCAE  
**EO1000.06**  
14 cm/5 1/2"



GRUENWALD  
**EO391.14**  
14.5 cm/5 3/4"



JANSEN  
16.0 cm/6 1/4" **EO395.16**  
21.5 cm/8 1/2" **EO395.20**

65 mm

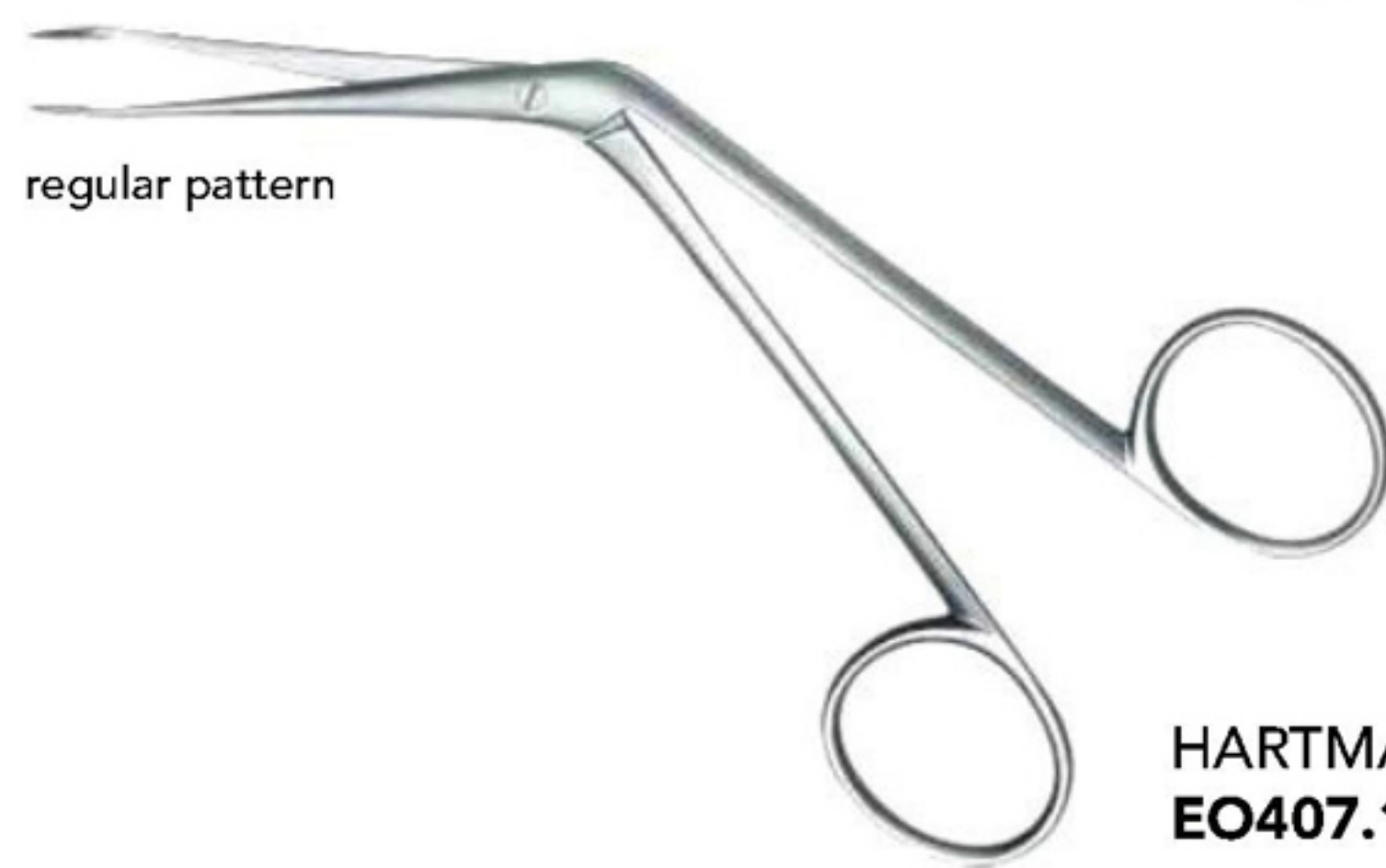

regular pattern

Ear Polypus Forceps

HARTMANN  
**EO407.14**

65 mm

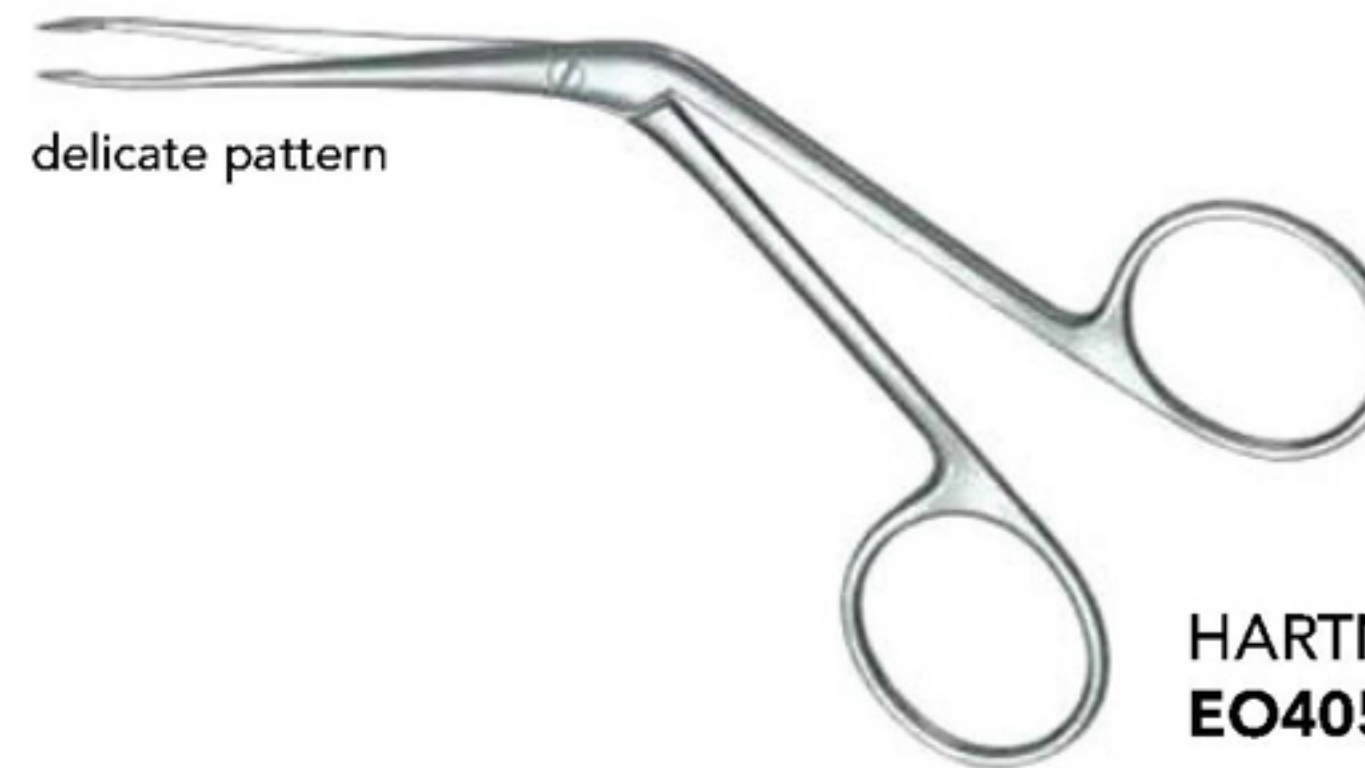

delicate pattern

HARTMANN  
**EO405.12**



Foreign body lever

BUCK  
**EO416.11**  
11.5 cm/4 1/2"



Foreign body lever

QUIRE  
**EO418.10**  
10.5 cm/4 1/4"

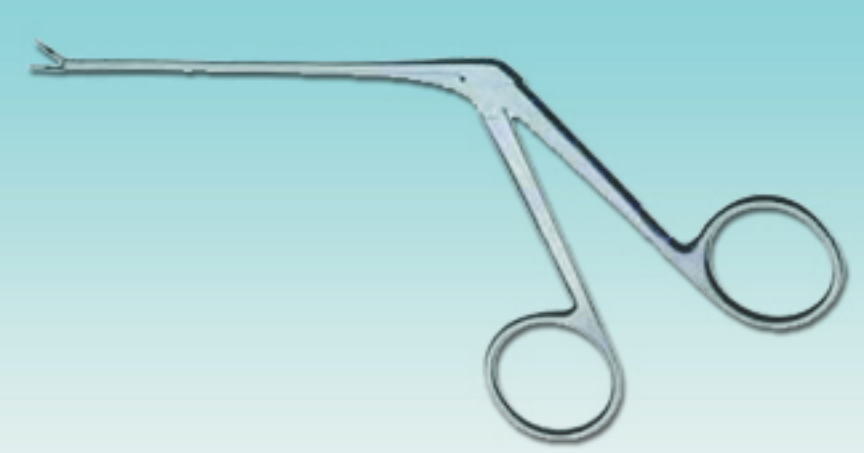

## Otology (Ear Polypus Forceps & Mastoid Rongeurs)

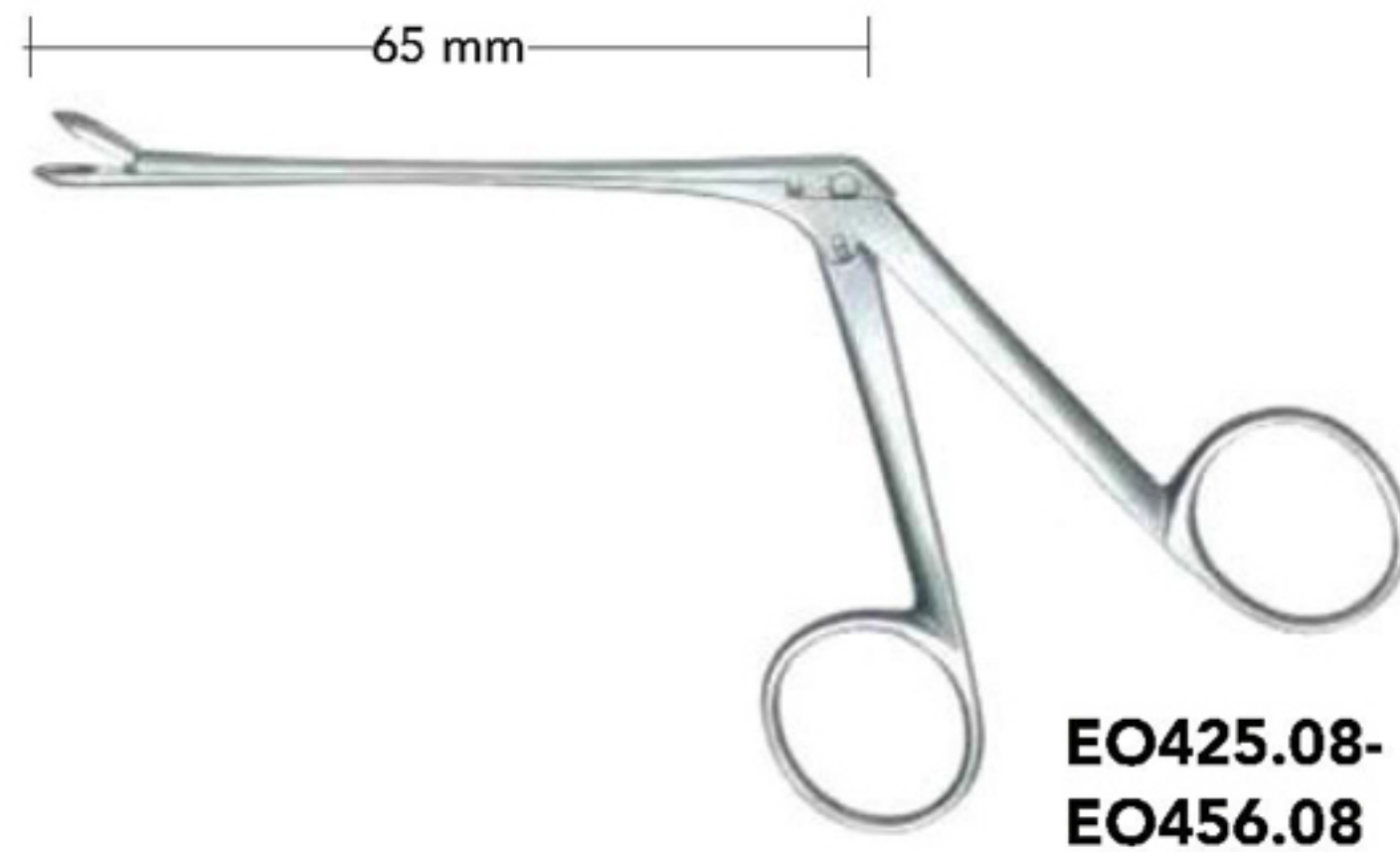

**EO425.08-  
EO456.08**



**HARTMANN-WULLSTEIN  
EO425.08**  
8.5 cm/3 1/4"



**HARTMANN-WULLSTEIN  
EO427.08**  
8.5 cm/3 1/4"



**HARTMANN-WULLSTEIN  
EO445.08**  
8.5 cm/3 1/4"



**HARTMANN  
EO430.08**  
8.5 cm/3 1/4"



**HARTMANN  
EO430.14**  
14 cm/5 1/2"



**HARTMANN  
EO430.31**  
8.5 cm/3 1/4"



**HARTMANN-  
HOFFMANN  
EO456.08**  
8.5 cm/3 1/4"



**HARTMANN-HERZFELD  
EO442.81**  
8.5 cm/3 1/4"



**HARTMANN-HERZFELD  
EO442.82**  
8.5 cm/3 1/4"

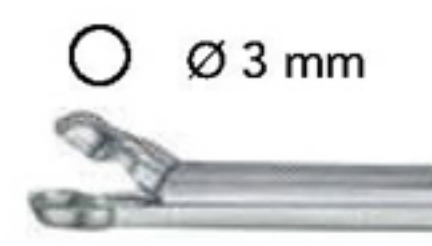

**HARTMANN-HERZFELD  
EO442.83**  
8.5 cm/3 1/4"



**STRÜMPEL  
EO448.08**  
8.5 cm/3 1/4"





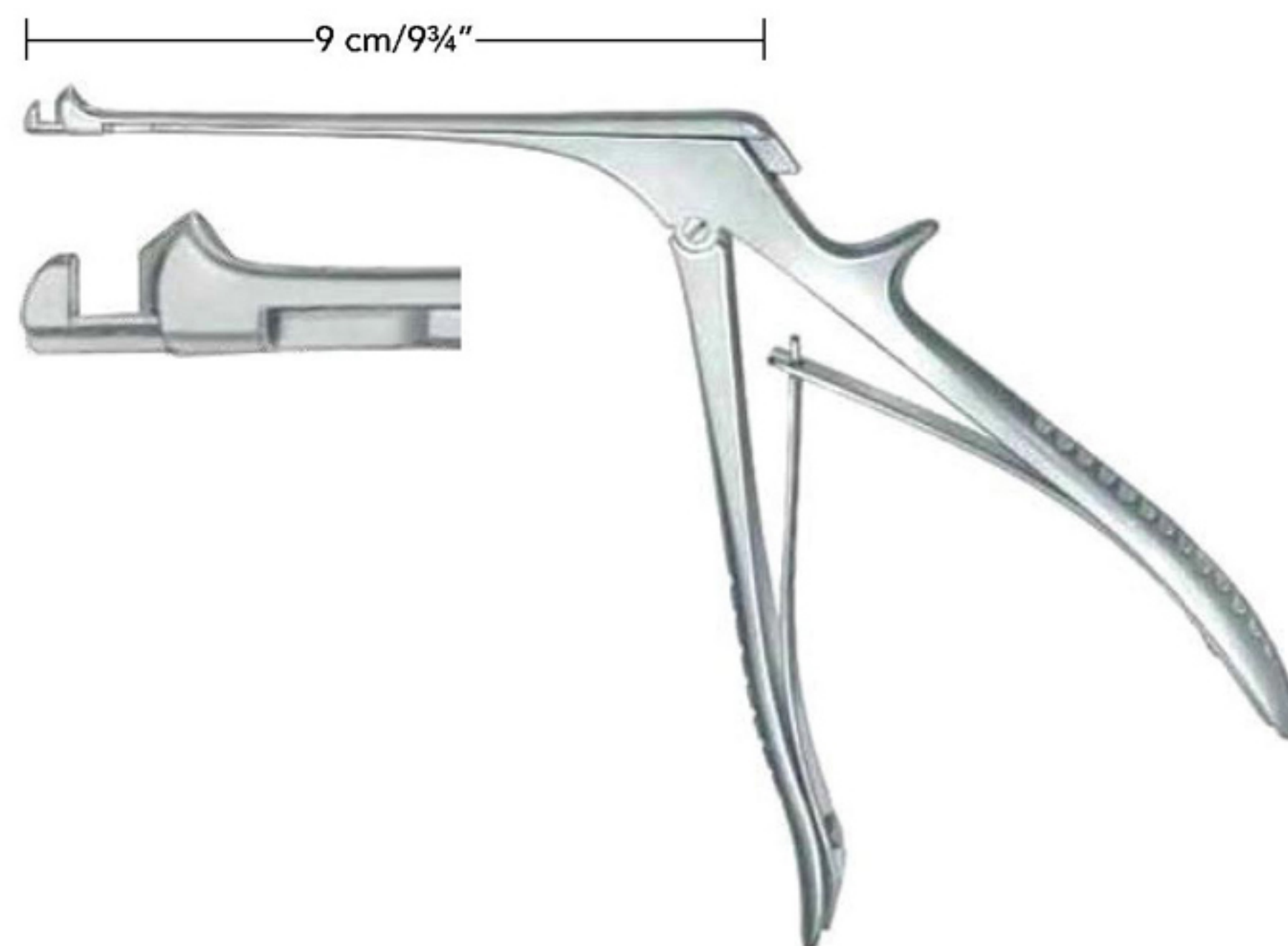



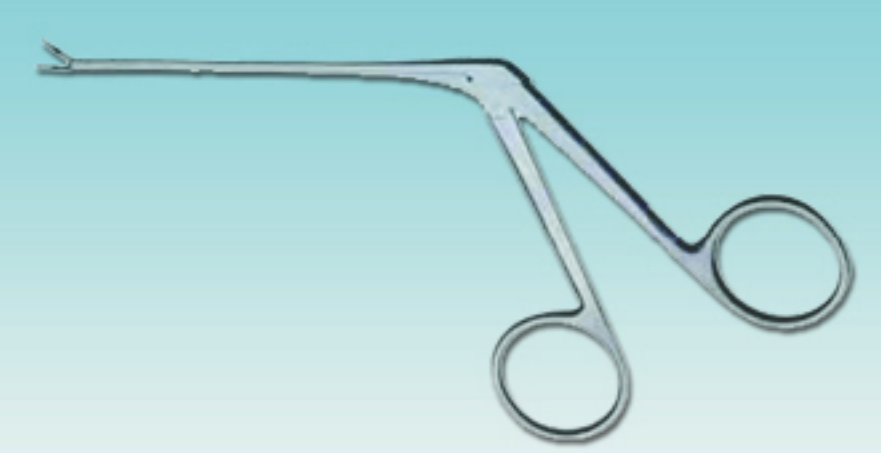









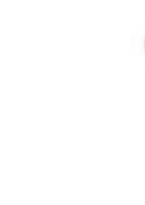











**CITELLI  
EO461.17**



Jaw BEYER  
1 mm **EO463.19**  
2 mm **EO466.14**



## Otology (Ear, Hooklet, Tympanum Needles)

 <p>straight    angled</p> <p><b>BUCK</b> 15 cm/6"</p>	sharp							
		<b>EO494.01</b> 1.8 mm Fig. 000	<b>EO494.02</b> 2.1 mm Fig. 00	<b>EO494.03</b> 2.6 mm Fig. 0	<b>EO494.04</b> 3.2 mm Fig. 1	<b>EO494.05</b> 3.7 mm Fig. 2	<b>EO494.06</b> 4.1 mm Fig. 3	<b>EO494.07</b> 4.4 mm Fig. 4
	blunt							
		<b>EO495.01</b> 1.8 mm Fig. 000	<b>EO495.02</b> 2.1 mm Fig. 00	<b>EO495.03</b> 2.6 mm Fig. 0	<b>EO495.04</b> 3.2 mm Fig. 1	<b>EO495.05</b> 3.7 mm Fig. 2	<b>EO495.06</b> 4.1 mm Fig. 3	<b>EO495.07</b> 4.4 mm Fig. 4
	sharp							
		<b>EO496.01</b> 1.8 mm Fig. 000	<b>EO496.02</b> 2.1 mm Fig. 00	<b>EO496.03</b> 2.6 mm Fig. 0	<b>EO496.04</b> 3.2 mm Fig. 1	<b>EO496.05</b> 3.7 mm Fig. 2	<b>EO496.06</b> 4.1 mm Fig. 3	<b>EO496.07</b> 4.4 mm Fig. 4
	blunt							
		<b>EO497.01</b> 1.8 mm Fig. 000	<b>EO497.02</b> 2.1 mm Fig. 00	<b>EO497.03</b> 2.6 mm Fig. 0	<b>EO497.04</b> 3.2 mm Fig. 1	<b>EO497.05</b> 3.7 mm Fig. 2	<b>EO497.06</b> 4.1 mm Fig. 3	<b>EO497.07</b> 4.4 mm Fig. 4

						
<b>LANGENBECK</b> <b>EO491.13</b> 13 cm/5"	<b>SHAPLEIGH</b> 15 cm/6"	<b>JANSEN</b> <b>EO532.15</b> 16 cm/6¼"	<b>GROSS</b> <b>EO543.12</b> 16 cm/5"	<b>WEBER-LOCH</b> <b>EO551.01</b> 17 cm/6"	<b>BILLEAU</b> 16.5/6½"	<b>MOLDENHAUER</b> <b>EO561.16</b> 16 cm/6¼"
	blunt	 <b>EO493.01</b> Fig. 1			 <b>EO554.01</b> Fig. 1	
		 <b>EO493.02</b> Fig. 2			 <b>EO554.02</b> Fig. 2	
					 <b>EO554.03</b> Fig. 3	

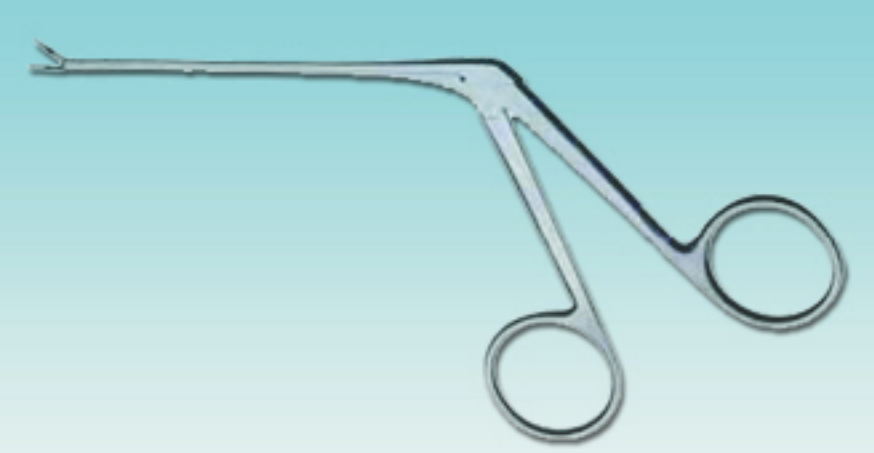

## Otology (Ear Hooklet, Tympanum Needles)

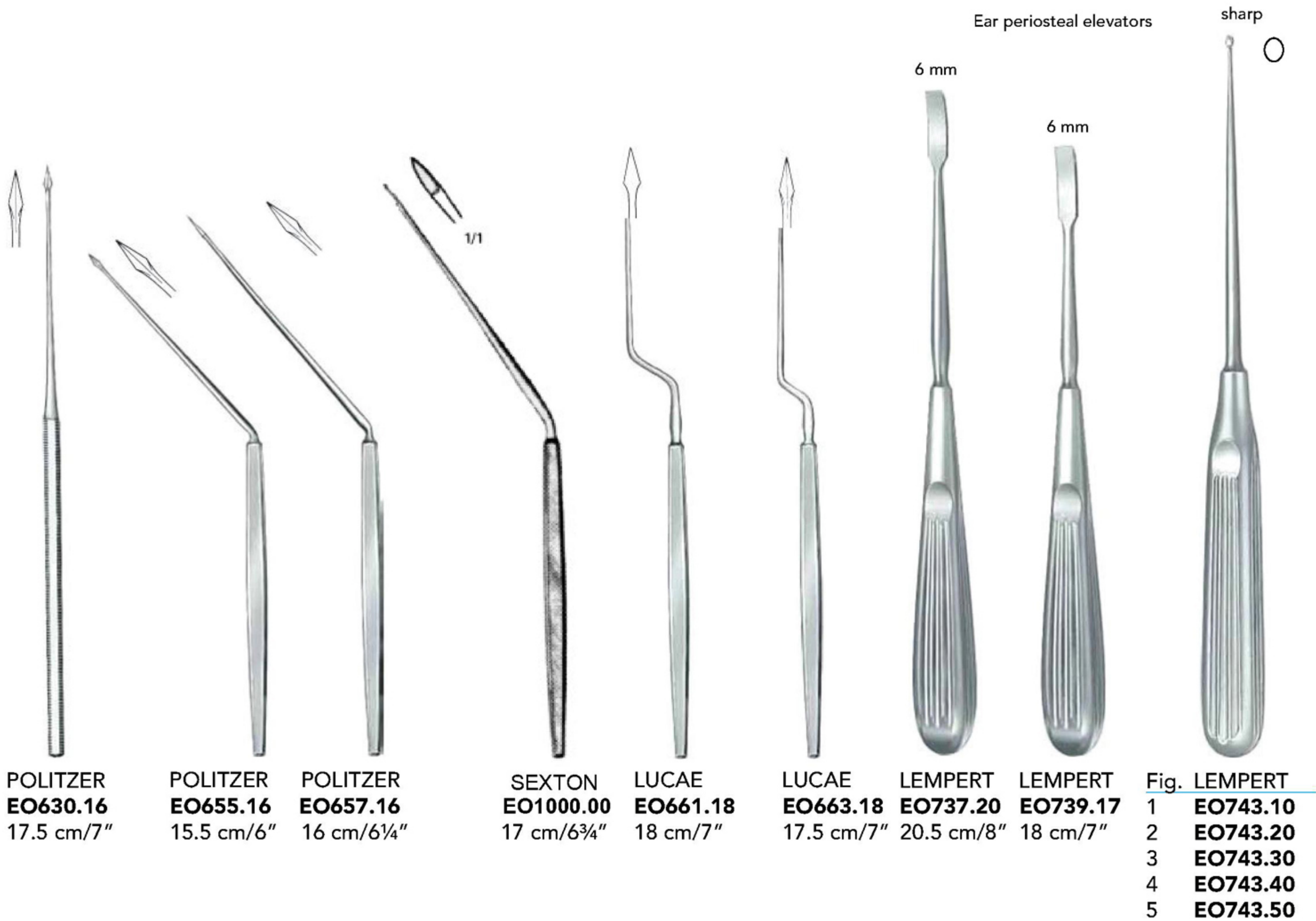
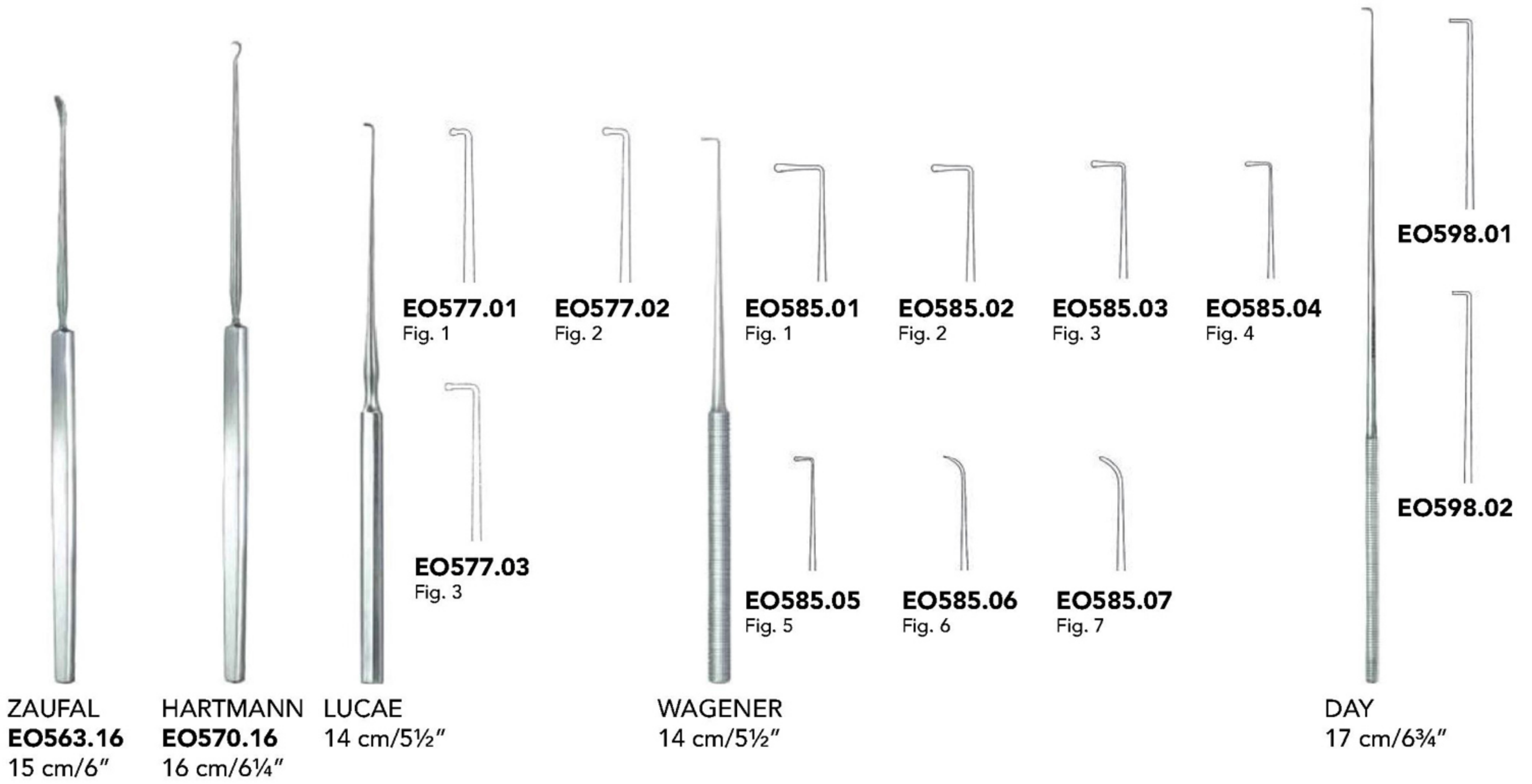



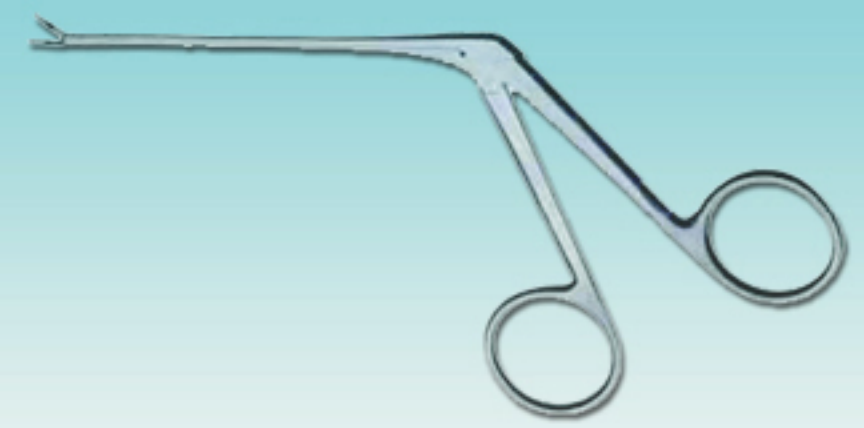

## Otology (Ear Syringes)

Valve Attachment



**EO794.02**

Suction Nozzle



**EO794.04**

Protecting Disc



**EO794.05**

Metal Olive



**EO794.06**

Conical tip



**EO794.07**

Button ended tip



**EO794.08**

Threaded tip



**EO794.09**



**EO794.03**

Flexible tube



**EO794.00**

complete, self filling  
in plastic pouch

Irrigation adapter



**EO795.91**

Irrigation adapter



**EO795.92**



**EO795.00**  
50 ml

complete with protection  
disc & 2 tips

**EO795.04**  
100 ml

complete with protection  
disc & 2 tips

**EO795.90**  
Ear Syringe