

Rhinology (Nasal Speculas)

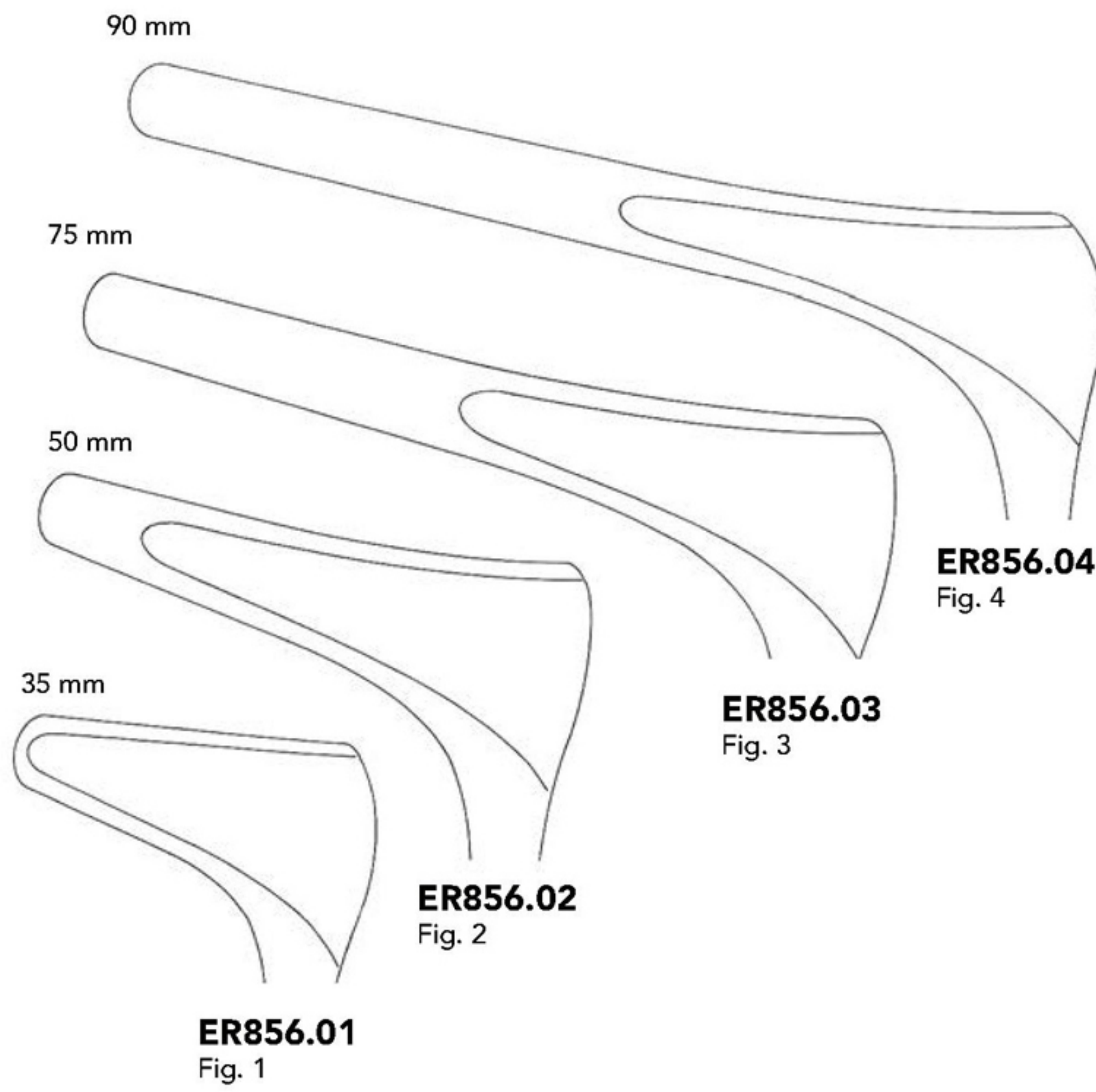

KILLIAN
14 cm/5½"



HARTMANN-HALLE
14 cm/5½"

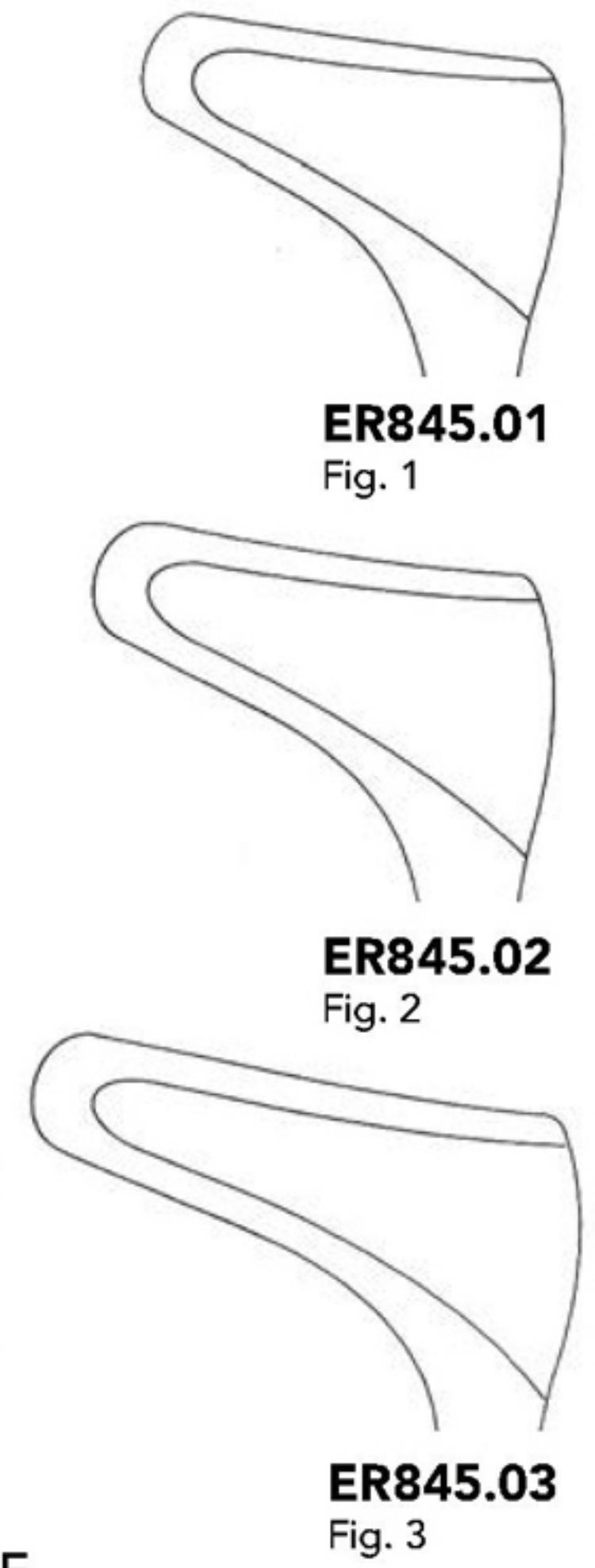

COTTLE
15 cm/6"

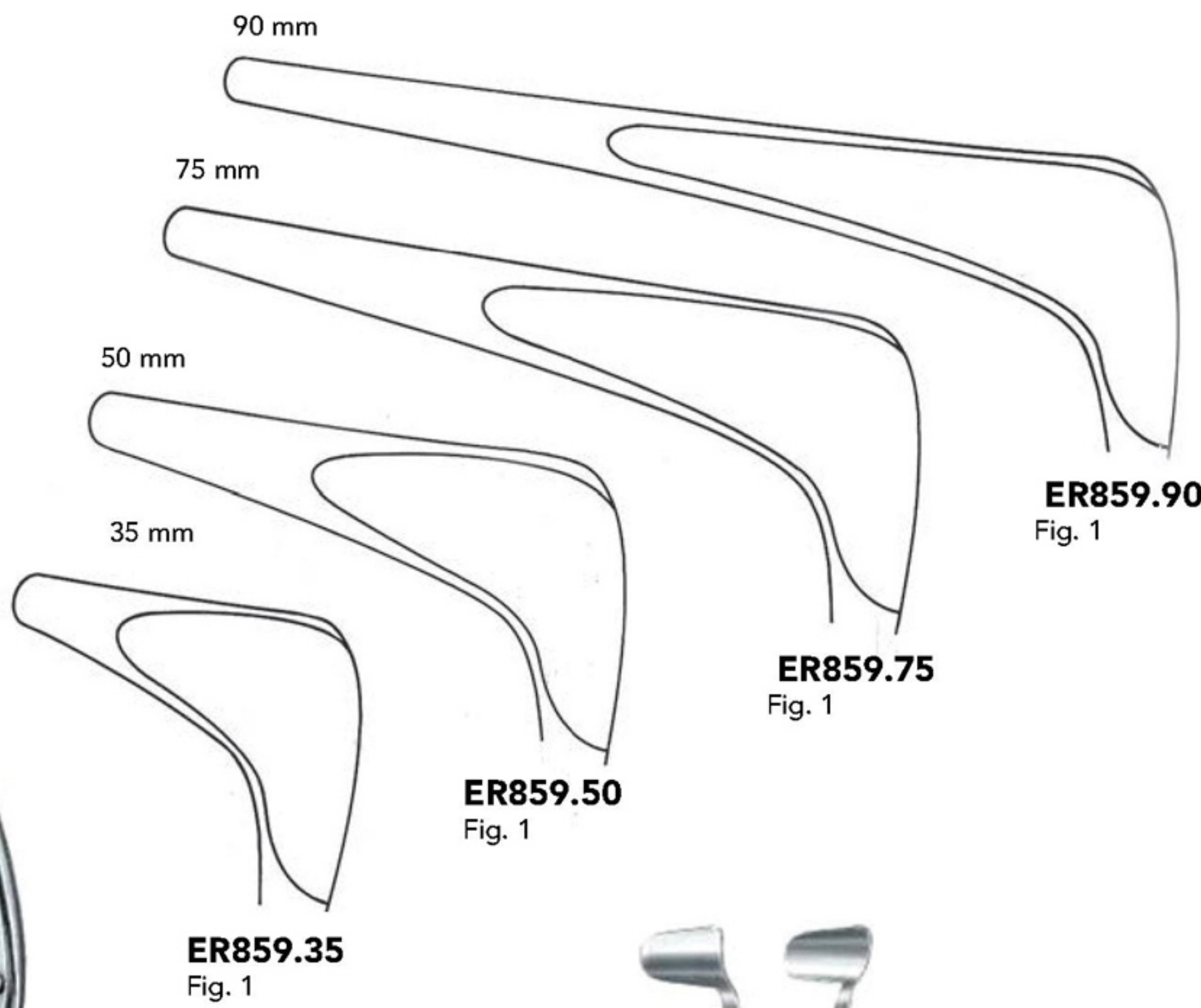

GOLDSMITH-THUDICHUM
Fig. Blades 6.5 cm/2½"

1	18.5 x 9.5 mm	ER817.01
2	21.0 x 10.5 mm	ER817.02
3	21.0 x 11.5 mm	ER817.03



TIECK-HALLE
ER852.13
13 cm/5"



VIENNA
ER858.14
14 cm/5½"

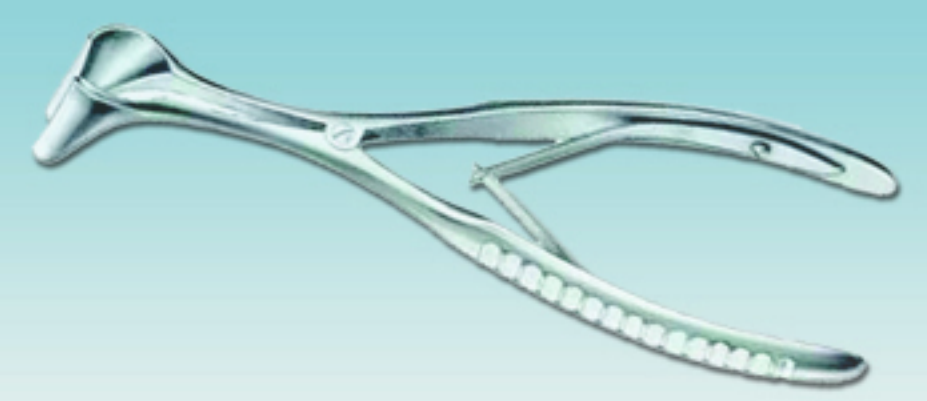

Rhinology (Nasal Speculas)

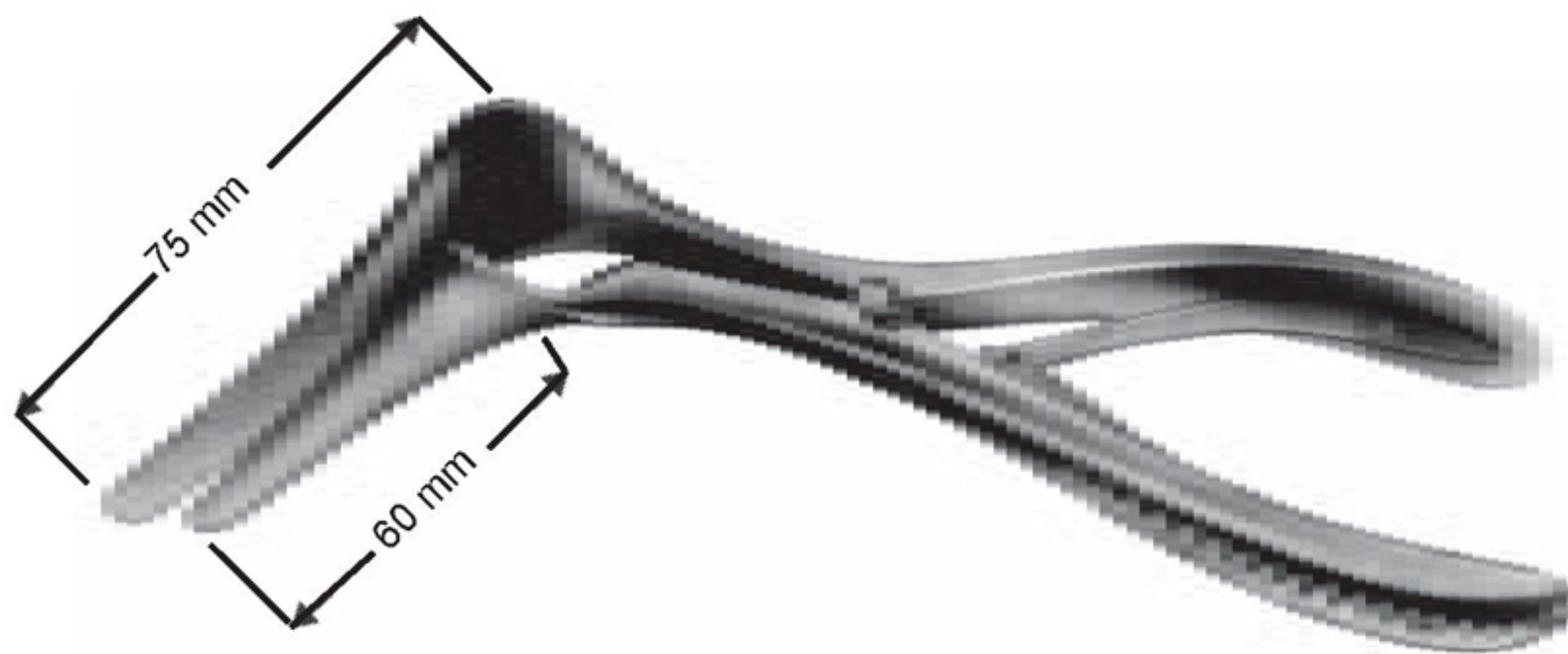
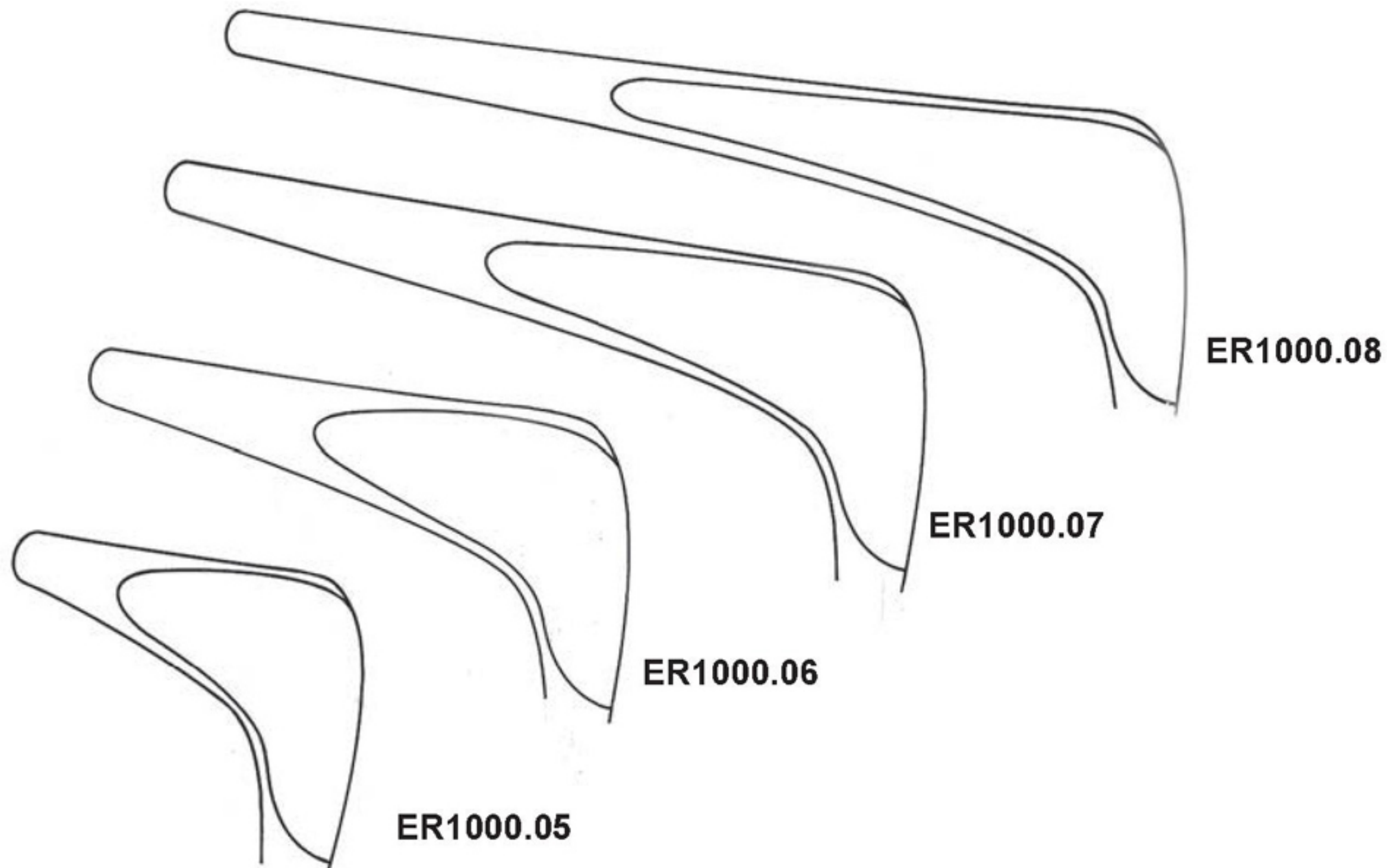

ER1000.09
Kisa sol bleyd,
Left blade shortened

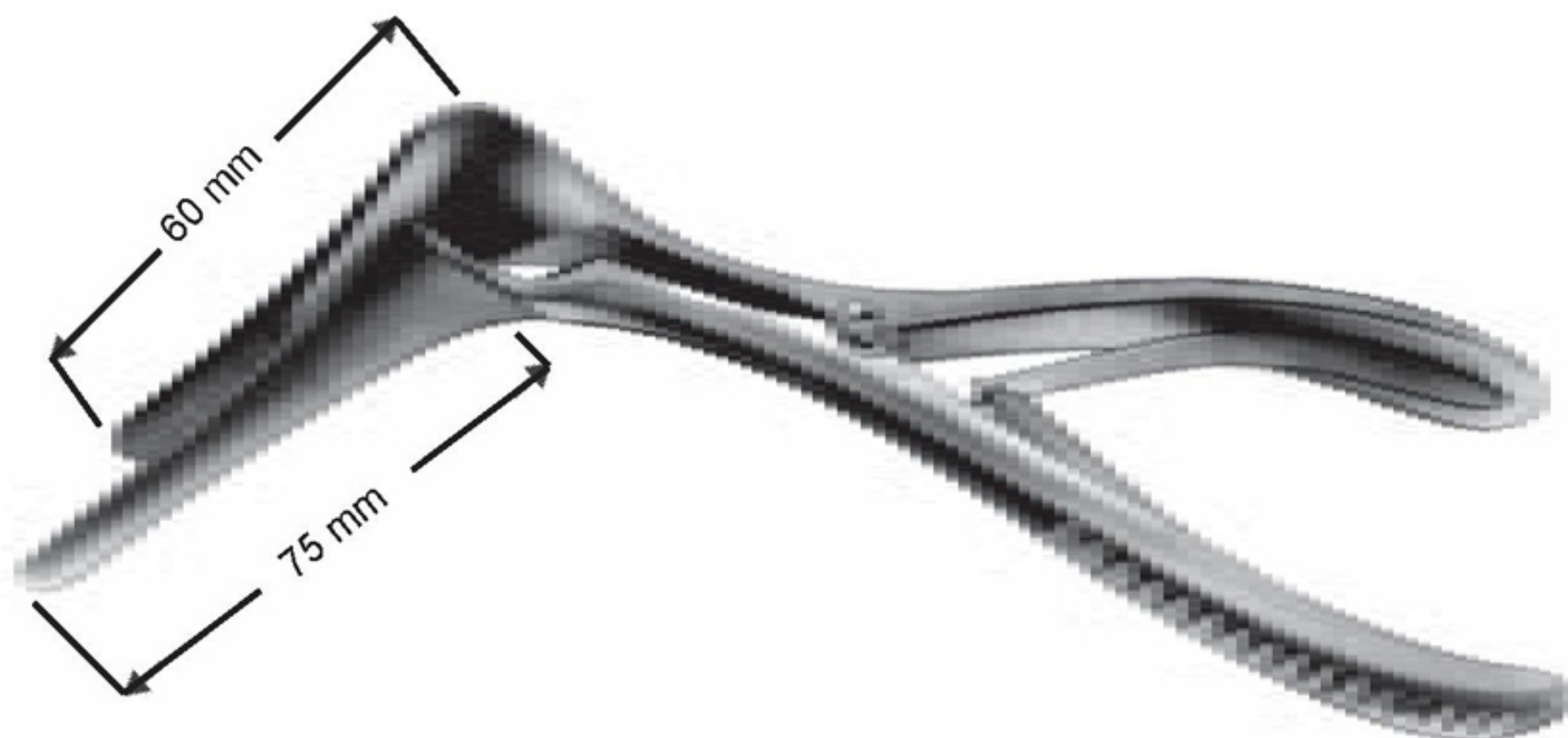

ER1000.10
Kisa sađ bleyd,
Right blade shortened

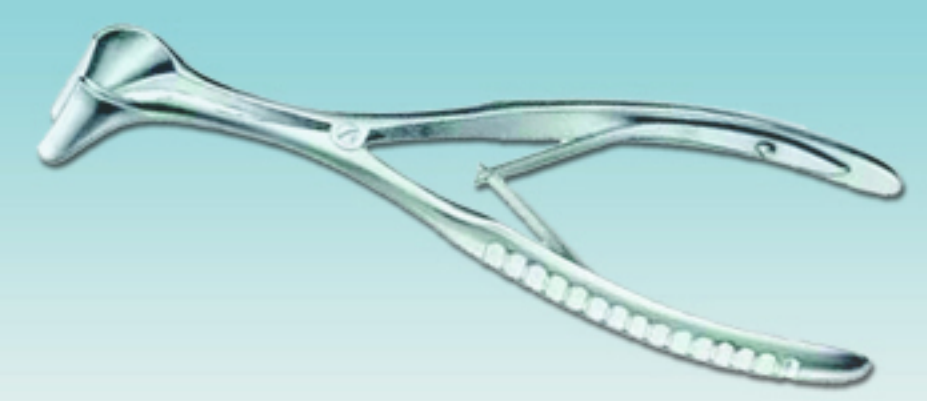

Rhinology (Nasal Tempon & Septum Forceps)

1:2



ER115.16
16 cm/6¼"



TROELTSCH
ER105.18
15.5 cm/6"



TROELTSCH
ER101.15
14.5 cm/5¾"



WESTMACOTT
ER121.20
20 cm/8"

Nasal Polypus
Forceps



LUBET-BARBON
ER129.20
18.5 cm/7¼"



HARTMANN
ER145.20
18.5 cm/7¼"

GRUENWALD (JANSEN)
ER115.20
21.5 cm/8½"



KNIGHT
ER207.18
17 cm/6¾"



GRAIG
ER213.18
16 cm/6¼"



Curved left



KNIGHT
15.5 cm/6"
ER215.01 left curved
ER215.02 right curved



BRUENINGS
16.5 cm/6½"
Fig. 1 **ER227.01**
Fig. 2 **ER227.02**
Fig. 3 **ER227.03**
Fig. 4 **ER227.04**

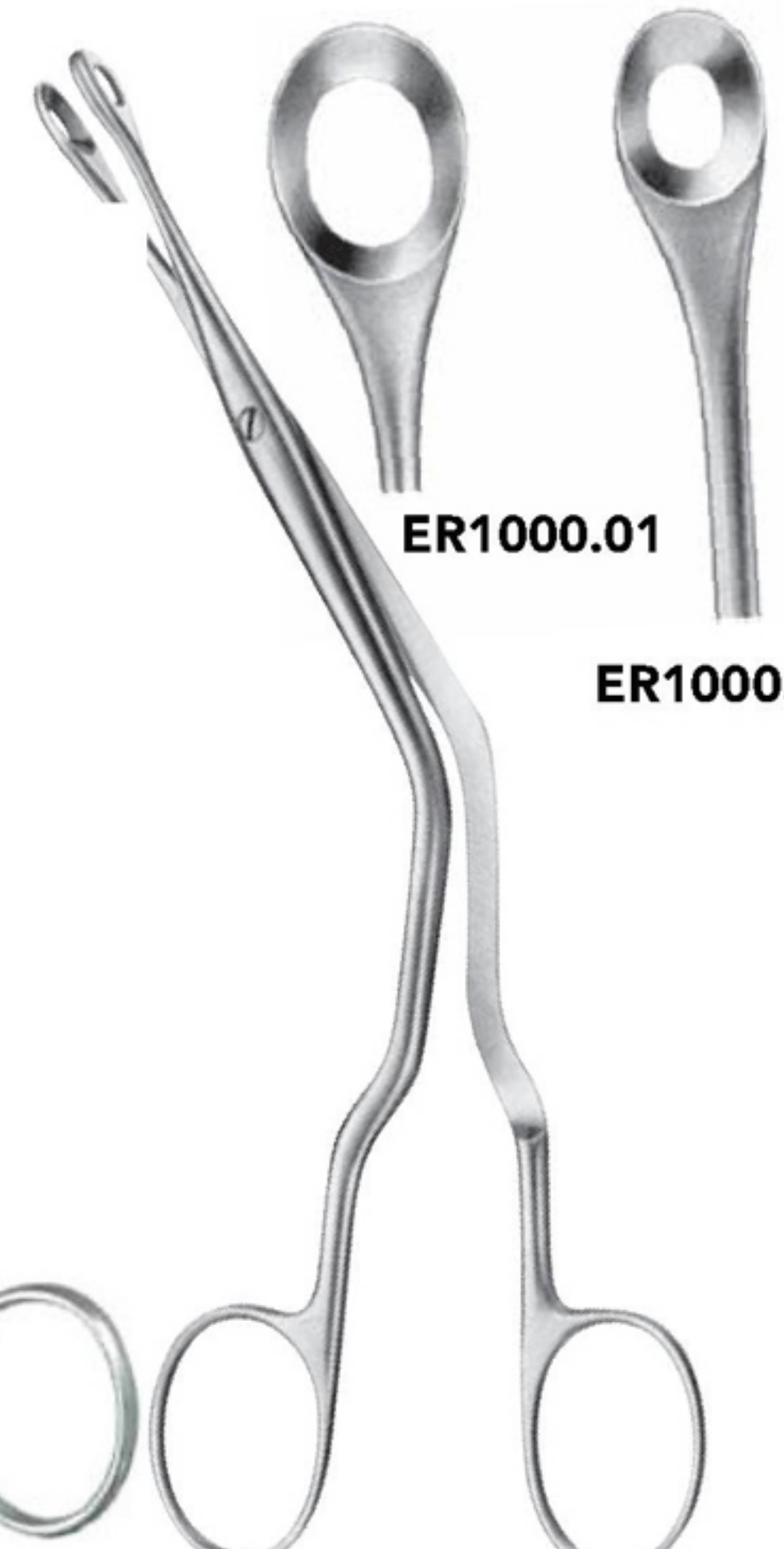

ER1000.01

ER1000.02

LUC
ER1000.01-ER1000.02
20 cm

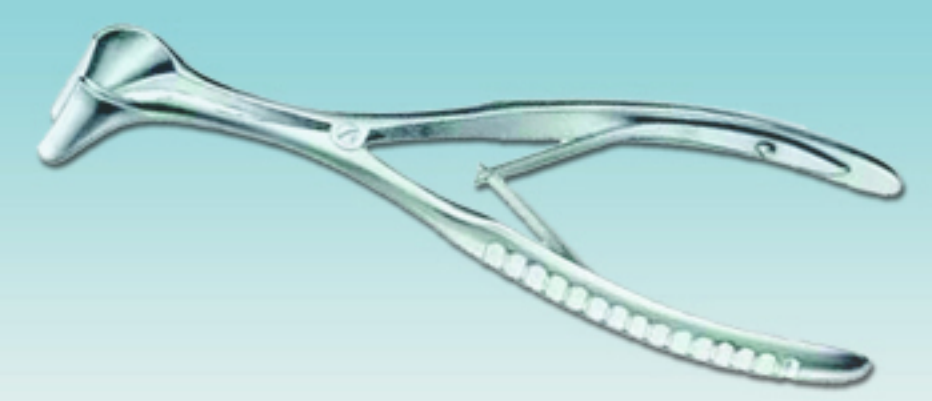

Rhinology (Ethmoid Bone Forceps, Nasal Cutting Forceps)

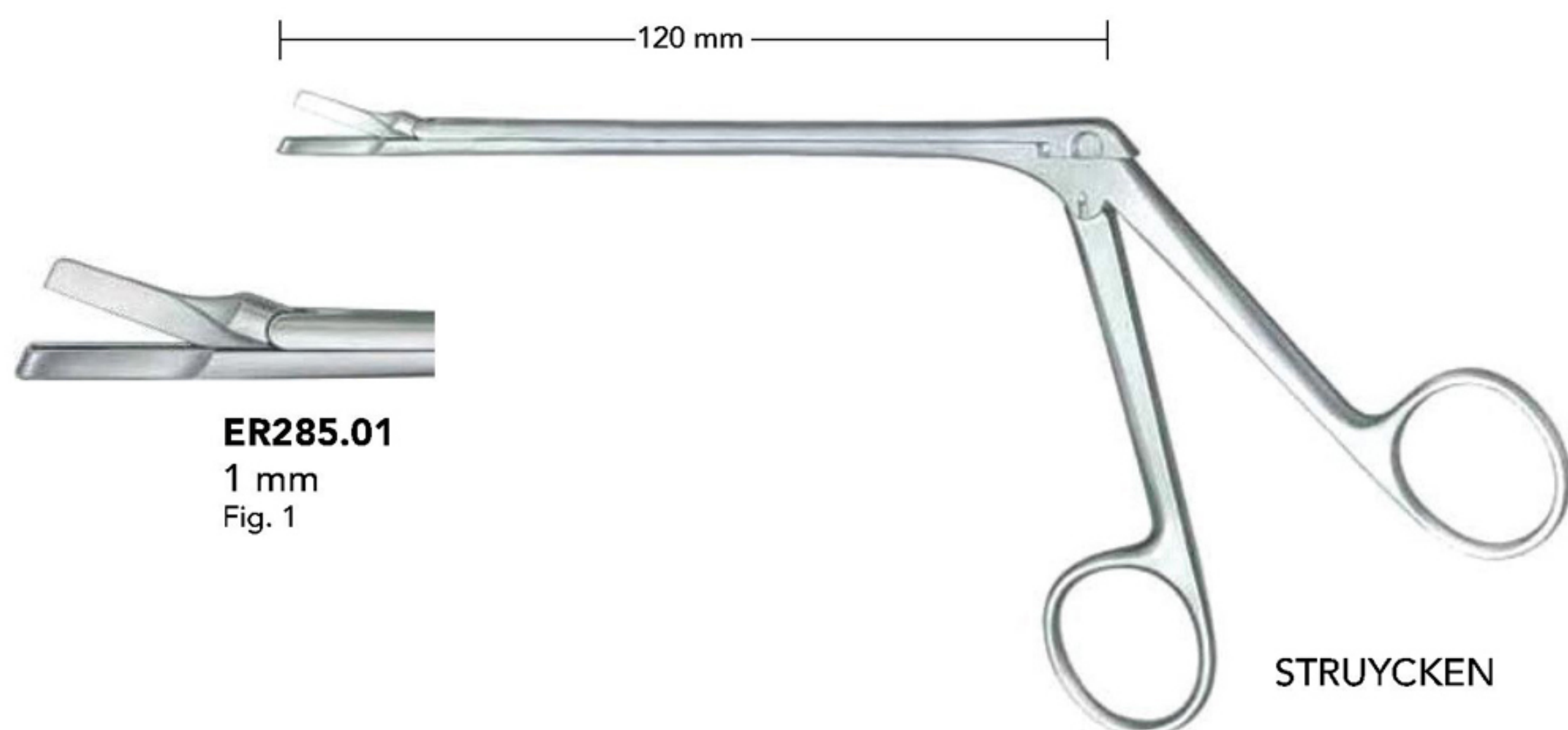
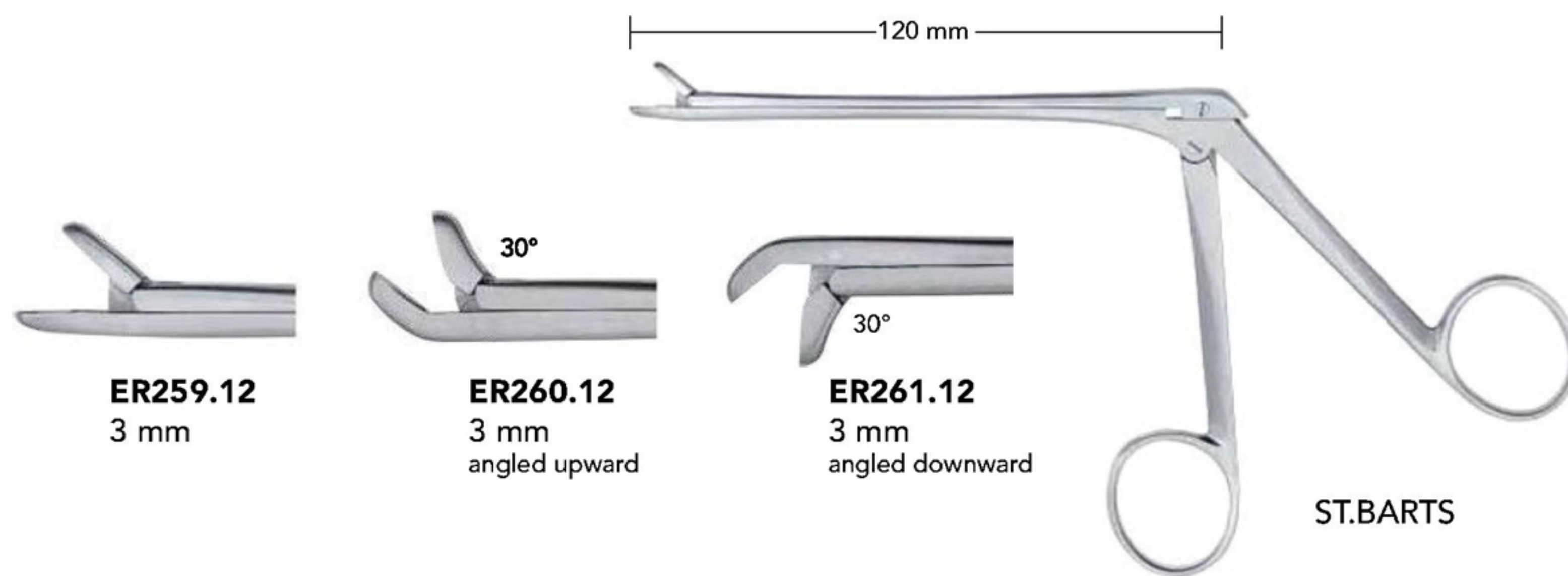
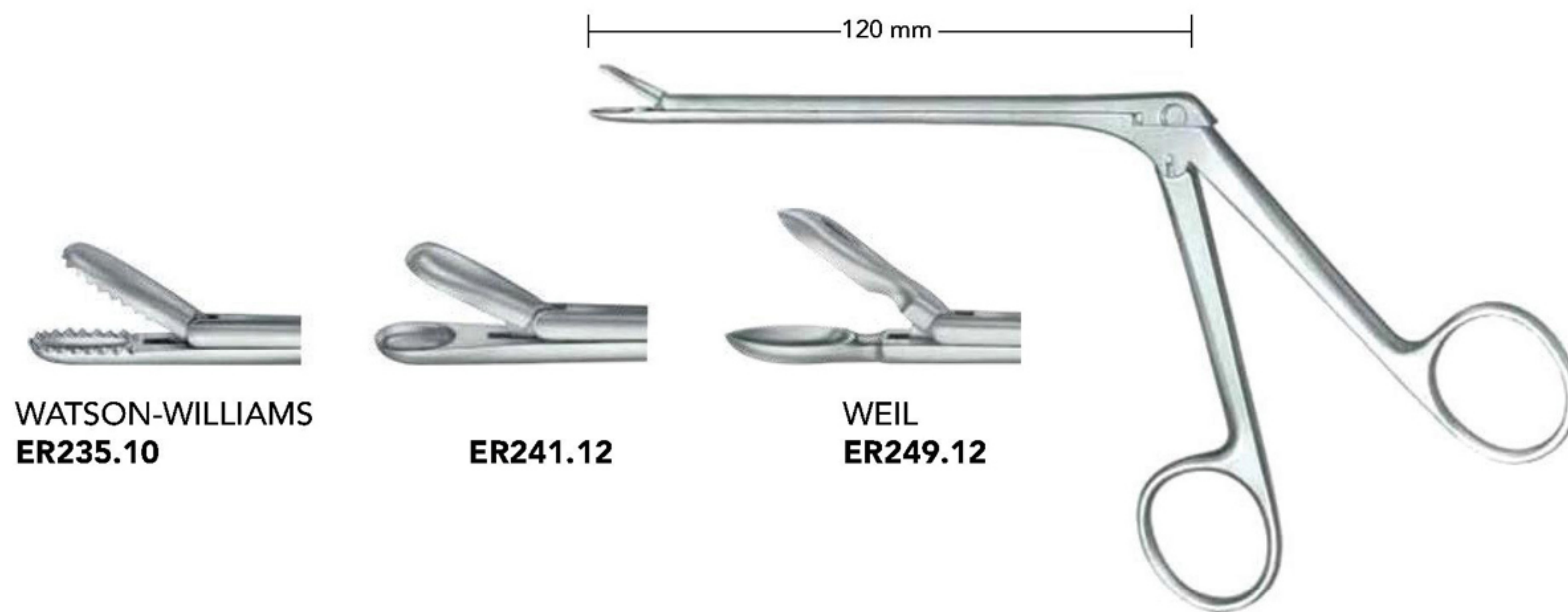
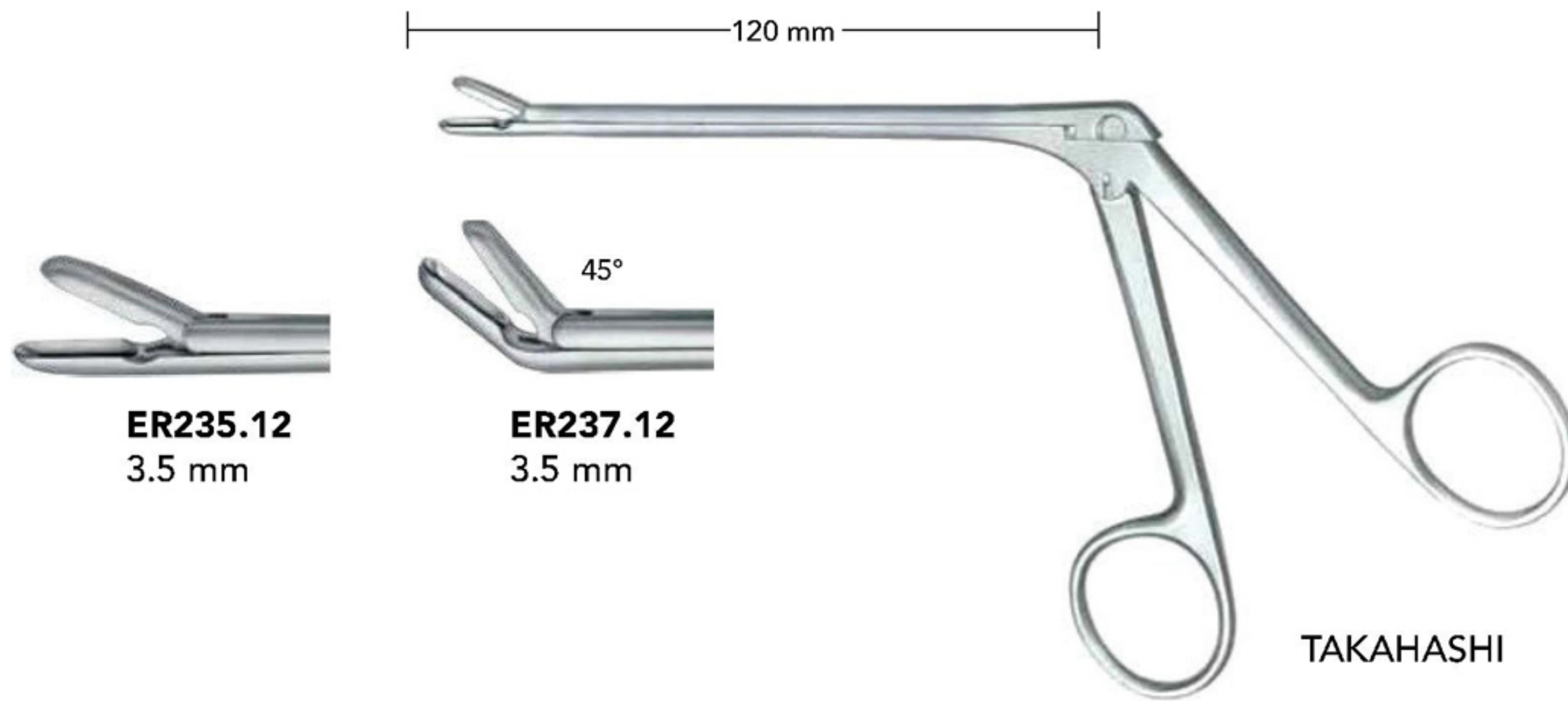

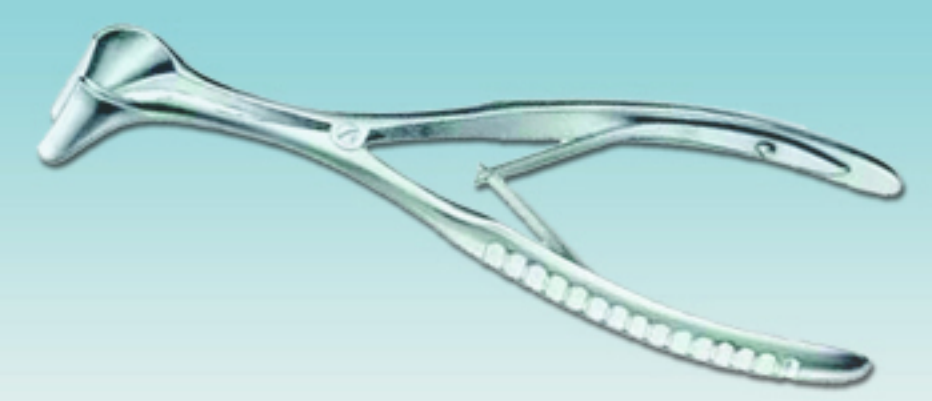

Rhinology (Nasal Cutting Forceps, Antrum Punches)

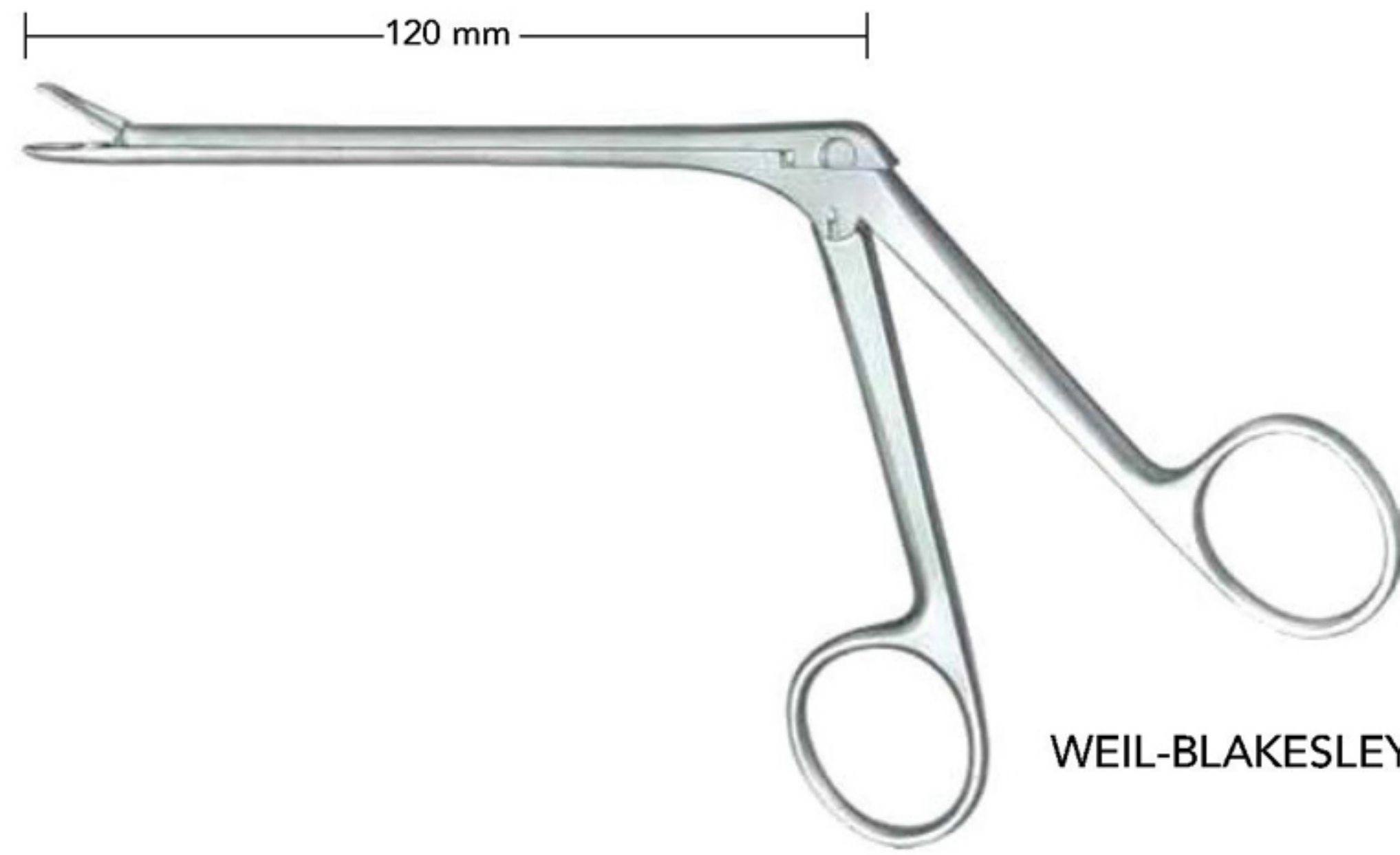

WEIL-BLAKESLEY

straight			ER255.01 3 mm Fig. 1		ER255.02 3.5 mm Fig. 2		ER255.03 4.5 mm Fig. 3		ER255.04 5.5 mm Fig. 4
angled upward			ER256.01 3 mm Fig. 1		ER256.02 3.5 mm Fig. 2		ER256.03 4.5 mm Fig. 3		ER256.04 5 mm Fig. 4
angled upward			ER258.01 3 mm Fig. 1		ER258.02 3.5 mm Fig. 2		ER258.03 4.5 mm Fig. 3		ER258.04 5 mm Fig. 4

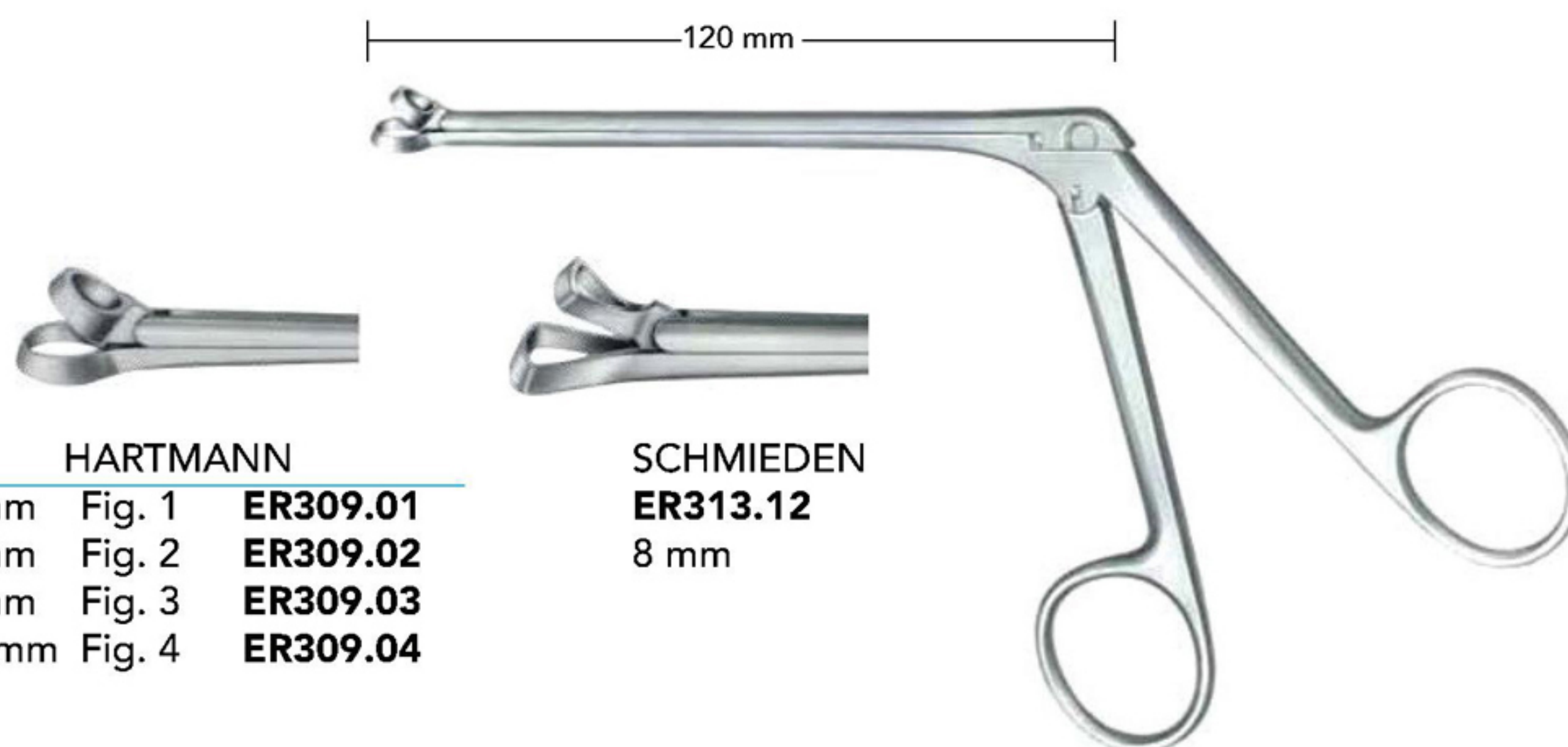

HARTMANN	
Ø 5 mm Fig. 1	ER309.01
Ø 7 mm Fig. 2	ER309.02
Ø 9 mm Fig. 3	ER309.03
Ø 11 mm Fig. 4	ER309.04

SCHMIEDEN
ER313.12
8 mm

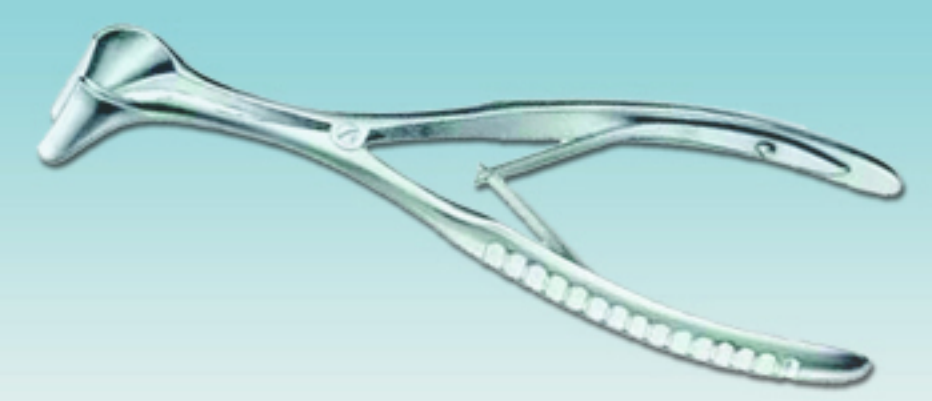

Rhinology (Sphenoid Bone Punches, Antrum Punches)

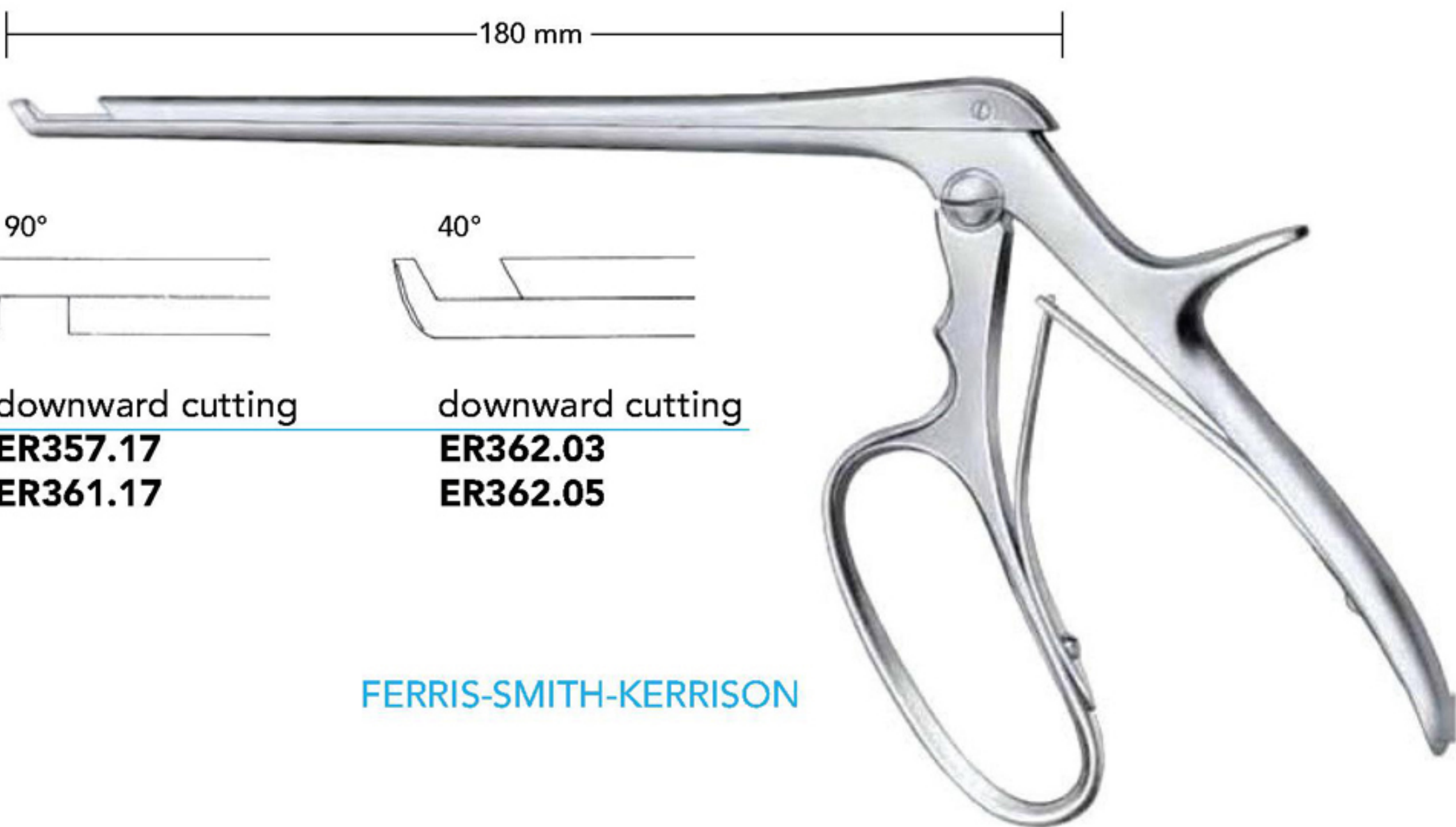

	90°	90°	40°
	upward cutting	downward cutting	downward cutting
3 mm	ER356.17	ER357.17	ER362.03
5 mm	ER360.17	ER361.17	ER362.05

FERRIS-SMITH-KERRISON

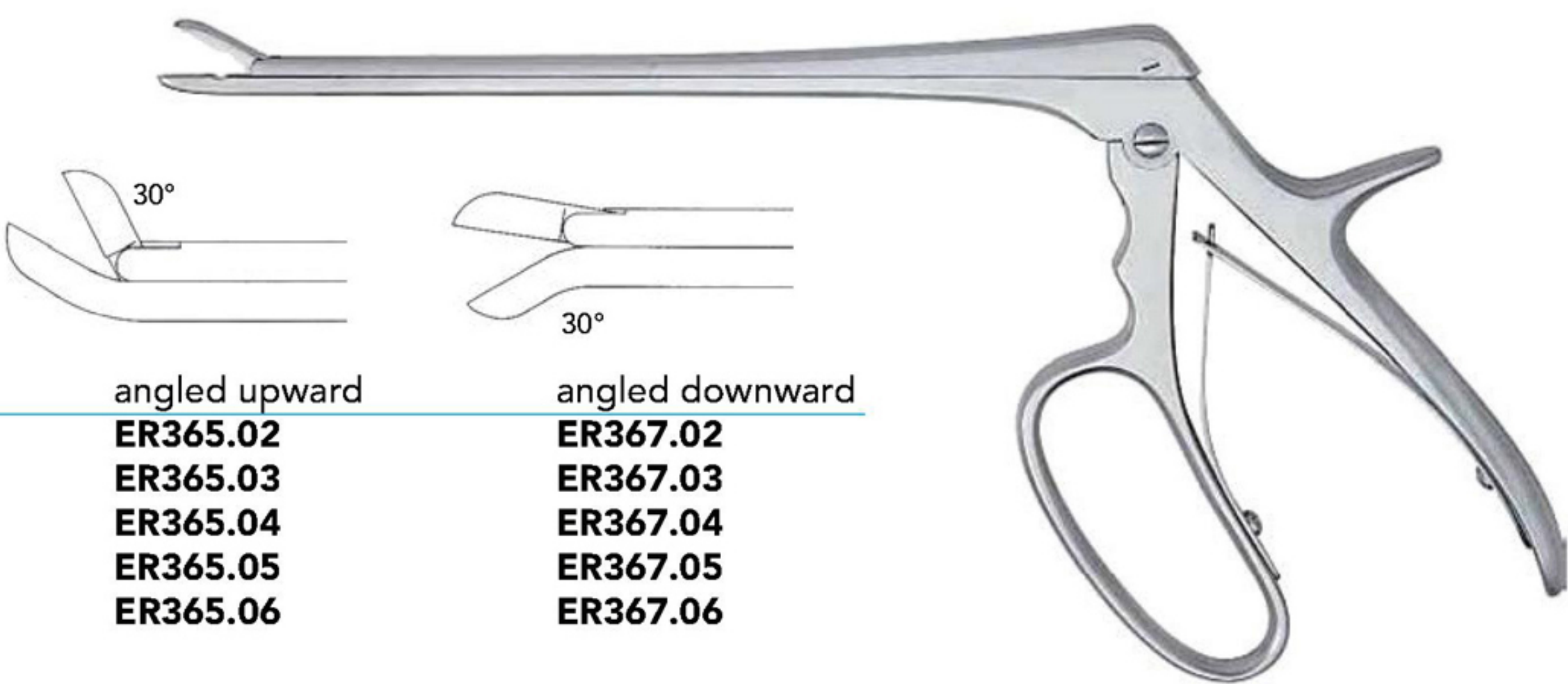

	straight	angled upward	angled downward
10 x 2 mm	ER364.02	ER365.02	ER367.02
10 x 3 mm	ER364.03	ER365.03	ER367.03
10 x 4 mm	ER364.04	ER365.04	ER367.04
10 x 5 mm	ER364.05	ER365.05	ER367.05
10 x 6 mm	ER364.06	ER365.06	ER367.06



90°
upward cutting

KERRISON

3 x 3 mm	ER389.00
4 x 4 mm	ER389.01
5 x 5 mm	ER389.02
6 x 6 mm	ER389.03

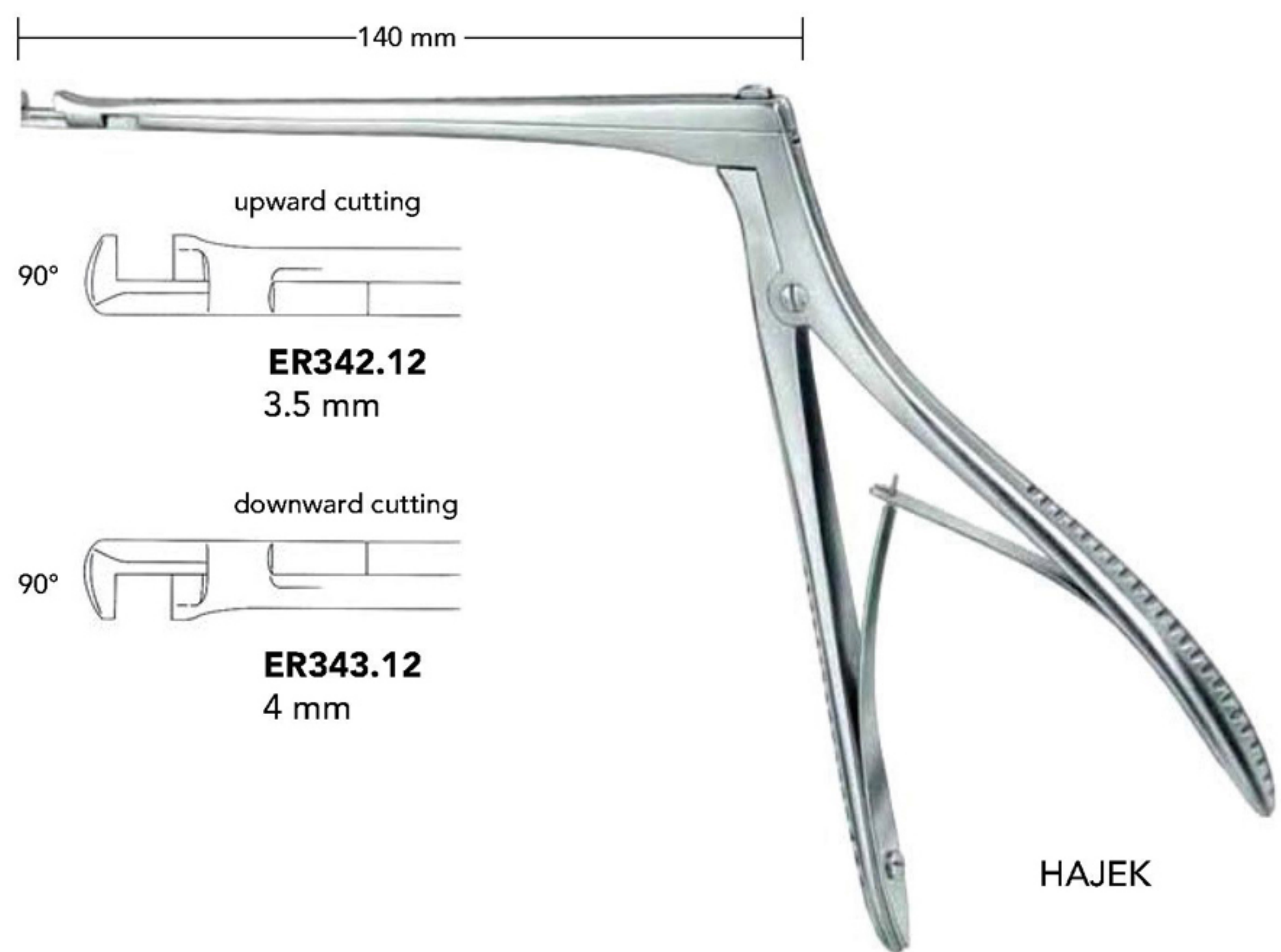

90°	upward cutting	ER342.12 3.5 mm
90°	downward cutting	ER343.12 4 mm

HAJEK

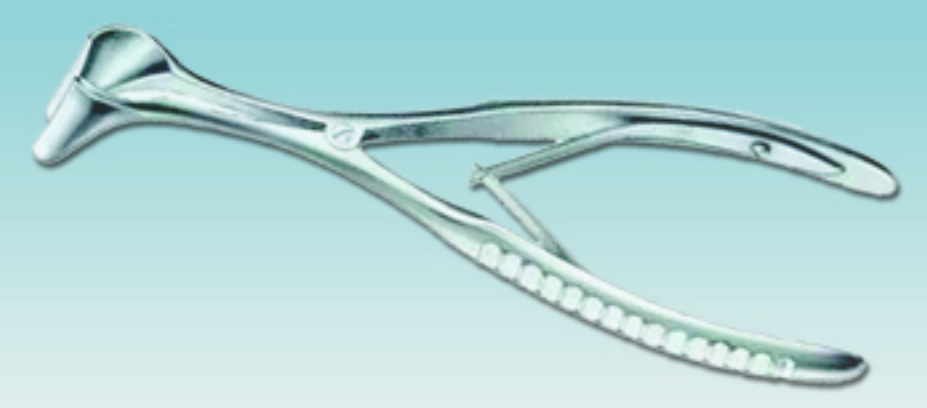

Rhinology (Septum Forceps, Septum Morselizers)

through-cutting



MIDDLETON-JANSEN
ER323.19
20.5 cm/8¼"



MIDDLETON-JANSEN
ER327.19
20 cm/8"

one toothed cutting edge



CAPLAN
ER331.20
20 cm/8"

TC Jaws



ER334.21
20 cm/8"



RUBIN
ER335.20
20 cm/8"



RUBIN
ER335.21
18.5 cm/7¼"

TC Jaws



RUBIN
ER337.21
18.5 cm/7¼"

Protection Cap



ER335.01

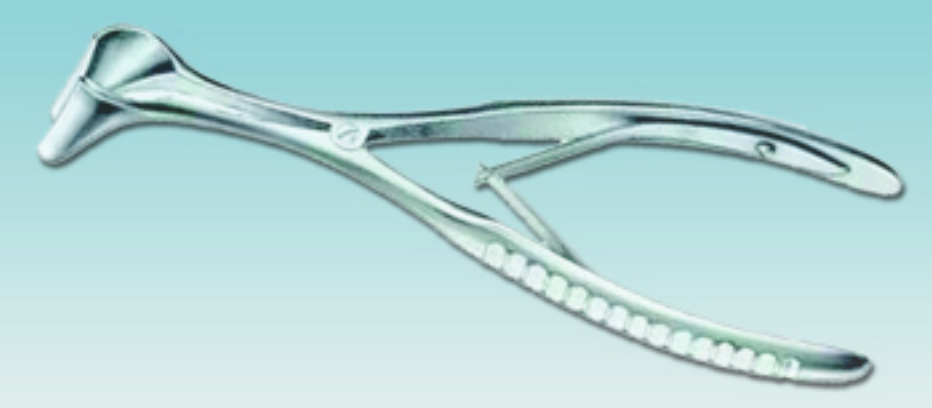



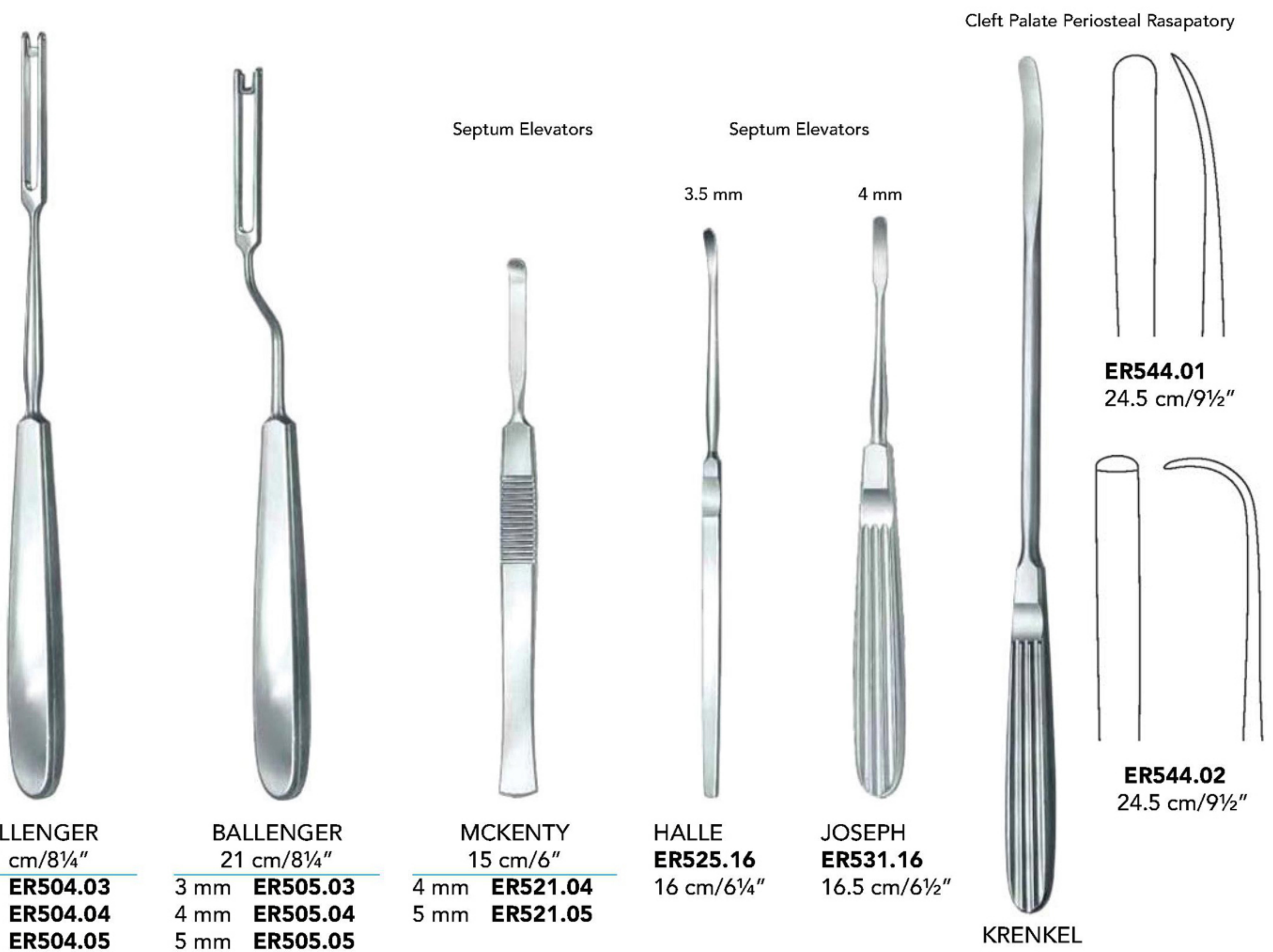
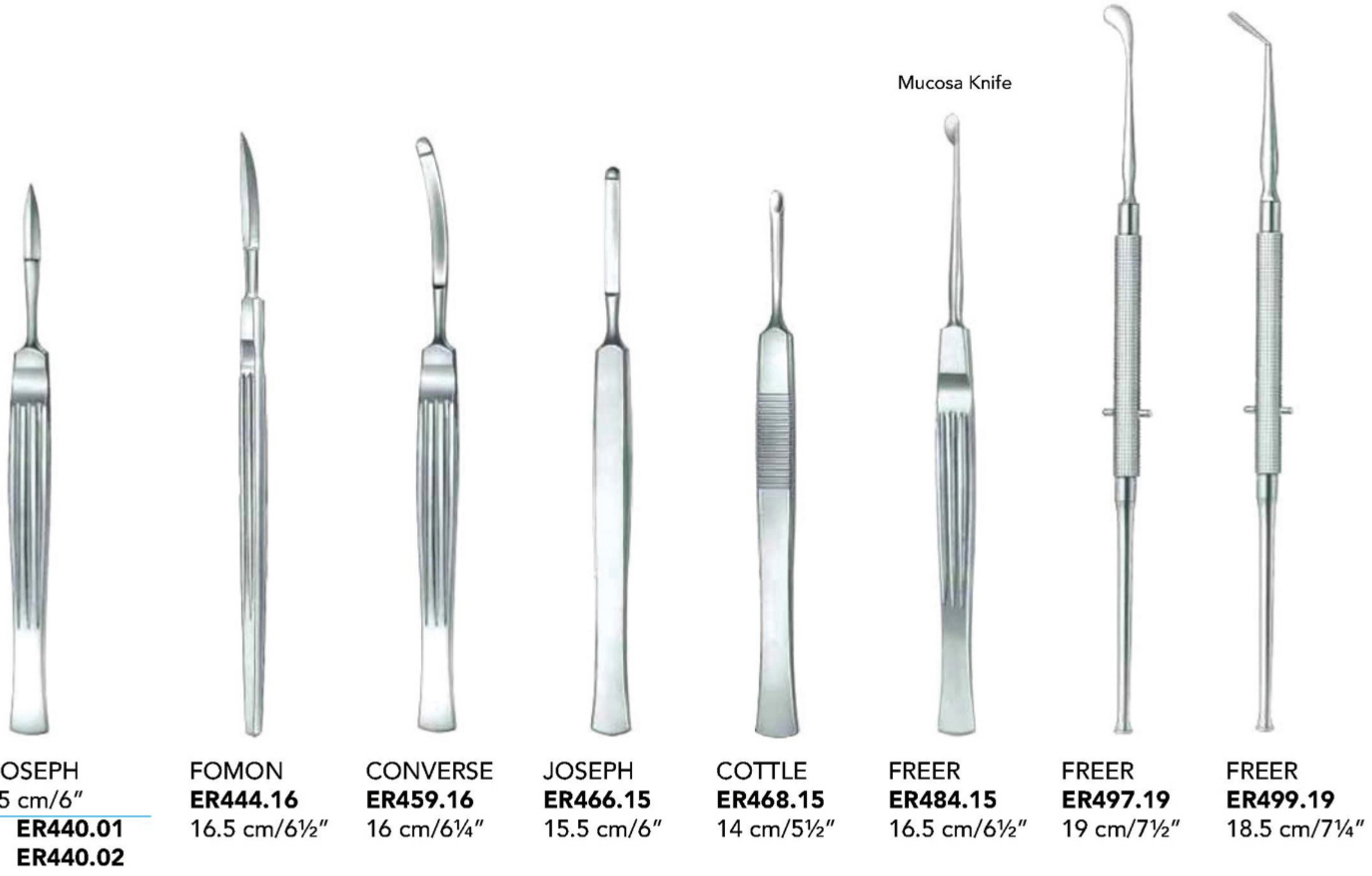

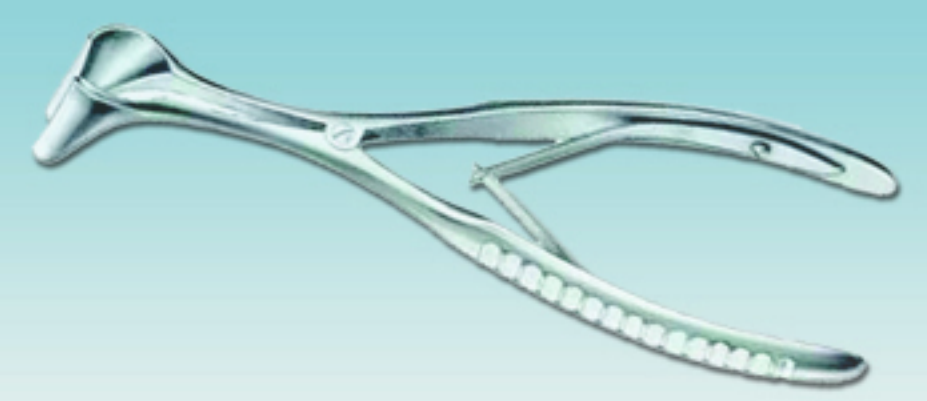









Rhinology (Rhinoplasty & Septum Knives, Swivel Knives)



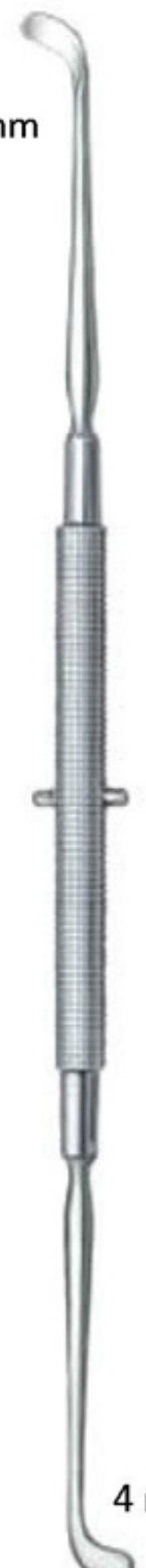

Rhinology (Septum Elevators, Periosteal Elevators)

							
5 mm	sharp/blunt 5 mm	5 mm	5 mm	4 mm	6 mm	5.5 mm	
FREER 19 cm/7½"	FREER ER545.18 18 cm/7"	FREER ER547.18 18 cm/7"	FREER ER547.20 21 cm/8¼"	MCKENTY ER549.22 20.5 cm/8"	BALLENGER-HAJEK ER550.19 19 cm/7½"	HOWARD ER557.22 21.5 cm/8½"	
sharp ER541.19							
blunt ER543.19							
							
5 mm	4 mm	4.5 mm	4 mm	4 mm	3.3 mm	4.5 mm	6.5 mm
COTTLE ER559.23 23.5 cm/9¼"	KILLIAN ER560.18 18 cm/7"	KILLIAN ER562.22 23.5 cm/9¼"	PENNINGTON ER568.21 21 cm/8"	JOSEPH-MASING ER579.22 21.5 cm/8½"	COTTLE ER581.22 23 cm/9"	COTTLE ER585.22 23 cm/9"	JOSEPH ER585.16 18 cm/7"
5 mm	4 mm	4.5 mm	4 mm		3.7 mm	4.5 mm	

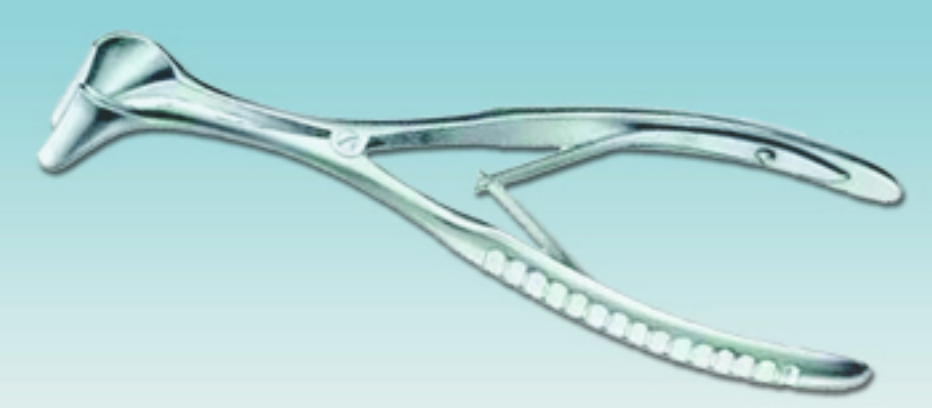

Rhinology (Septum Elevators, Periosteal Elevators)



FREER
ER593.16
16.5 cm/6½"



FREER
ER595.15
16 cm/6¼"



BALLENGER
15 cm/6"
2 mm **ER597.02**
4 mm **ER597.04**
6 mm **ER597.06**
8 mm **ER597.08**



KILLIAN
ER601.16
16 cm/6¼"



KILLIAN-CLAUS
ER605.16
16 cm/6¼"



COTTLE
18.5 cm/7¼"
4 mm **ER606.04**
7 mm **ER606.07**
9 mm **ER606.09**
12 mm **ER606.12**



COTTLE
18.5 cm/7¼"
2 mm **ER608.02**
4 mm **ER608.04**
7 mm **ER608.07**
9 mm **ER608.09**
12 mm **ER608.12**

6 mm



COTTLE
ER607.06
18.5 cm/7¼"

6 mm



COTTLE
ER609.06
18.5 cm/7¼"

16 mm



COTTLE
ER610.16
18.5 cm/7¼"

16 mm



COTTLE
ER612.16
18.5 cm/7¼"



RUBIN
18.5 cm/7¼"
10 mm **ER616.10**
12 mm **ER616.12**
14 mm **ER616.14**



WALTER
19 cm/7½"
3.0 mm **ER620.03**
4.5 mm **ER620.04**



WALTER
19 cm/7½"
3 mm **ER622.03**
4 mm **ER622.04**
7 mm **ER622.07**
9 mm **ER622.09**
12 mm **ER622.12**

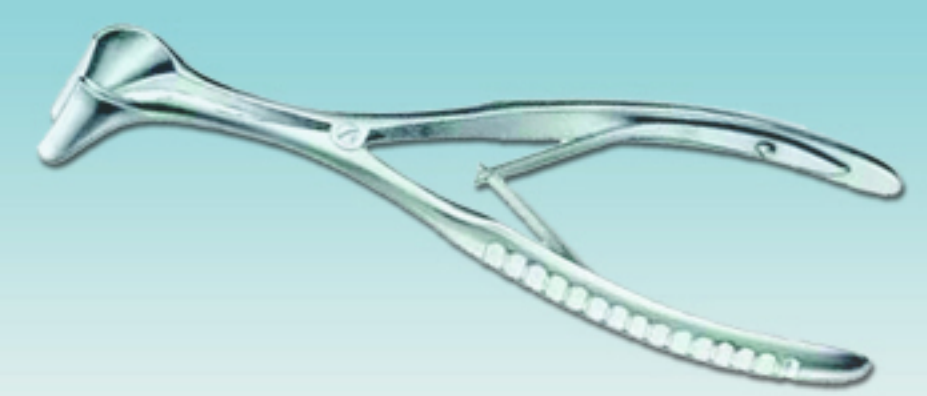

Rhinology (Rhinoplasty Chisels, Chisels)

			Right	Left		Straight	Left	Right
FOMON 16 cm/6¼"	CINELLI 16 cm/6¼"	NEIVERT-ANDERSON 20.5 cm/8"	ER625.01 7 mm	ER625.02 7 mm	LUCAS EO1000.02 3 mm EO1000.03 5 mm Gujjar/Gouges 16 cm	SILVER ER628.01 18 cm/7"	SILVER ER628.02 18 cm/7"	SILVER ER628.03 18 cm/7"
4 mm ER623.04	10 mm ER624.10			ER625.03 7 mm Straight				
5 mm ER623.05	12 mm ER624.12							
6 mm ER623.06	14 mm ER624.14							
7 mm ER623.07	16 mm ER624.16							

	Nasal Saws		Nasal Saws		Nasal Saws	
PARKES ER629.01 16 cm/6¼"	JOSEPH ER632.20 17 cm/6¾"	JOSEPH ER634.20 17 cm/6¾"	JOSEPH ER649.00 19 cm/7½"	ER649.01 40 mm working length	ER649.02	

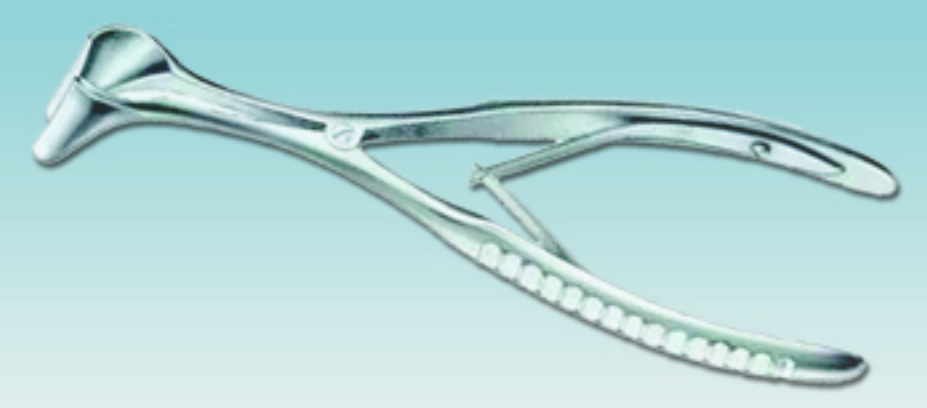

Rhinology (Nasal Rasps, Bone Files, Antrum Rasps)

34 x 7 mm



MALTZ
17 cm/6³/₄"
drawing cut **ER656.01**
pushing cut **ER656.02**

60 x 8 mm



JOSEPH
ER658.01
16 cm/6¹/₄"



GALLAHER
17 cm/6³/₄"



ER669.01
45 x 6 mm



ER669.02
45 x 6 mm



ER669.03
45 x 6 mm

Cartilage Crusher



COTTLE
ER652.00
12 cm/4³/₄"

34 x 8 mm



COTTLE
ER670.21
21 cm/8¹/₄"

32 x 9 mm



AUFRICHT
21 cm/8¹/₄"
drawing cut **ER671.21**
pushing cut **ER673.21**

15 x 8 mm



LEWIS
19 cm/7¹/₂"
drawing cut **ER674.18**
pushing cut **ER676.18**



FOMON
ER680.21
20.5 cm/8"

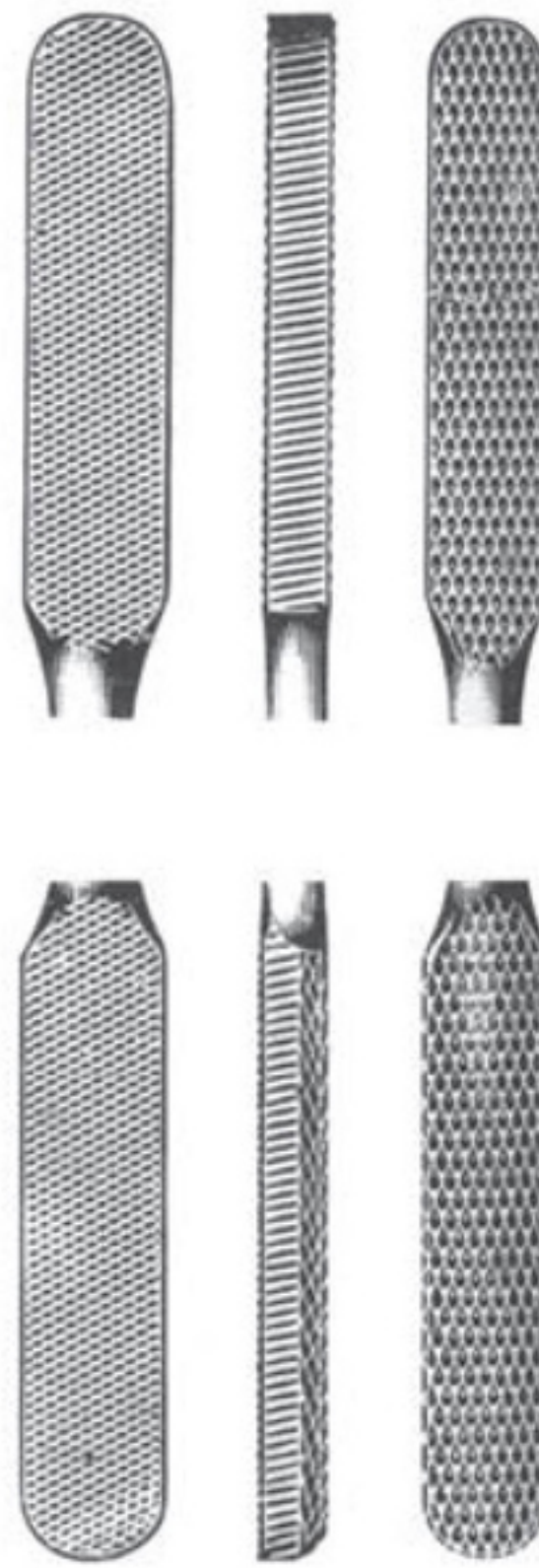

FOMON
ER1000.03
21.5 cm



FOMON
ER1000.04
21.5 cm

6.5 mm

7.5 mm

6.5 mm

7.5 mm

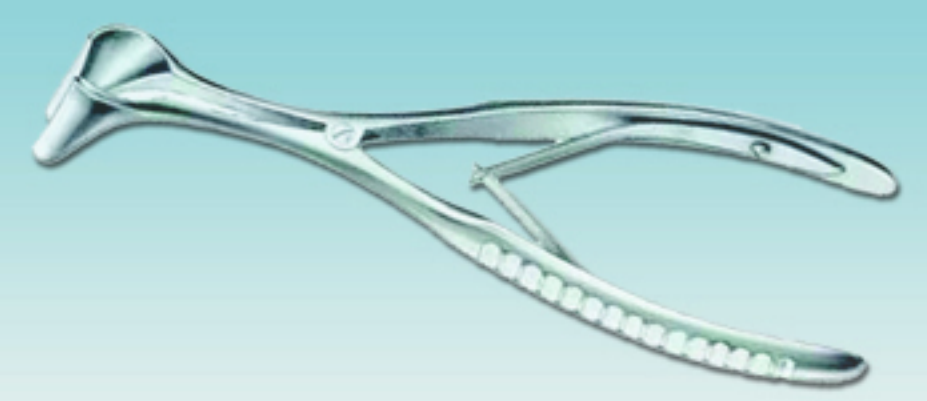

Rhinology (Nasal Raspas - TC Jaws)



MALTZ
21 cm/8¼"

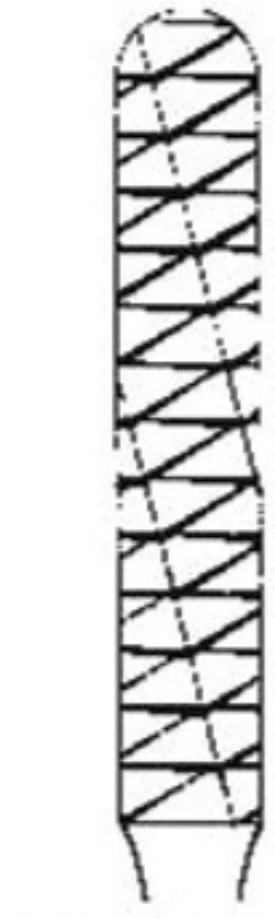

ER680.01
Fig. 1

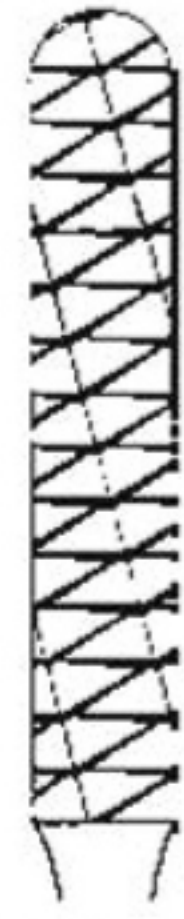

ER680.02
Fig. 2

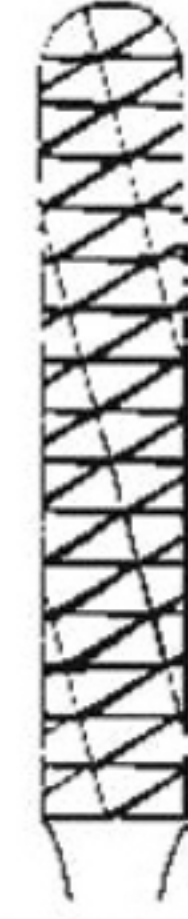

ER680.03
Fig. 3



ER680.04
Fig. 4



ER680.05
Fig. 5

TC Jaws



ER680.06
Fig. 6

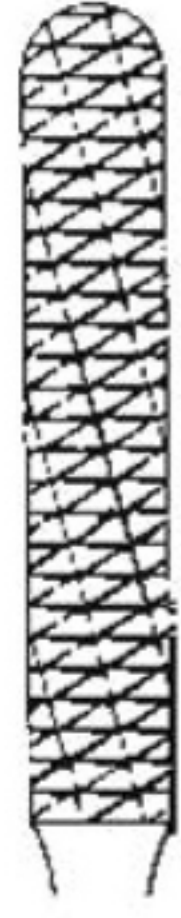

ER680.07
Fig. 7

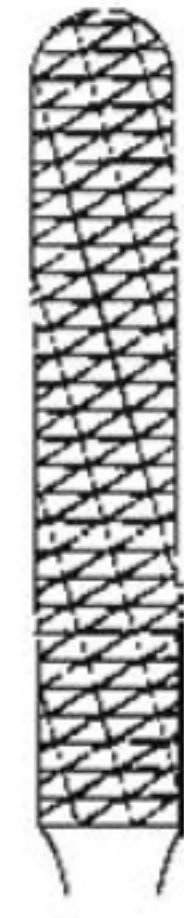

ER680.08
Fig. 8



ER680.09
Fig. 9

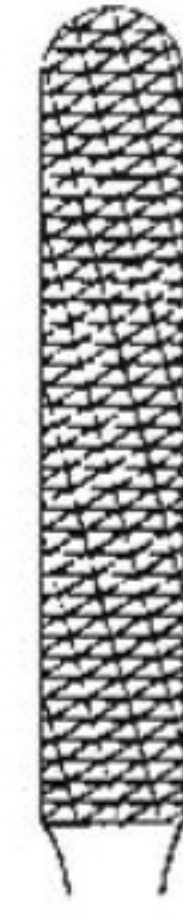

ER680.10
Fig. 10

TC Jaws

TC Jaws



FOMON
20.5 cm/8"

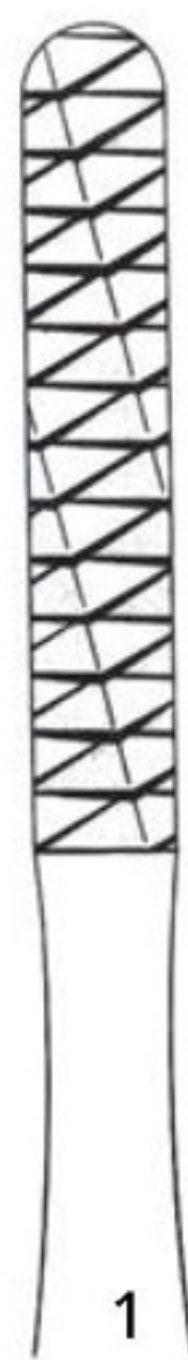

ER682.01
40 x 7 mm



ER682.03
40 x 7 mm

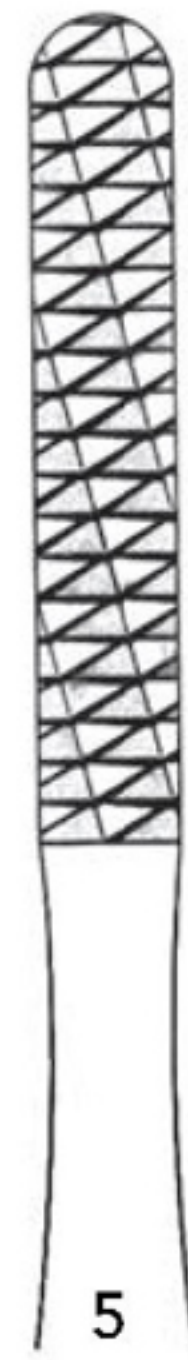

ER682.05
40 x 7 mm

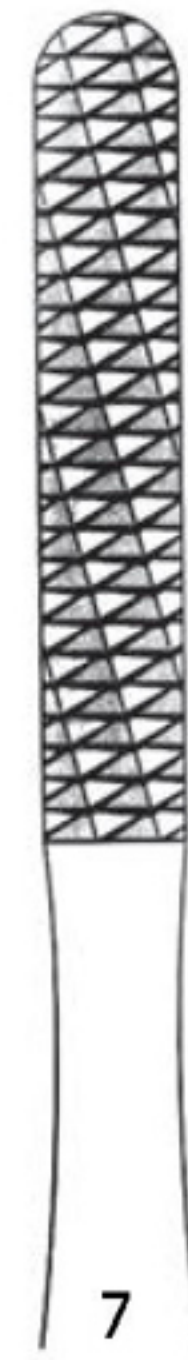

ER682.07
40 x 7 mm



ER682.09
40 x 7 mm

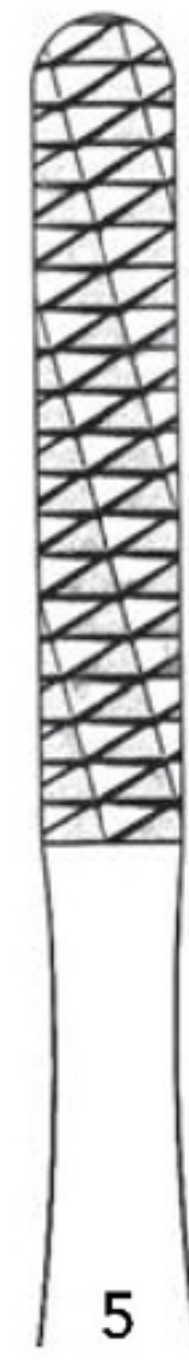

ER682.52
40 x 7 mm
special size

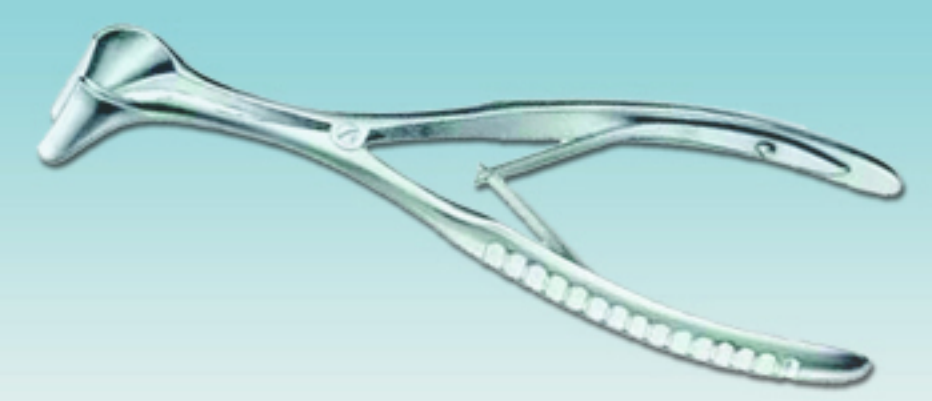

Rhinology (Nasal Hooklets, Alar & Mucosa Hooklet)

Alar Hooklet, button end

Mucosa Hooklet, sharp

sharp

sharp

ER686.16

180°

ER686.17

ER688.01 Fig. 1

ER688.02 Fig. 2

ER688.03 Fig. 3

Alar Hooklet, button end

45 x 11 mm

sharp

JOSEPH
ER684.15
15.5 cm/6"

COTTLE
ER686.16
17 cm/6¾"

COTTLE
ER686.17
17 cm/6¾"

LANGE
ER692.22
23 cm/9"

FOMON
ER694.17
17 cm/6¾"

AUFRICHT
ER697.19
19 cm/7½"

KILNER
ER698.10
8 cm/3¼"

44 x 11 mm

button end

sharp

blunt/sharp

sharp/blunt

CONVERSE
ER699.11
10.5 cm/4¼"

CONVERSE
ER700.12
11.5 cm/4½"

FREER
ER702.15
15 cm/6"

JOSEPH
16 cm/6¼"

2 mm **ER704.02**
5 mm **ER704.05**
7 mm **ER704.07**
10 mm **ER704.10**

FOMON
ER706.16
16 cm/6¼"

COTTLE-NEIVERT
ER707.20
19.5 cm/7¾"

COTTLE
ER708.14
sharp

ER709.01
blunt/sharp

ER709.02
sharp/blunt

COTTLE
19.5 cm/7¾"

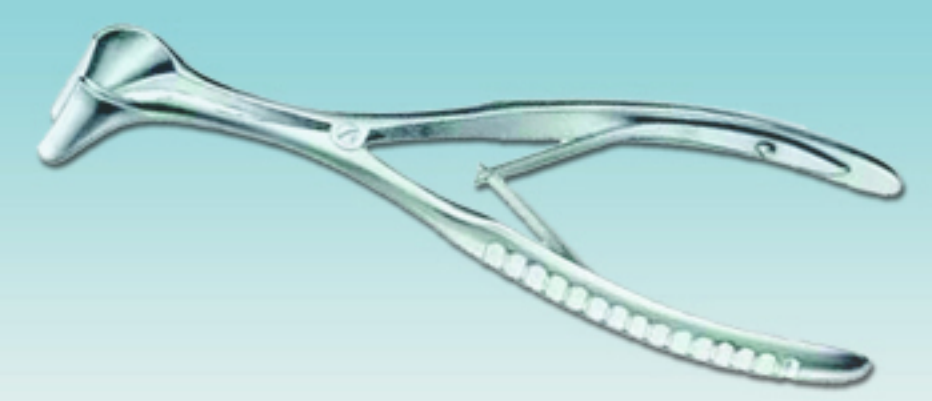

Rhinology (Nasal Retractors)

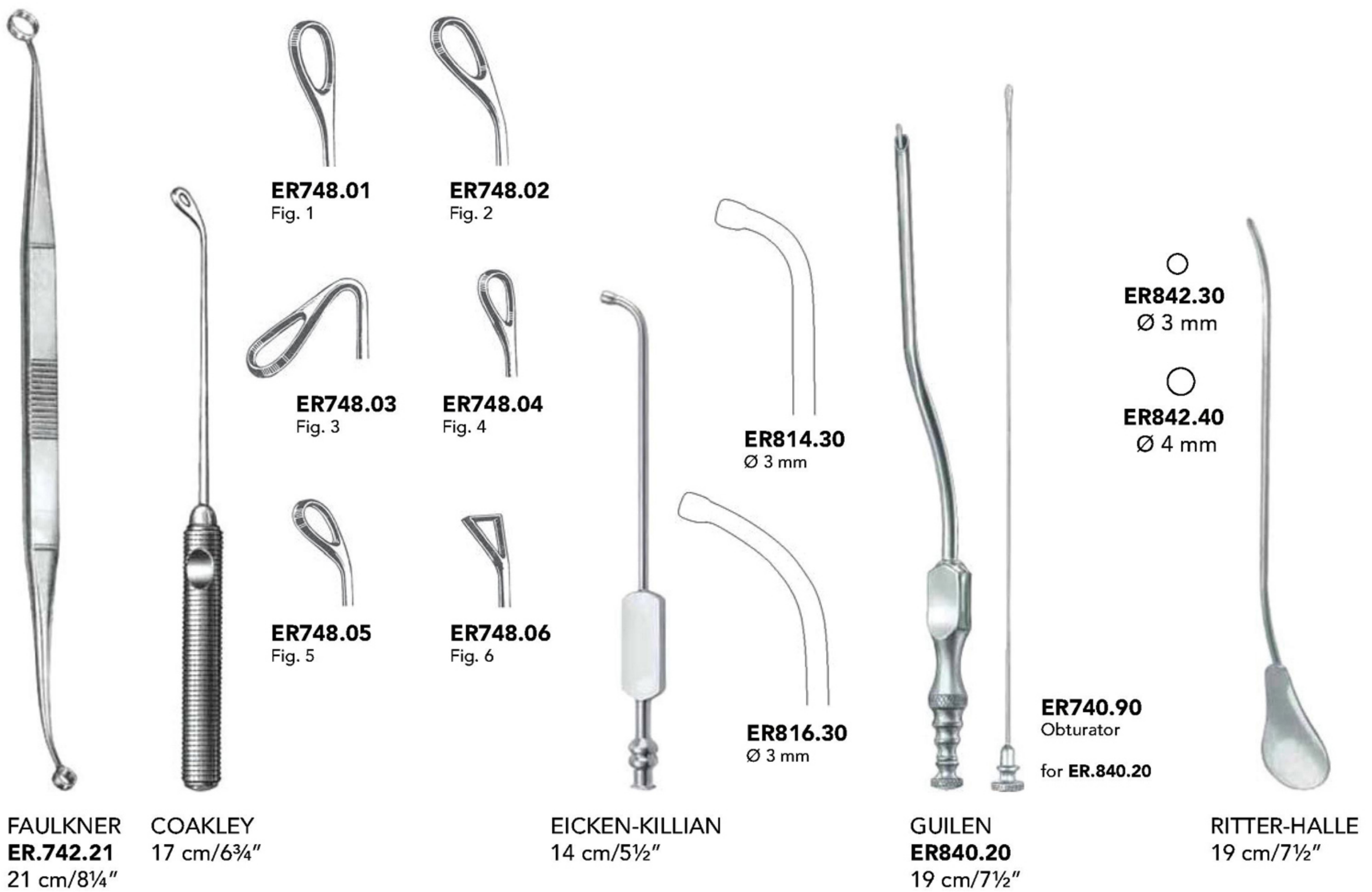
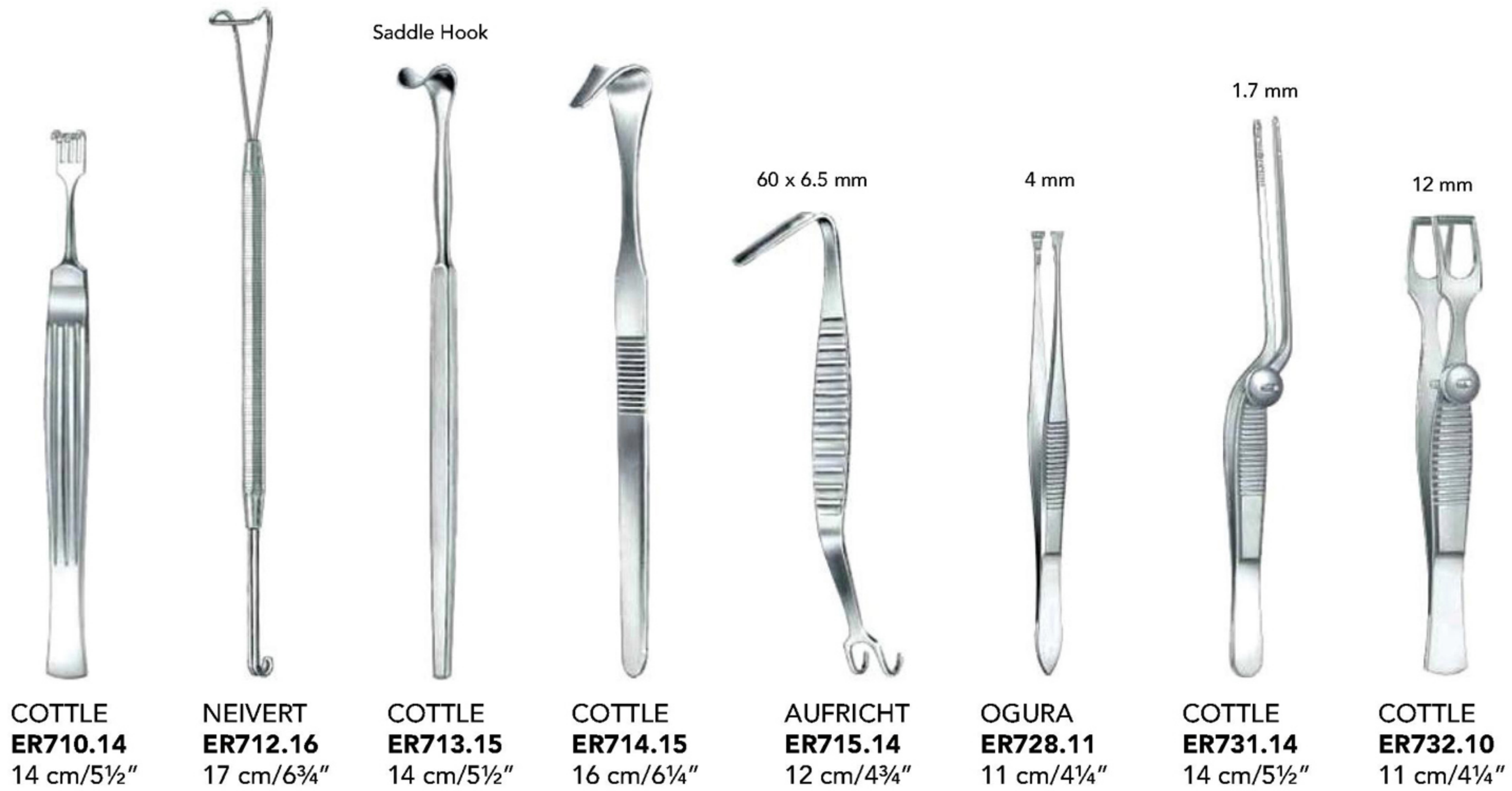

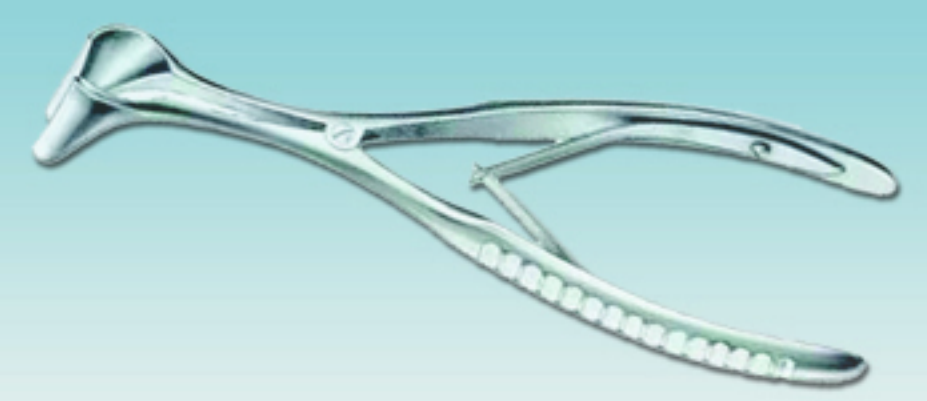

Rhinology (Septum Straightening Forceps)

Straight



ER724.01

Left



ER724.02

Right



ER724.03



KRESSNER
ER721.20
22 cm/8¾"



COTTLE-WALSHAM
23 cm/9"



ASCH
ER725.23
22.5 cm/9"

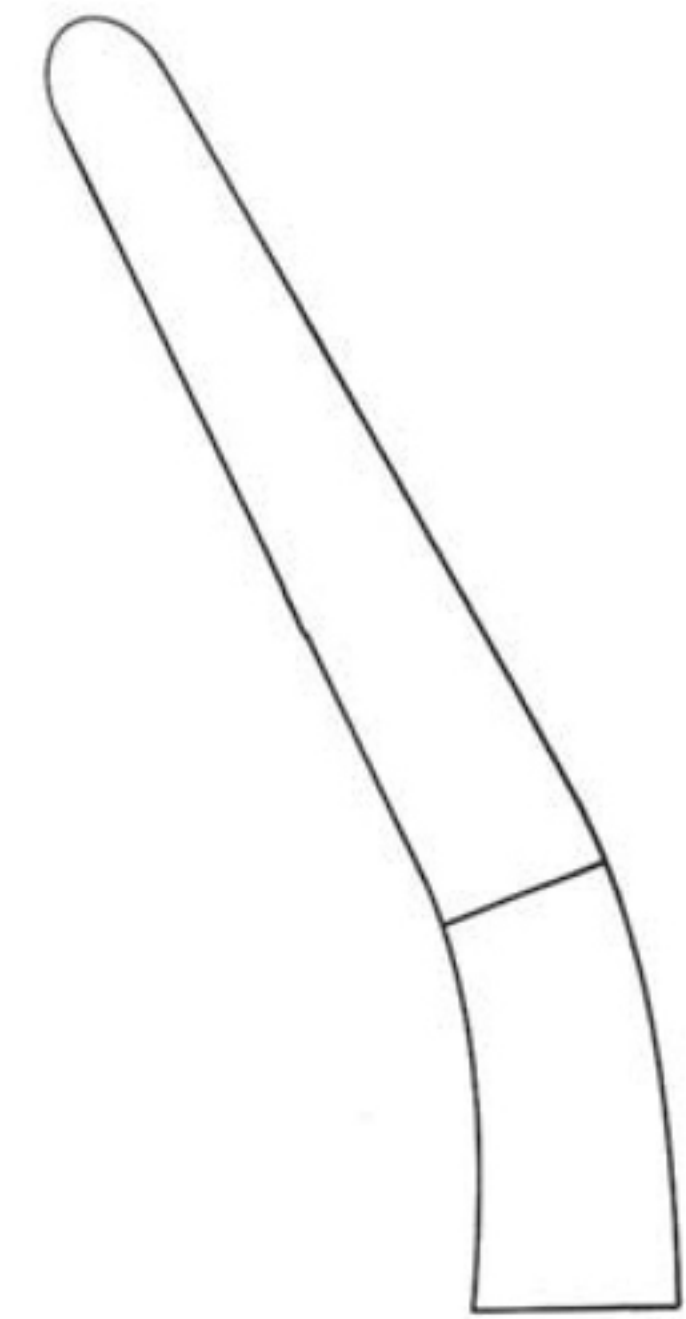

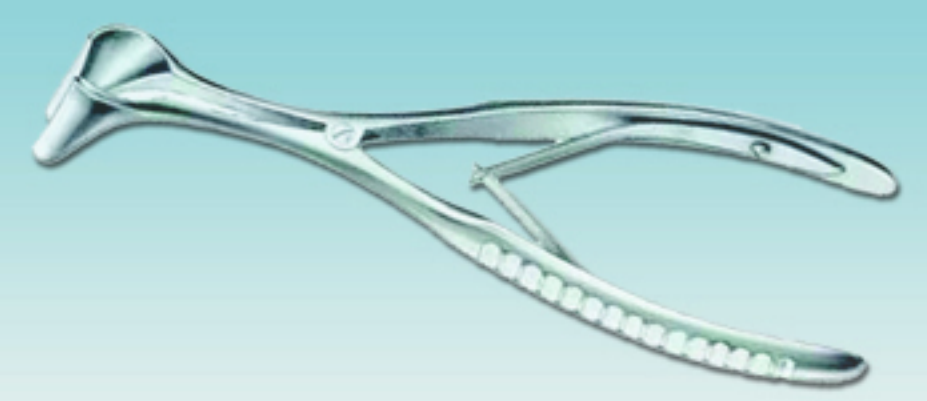

Rhinology (Adenoid Currettes)

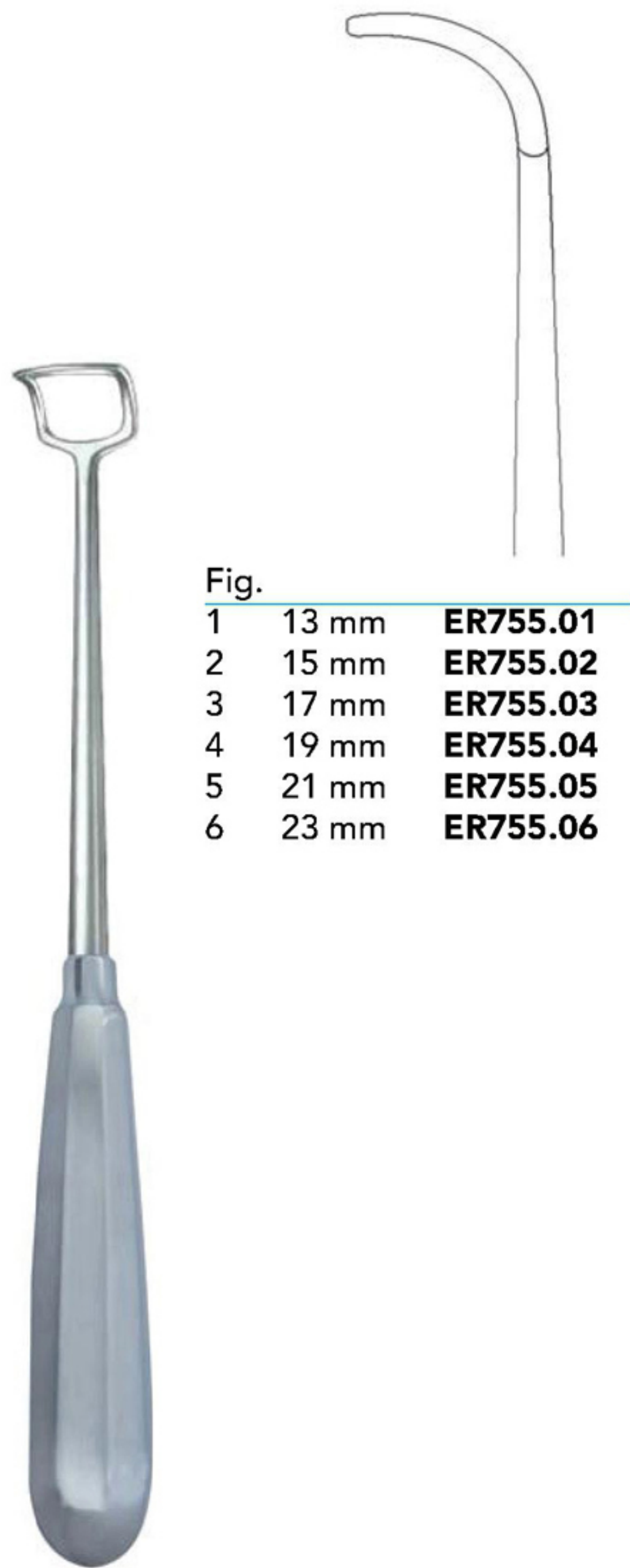

Fig.	Length	Code
1	13 mm	ER755.01
2	15 mm	ER755.02
3	17 mm	ER755.03
4	19 mm	ER755.04
5	21 mm	ER755.05
6	23 mm	ER755.06

BECKMANN
22 cm/8¾"

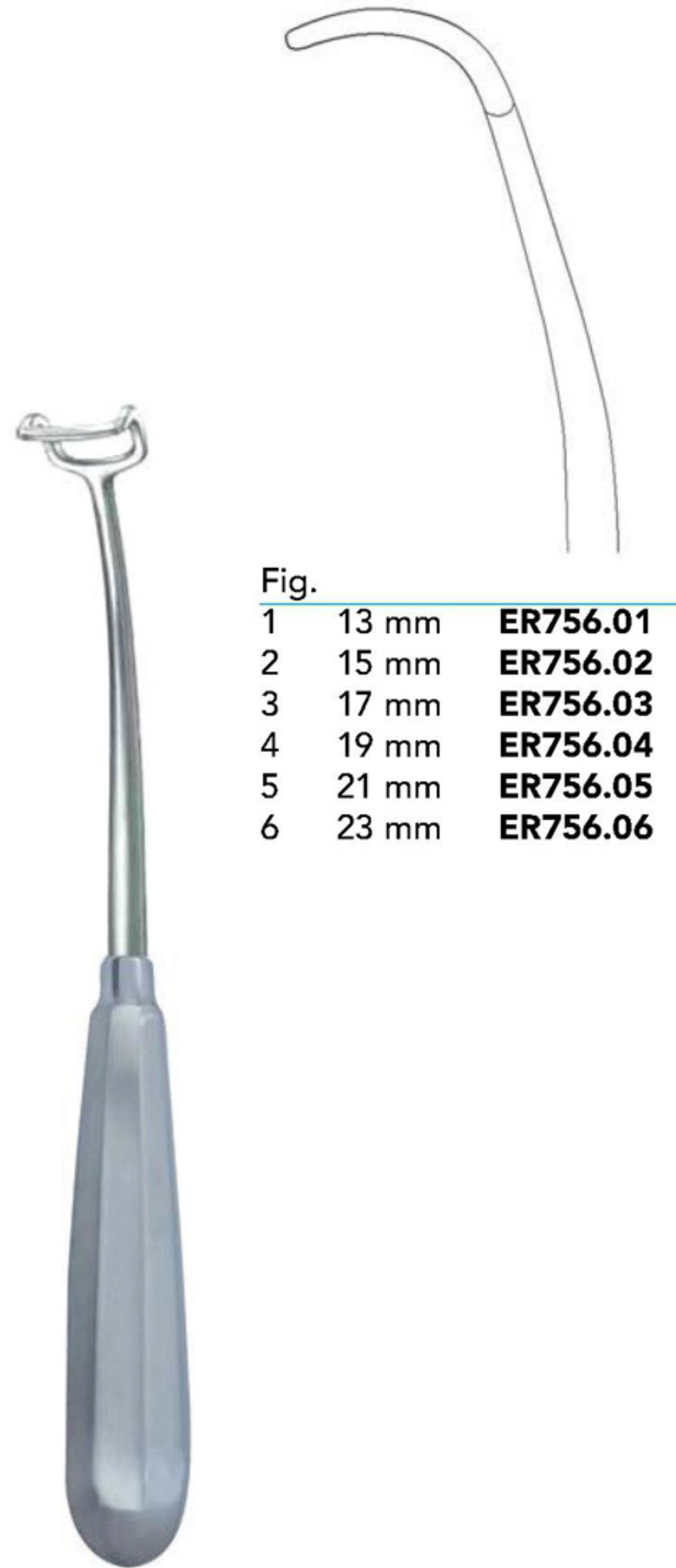

Fig.	Length	Code
1	13 mm	ER756.01
2	15 mm	ER756.02
3	17 mm	ER756.03
4	19 mm	ER756.04
5	21 mm	ER756.05
6	23 mm	ER756.06

BECKMANN
21.5 cm/8½"