

## Scissors (Operating Scissors)

Blunt/Blunt

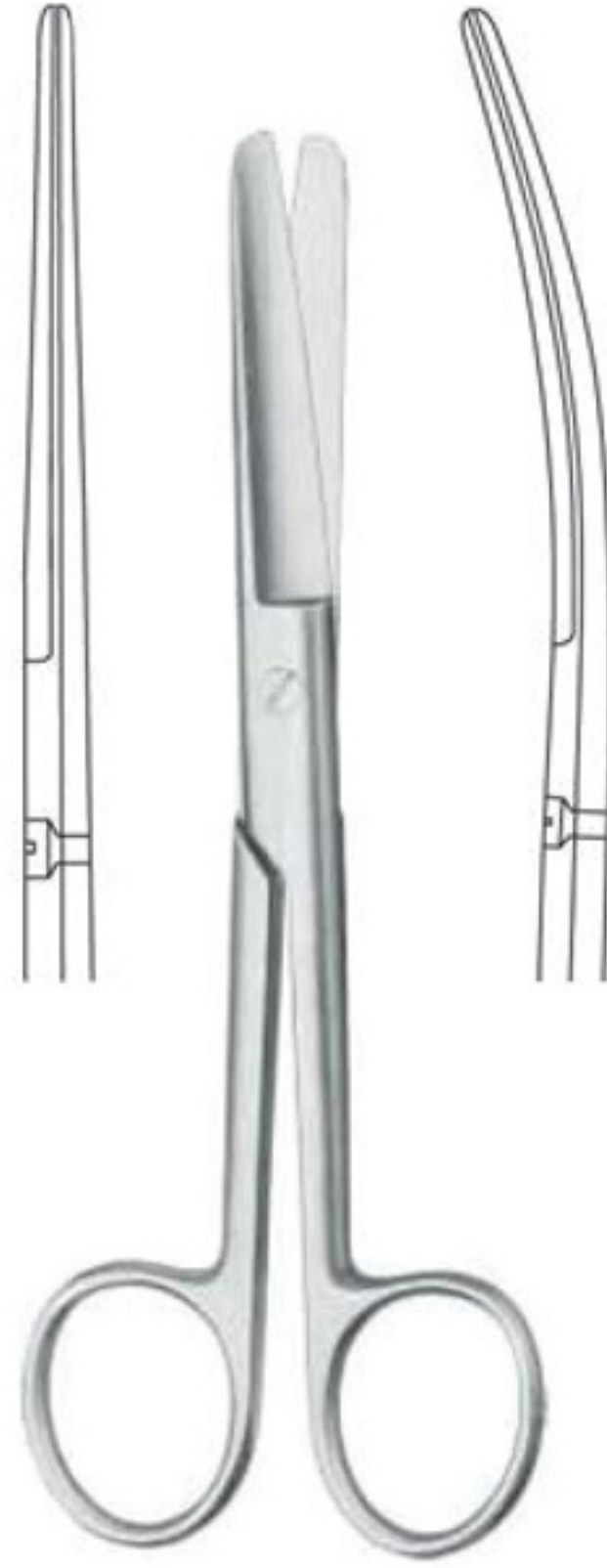

STANDARD

	Straight	Curved
12.0 cm/4¾"	<b>GS100.11</b>	<b>GS105.11</b>
13.0 cm/5"	<b>GS100.13</b>	<b>GS105.13</b>
14.5 cm/5¾"	<b>GS100.14</b>	<b>GS105.14</b>
15.5 cm/6¼"	<b>GS100.15</b>	<b>GS105.15</b>
16.5 cm/6½"	<b>GS100.16</b>	<b>GS105.16</b>
17.5 cm/7"	<b>GS100.17</b>	<b>GS105.17</b>
18.5 cm/7¼"	<b>GS100.18</b>	<b>GS105.18</b>
20.5 cm/8"	<b>GS100.20</b>	<b>GS105.20</b>

Blunt/Sharp

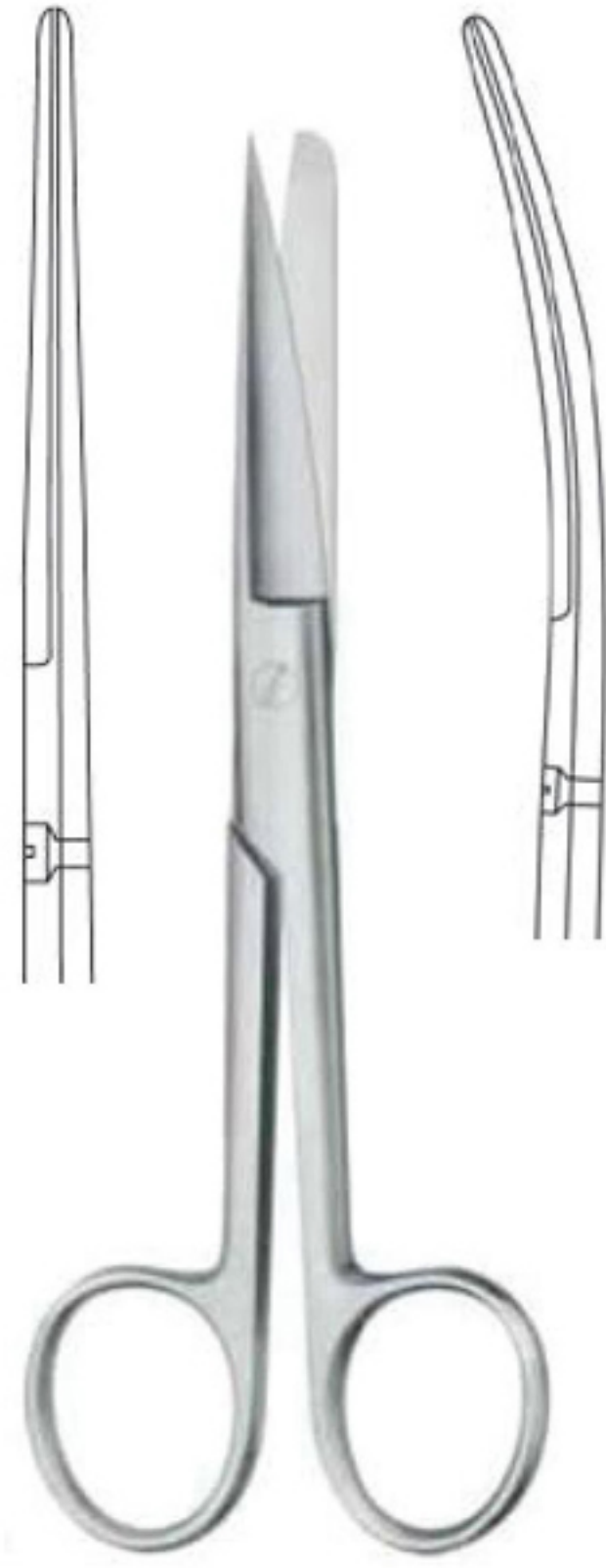

STANDARD

	Straight	Curved
12.0 cm/4¾"	<b>GS102.11</b>	<b>GS107.11</b>
13.0 cm/5"	<b>GS102.13</b>	<b>GS107.13</b>
14.5 cm/5¾"	<b>GS102.14</b>	<b>GS107.14</b>
15.5 cm/6¼"	<b>GS102.15</b>	<b>GS107.15</b>
16.5 cm/6½"	<b>GS102.16</b>	<b>GS107.16</b>
17.5 cm/7"	<b>GS102.17</b>	<b>GS107.17</b>
18.5 cm/7¼"	<b>GS102.18</b>	<b>GS107.18</b>
20.5 cm/8"	<b>GS102.20</b>	<b>GS107.20</b>

Sharp/Sharp

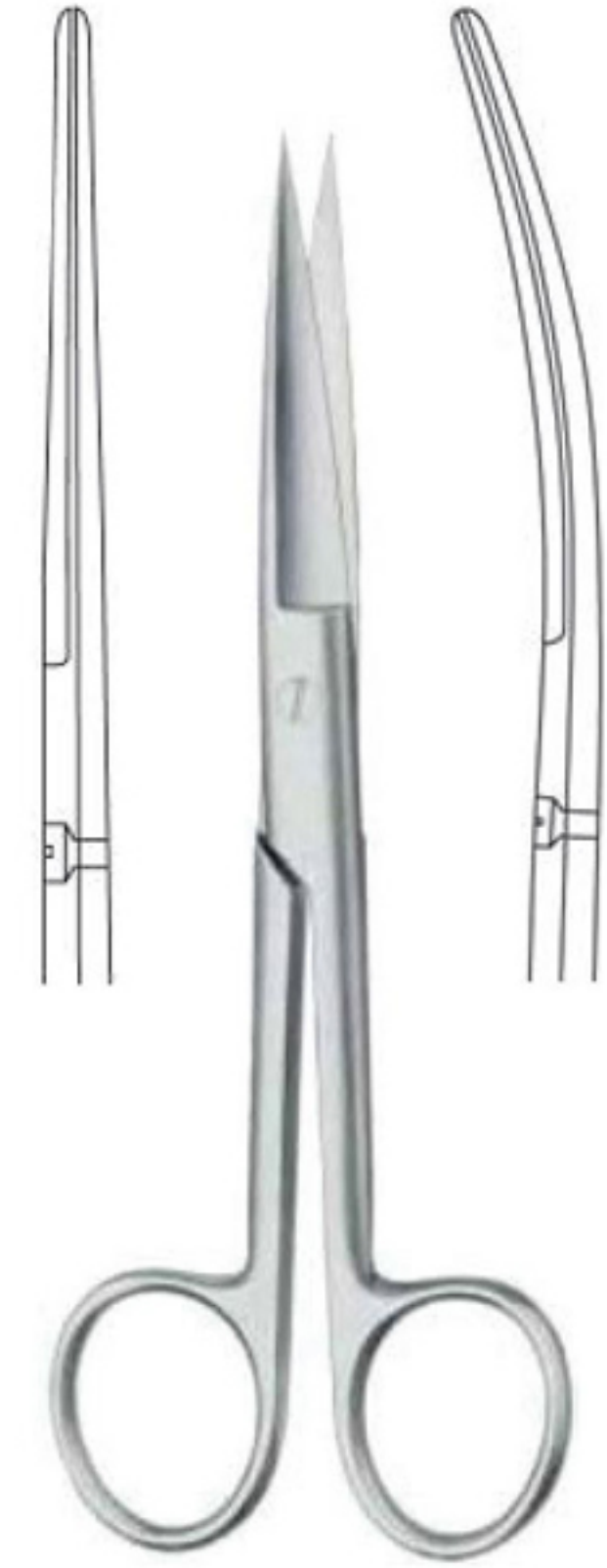

STANDARD

	Straight	Curved
12.0 cm/4¾"	<b>GS104.11</b>	<b>GS109.11</b>
13.0 cm/5"	<b>GS104.13</b>	<b>GS109.13</b>
14.5 cm/5¾"	<b>GS104.14</b>	<b>GS109.14</b>
15.5 cm/6¼"	<b>GS104.15</b>	<b>GS109.15</b>
16.5 cm/6½"	<b>GS104.16</b>	<b>GS109.16</b>

TC Edge



STANDARD

	Straight	Curved
14.5 cm/5¾"	<b>GS902.14</b>	<b>GS903.14</b>

SuperCut



STANDARD

	Straight	Curved
	<b>GS650.14</b>	<b>GS651.14</b>

TC Edge



STANDARD

	Straight	Curved
	<b>GS904.14</b>	<b>GS905.14</b>

TC Edge

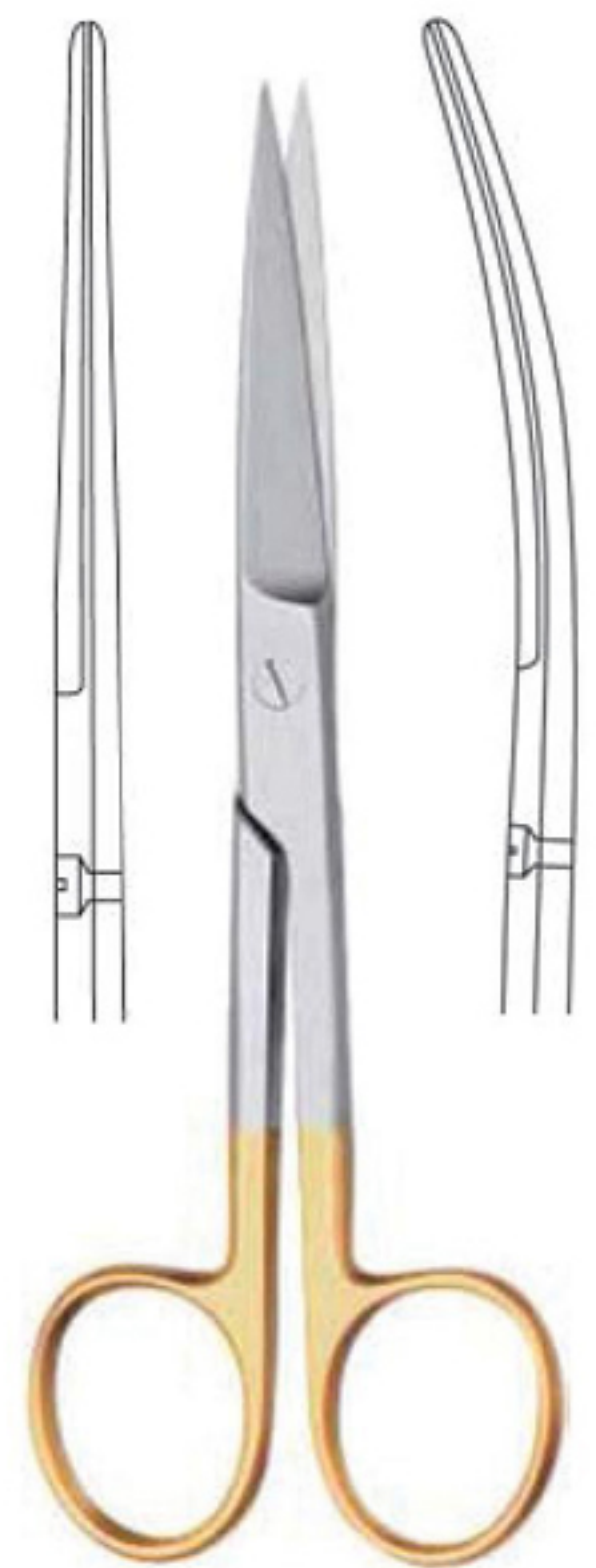

STANDARD

	Straight	Curved
	<b>GS906.14</b>	<b>GS907.14</b>



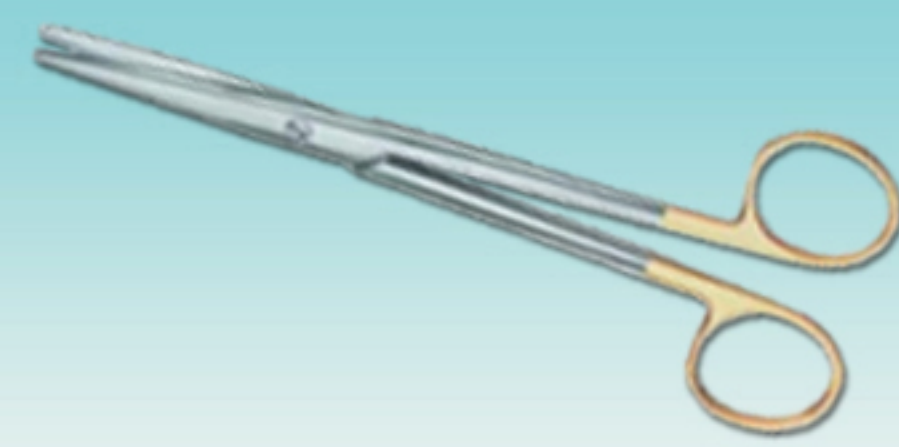

## Scissors (Dissecting Scissors)

Delicate scissors



13.0 cm/5"	Blunt/Blunt	<b>GS120.13</b>
14.5 cm/5¾"	Blunt/Blunt	<b>GS120.14</b>
13.0 cm/5"	Sharp/Blunt	<b>GS122.13</b>
14.5 cm/5¾"	Sharp/Blunt	<b>GS122.14</b>
13.0 cm/5"	Sharp/Sharp	<b>GS124.13</b>
14.5 cm/5¾"	Sharp/Sharp	<b>GS124.14</b>

Incision scissors



13.0 cm/5"	Blunt/Blunt	<b>GS125.13</b>
14.5 cm/5¾"	Blunt/Blunt	<b>GS125.14</b>
13.0 cm/5"	Sharp/Blunt	<b>GS127.13</b>
14.5 cm/5¾"	Sharp/Blunt	<b>GS127.14</b>
13.0 cm/5"	Sharp/Sharp	<b>GS129.13</b>
14.5 cm/5¾"	Sharp/Sharp	<b>GS129.14</b>



**GS136.14**  
14.5 cm/5¾"



DEAVER  
**GS142.15**  
14.5 cm/5¾"

TC Edge

SuperCut



DEAVER  
14 cm/5½"

Straight	Curved
<b>GS140.14</b>	<b>GS141.14</b>

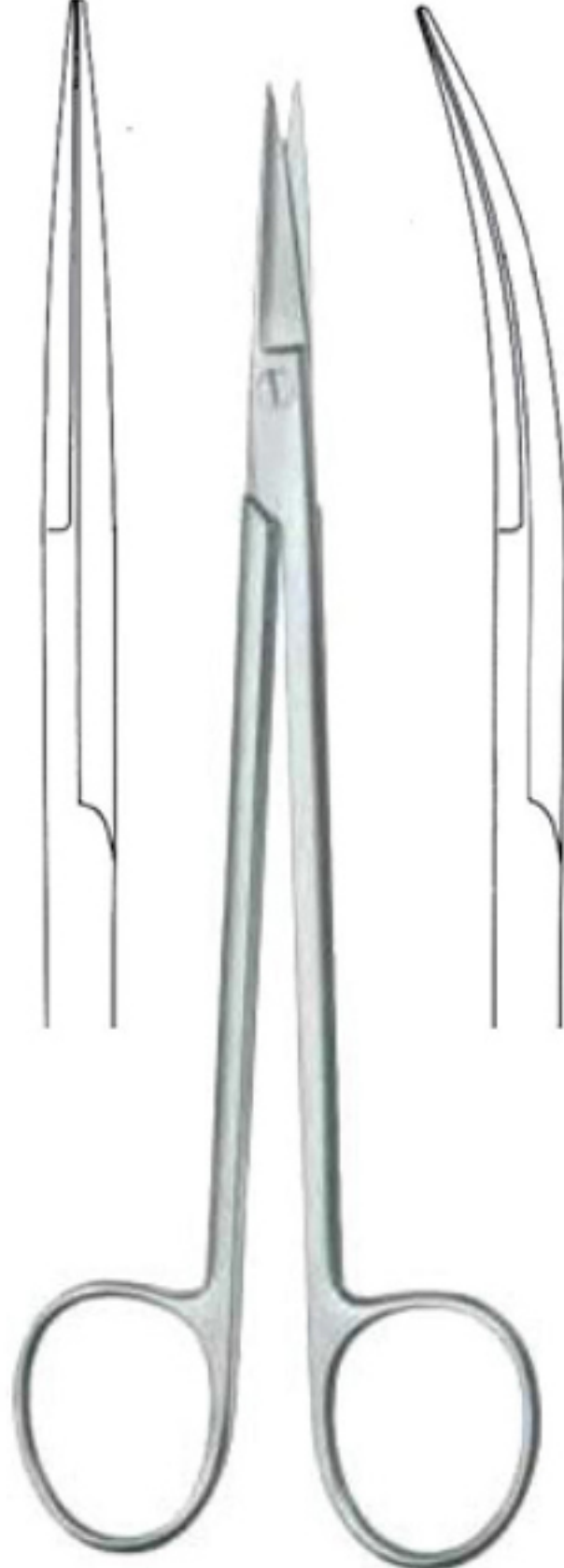

KELLY  
16 cm/6¼"

Straight	Curved
<b>GS226.16</b>	<b>GS227.16</b>

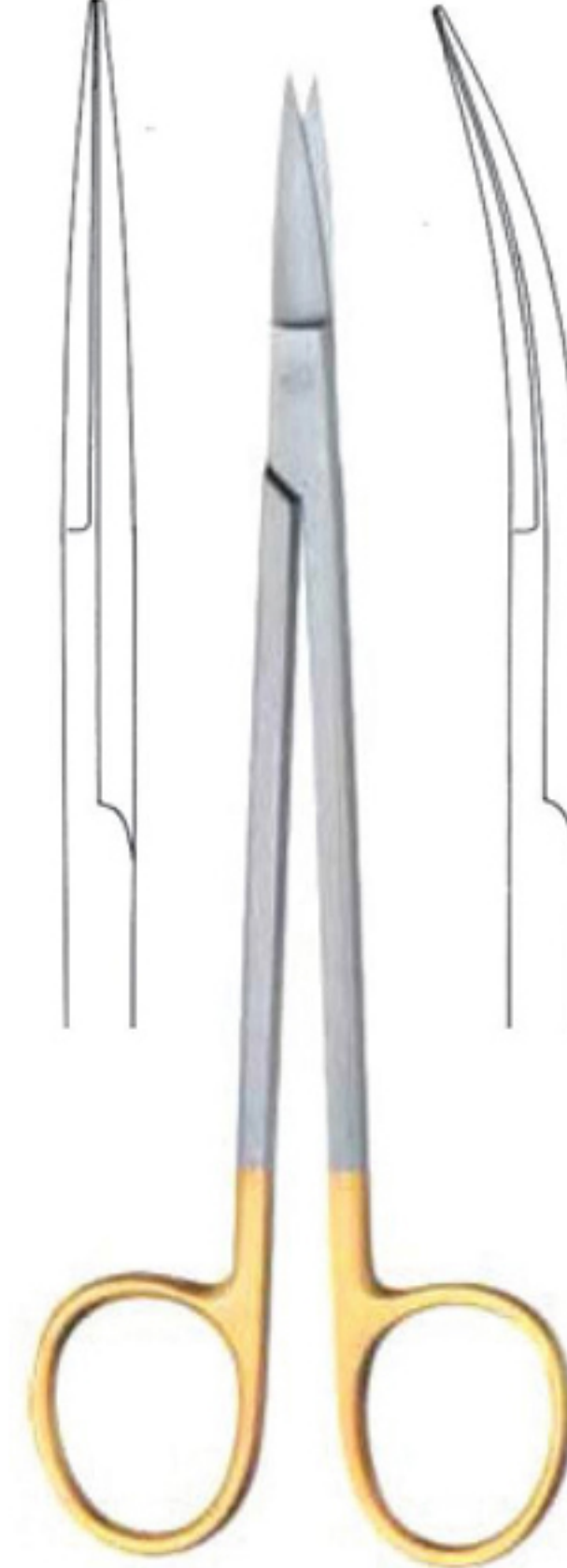

KELLY  
16 cm/6¼"

Straight	Curved
<b>GS992.16</b>	<b>GS993.16</b>

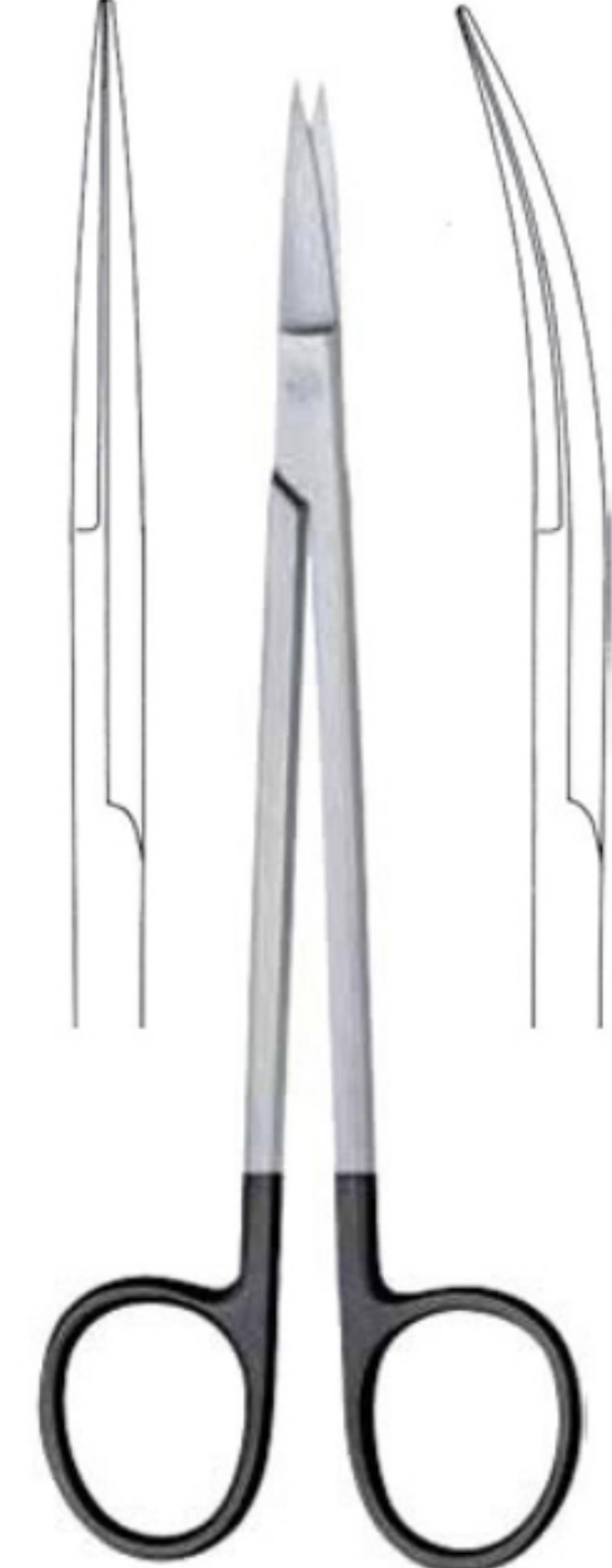

KELLY  
16 cm/6¼"

Straight	Curved
<b>GS656.16</b>	<b>GS657.16</b>



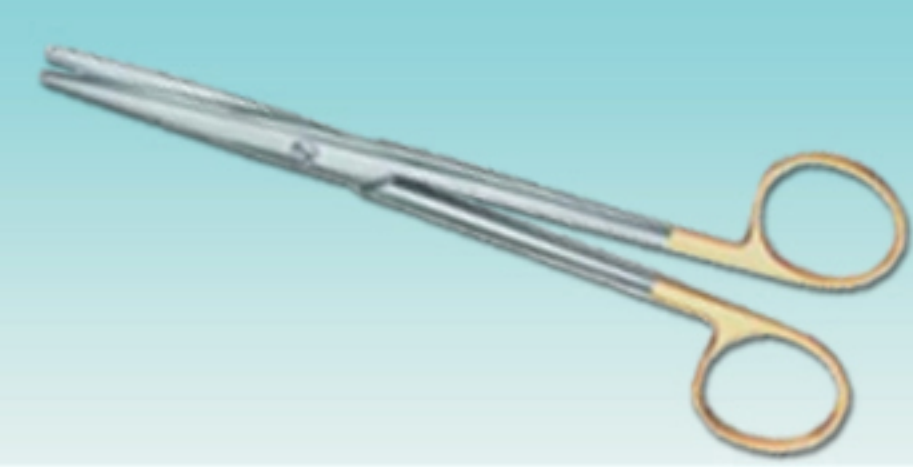

## Scissors (Dissecting Scissor)



MAYO

	Straight	Curved
14.5 cm/5¾"	<b>GS170.14</b>	<b>GS171.14</b>
15.5 cm/6¼"	<b>GS170.15</b>	<b>GS171.15</b>
17.0 cm/6¾"	<b>GS170.17</b>	<b>GS171.17</b>
23.5 cm/9¼"	<b>GS170.23</b>	<b>GS171.23</b>

TC Edge



MAYO

	Straight	Curved
14.5 cm/5¾"	<b>GS910.14</b>	<b>GS911.14</b>
17.0 cm/6¾"	<b>GS910.17</b>	<b>GS911.17</b>
23.5 cm/9¼"	<b>GS910.23</b>	<b>GS911.23</b>

SuperCut



MAYO

	Straight	Curved
14.5 cm/5¾"	<b>GS652.14</b>	<b>GS653.14</b>
17.0 cm/6¾"	<b>GS652.17</b>	<b>GS653.17</b>
23.5 cm/9¼"	<b>GS652.23</b>	<b>GS653.23</b>



MAYO STILLE

	Straight	Curved
15.0 cm/6"	<b>GS180.15</b>	<b>GS181.15</b>
17.0 cm/6¾"	<b>GS180.17</b>	<b>GS181.17</b>

TC Edge



MAYO STILLE

	Straight	Curved
15.0 cm/6"	<b>GS930.15</b>	<b>GS931.15</b>
17.0 cm/6¾"	<b>GS930.17</b>	<b>GS931.17</b>

SuperCut



MAYO STILLE

	Straight	Curved
15.0 cm/6"	<b>GS654.15</b>	<b>GS655.15</b>
17.0 cm/6¾"	<b>GS654.17</b>	<b>GS655.17</b>



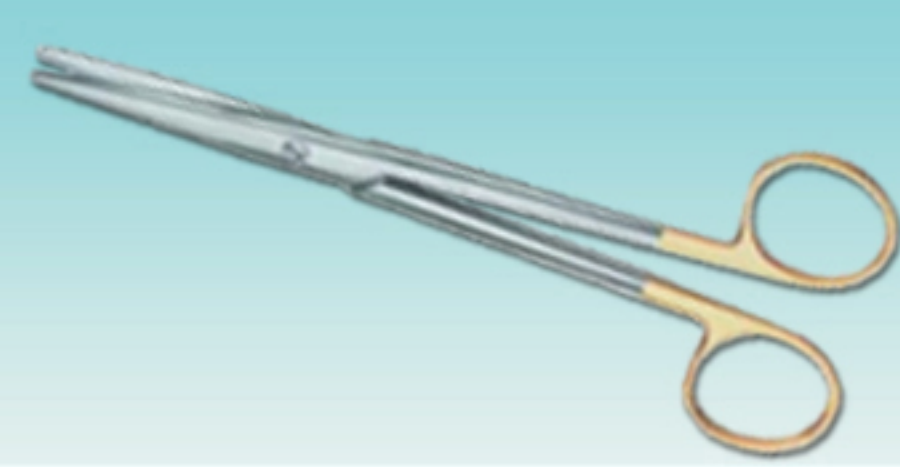

## Scissors (Dissecting Scissors)

One toothed cutting edge



MAYO

14.5 cm/5¾"	<b>GS915.14</b>
17.0 cm/6¾"	<b>GS915.17</b>
23 cm/9"	<b>GS915.23</b>

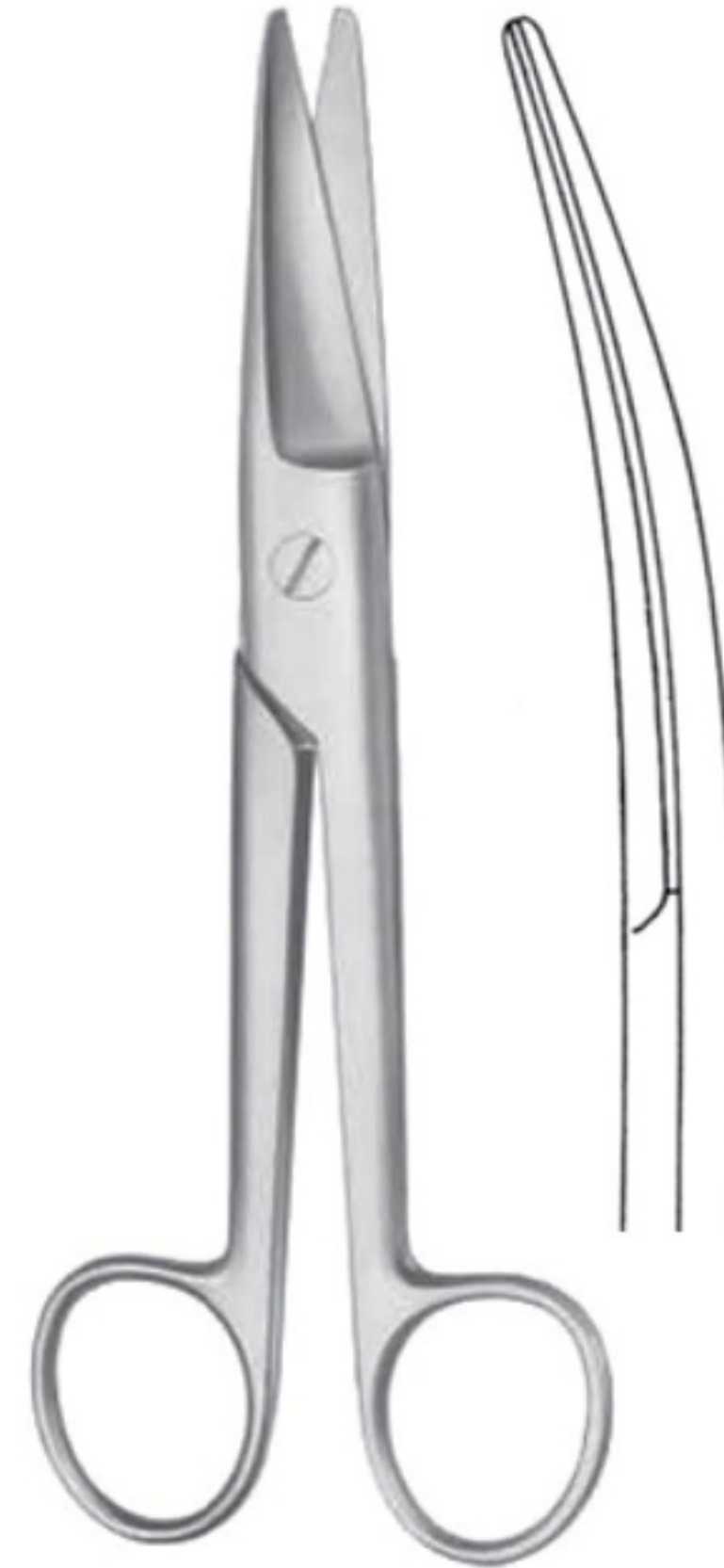

MAYO-NOBLE

	Straight	Curved
17.0 cm/6¾"	<b>GS190.17</b>	<b>GS191.17</b>

TC Edge



MAYO-LEXER

16 cm/6¼"	<b>GS953.16</b>
-----------	-----------------

Dissecting scissors

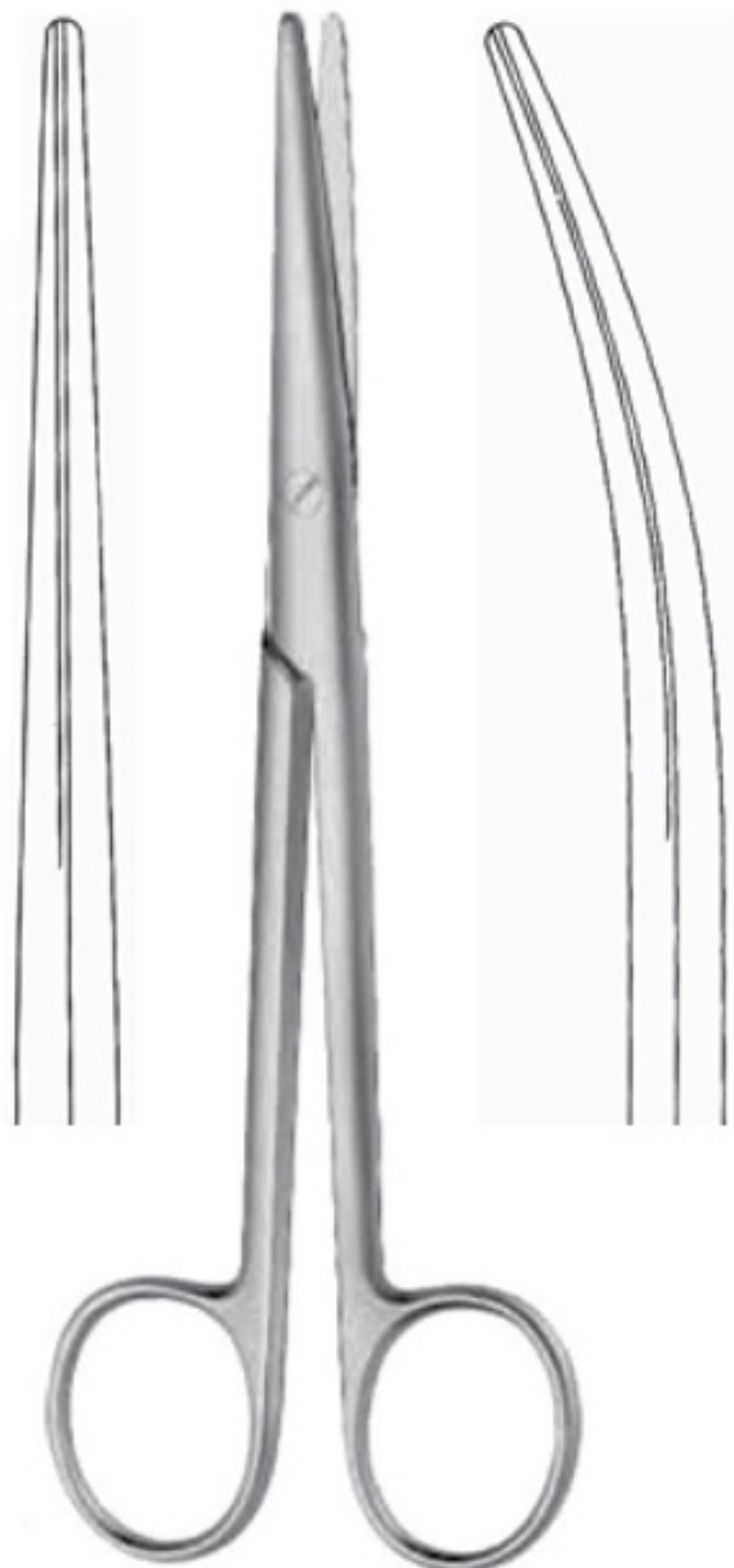

MAYO STILLE

	Straight	Curved
16 cm/6¼"	<b>GS184.16</b>	<b>GS185.16</b>
19.5 cm/7¾"	<b>GS184.19</b>	<b>GS185.19</b>
21.5 cm/8½"	<b>GS184.21</b>	<b>GS185.21</b>

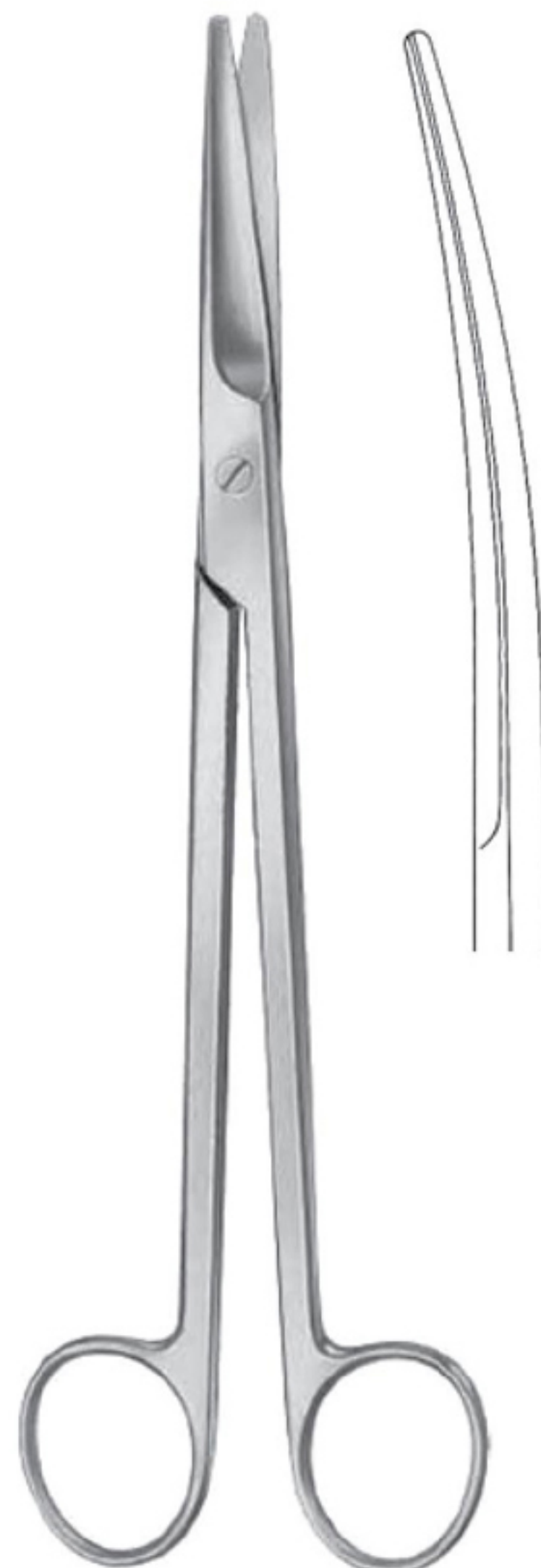

MAYO-HARRINGTON

	Straight	Curved
23 cm/9"	<b>GS174.22</b>	<b>GS175.22</b>
28 cm/11"		<b>GS175.30</b>

One toothed cutting edge



METZENBAUM

	Straight	Curved
14.5 cm/5¾"	<b>GS298.14</b>	<b>GS299.14</b>



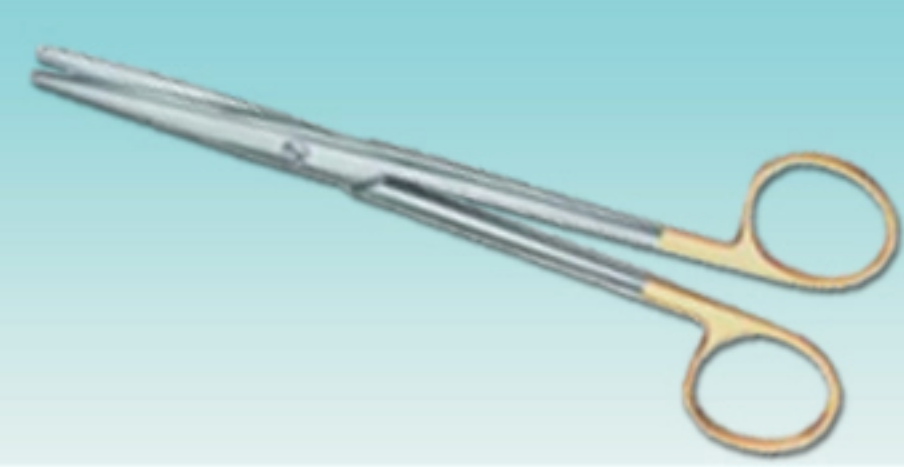

## Scissors (Dissecting Scissors)



METZENBAUM

14.5 cm/5¾"	Straight	Curved
Sharp/Blunt	<b>GS252.14</b>	<b>GS257.14</b>
Blunt/Blunt	<b>GS250.14</b>	<b>GS255.14</b>
Sharp/Sharp	<b>GS254.14</b>	<b>GS259.14</b>
16 cm/6¼"	Straight	Curved
Blunt/Blunt	<b>GS280.16</b>	<b>GS285.16</b>



METZENBAUM

14.5 cm/5¾"	Straight	Curved
	<b>GS938.14</b>	<b>GS939.14</b>



METZENBAUM

14.5 cm/5¾"	Straight	Curved
	<b>GS658.14</b>	<b>GS659.14</b>



METZENBAUM

11.5 cm/4½"	Straight	Curved
	<b>GS248.11</b>	<b>GS249.11</b>



METZENBAUM

11.5 cm/4½"	Straight	Curved
	<b>GS936.11</b>	<b>GS937.11</b>



METZENBAUM

11.5 cm/4½"	Straight	Curved
	<b>GS658.11</b>	<b>GS659.11</b>



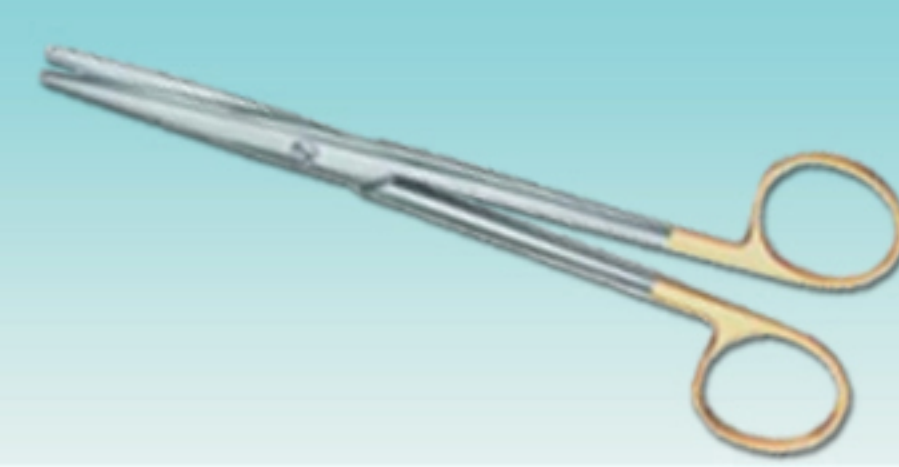

## Scissors (Dissecting Scissors & Vascular Scissors)



METZENBAUM

	Straight	Curved
18.0 cm/7"	<b>GS280.18</b>	<b>GS285.18</b>
20.5 cm/8"	<b>GS280.20</b>	<b>GS285.20</b>
23 cm/9"	<b>GS280.23</b>	<b>GS285.23</b>
26.0 cm/10¼"	<b>GS280.26</b>	<b>GS285.26</b>
28.5 cm/11¼"	<b>GS280.28</b>	<b>GS285.28</b>
31.0 cm/30½"	<b>GS280.31</b>	<b>GS285.31</b>



METZENBAUM

	Straight	Curved
18.0 cm/7"	<b>GS942.18</b>	<b>GS943.18</b>
20.5 cm/8"	<b>GS942.20</b>	<b>GS943.20</b>
23 cm/9"	<b>GS942.23</b>	<b>GS943.23</b>
26.0 cm/10¼"	<b>GS942.26</b>	<b>GS943.26</b>
28.5 cm/11¼"	<b>GS942.28</b>	<b>GS943.28</b>
31.0 cm/30½"	<b>GS942.31</b>	<b>GS943.31</b>

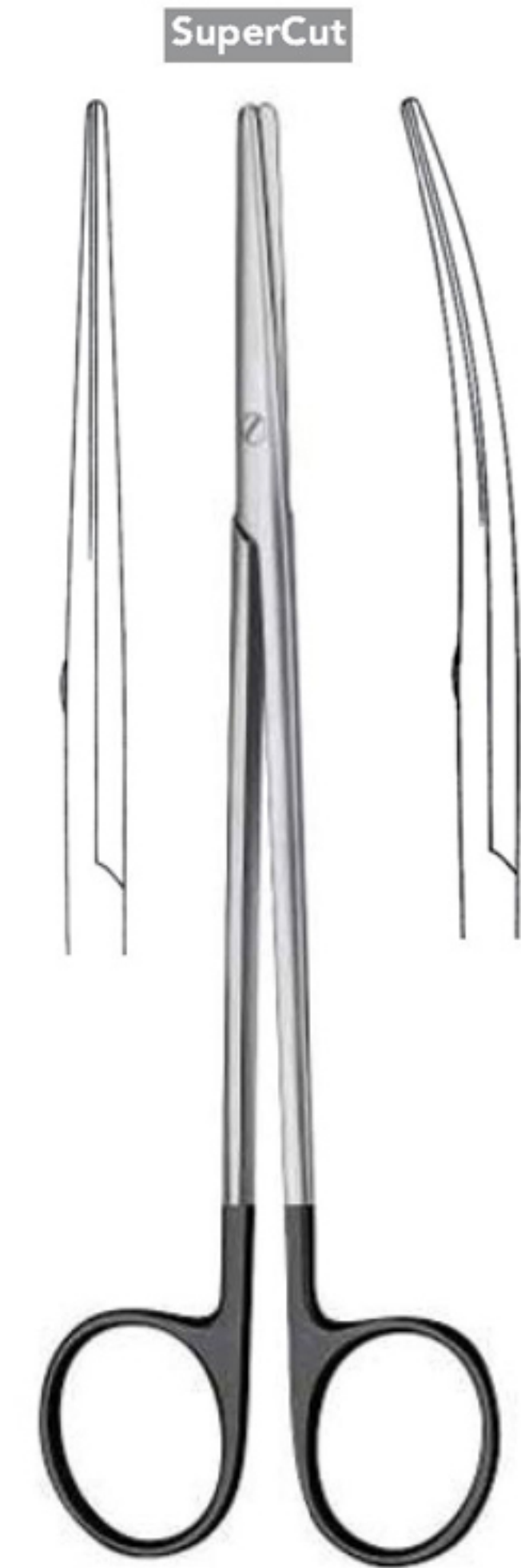

METZENBAUM

	Straight	Curved
18.0 cm/7"	<b>GS660.18</b>	<b>GS661.18</b>
20.5 cm/8"	<b>GS660.20</b>	<b>GS661.20</b>
23 cm/9"	<b>GS660.23</b>	<b>GS661.23</b>
26.0 cm/10¼"	<b>GS660.26</b>	<b>GS661.26</b>
28.5 cm/11¼"	<b>GS660.28</b>	<b>GS661.28</b>
31.0 cm/30½"	<b>GS660.31</b>	<b>GS661.31</b>

Ligature scissors

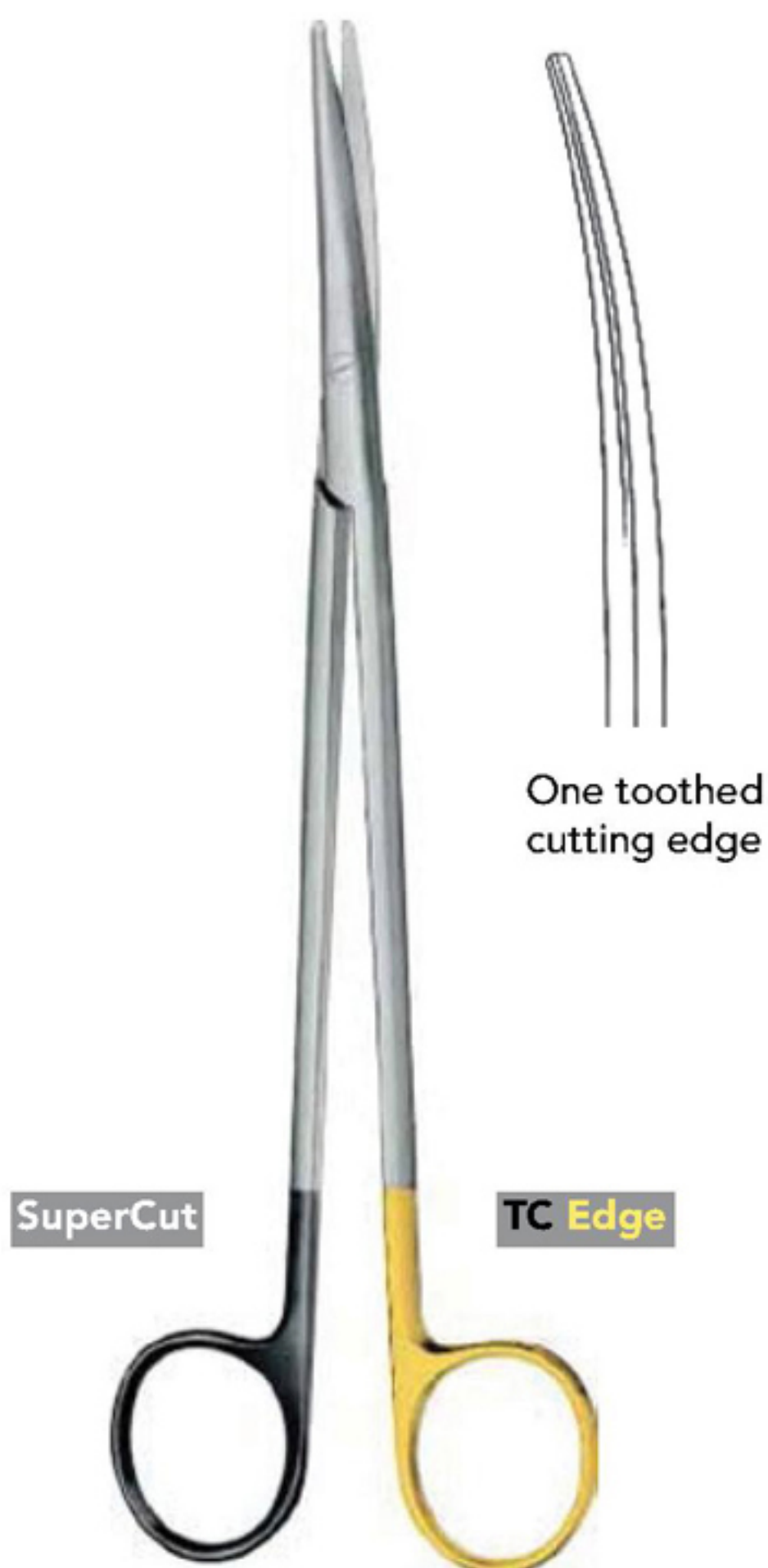

One toothed cutting edge

METZENBAUM

11.5 cm/4½"	<b>GS914.11</b>
14.5 cm/5¾"	<b>GS914.14</b>
18.0 cm/7"	<b>GS914.18</b>
20.5 cm/8"	<b>GS914.20</b>
23 cm/9"	<b>GS914.23</b>
25.0 cm/9¾"	<b>GS914.25</b>
30.0 cm/11¾"	<b>GS914.30</b>

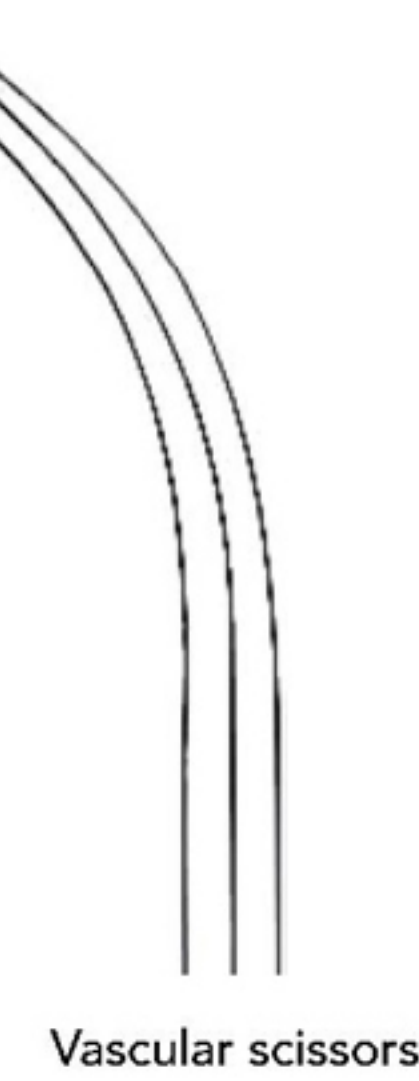

Vascular scissors

METZENBAUM-THOREK

20 cm/8"	<b>GS945.20</b>
23 cm/9"	<b>GS945.23</b>
28 cm/11"	<b>GS945.28</b>



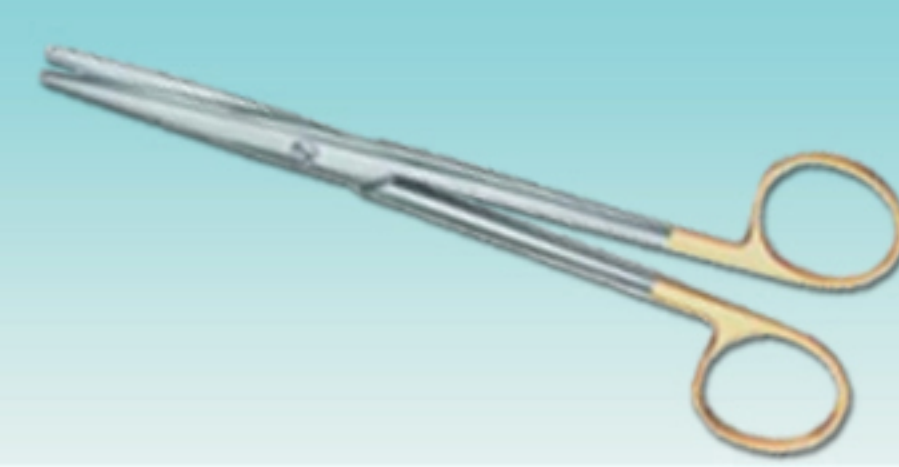

## Scissors (Dissecting Scissors)

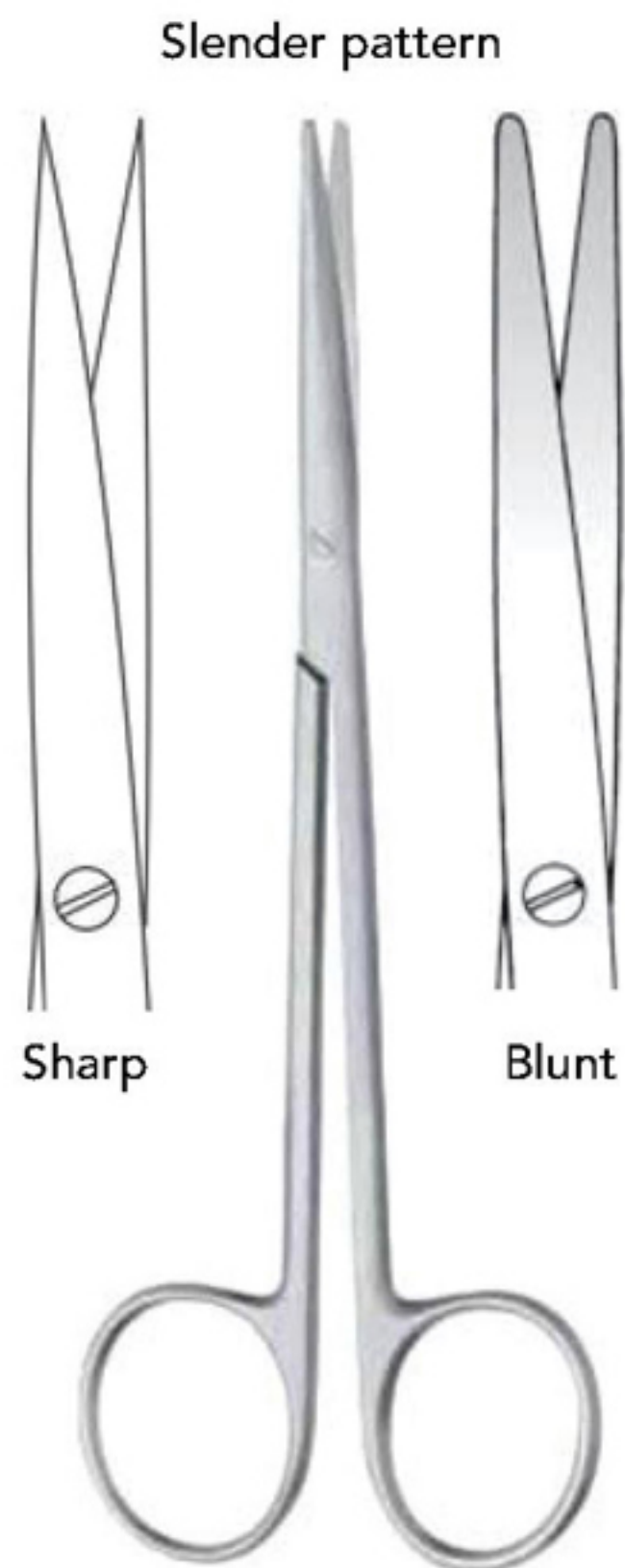

**BABY METZENBAUM**  
14.5 cm/5¾"

	Straight	Curved
Blunt/Blunt	<b>GS326.14</b>	<b>GS327.14</b>
Sharp/Sharp	<b>GS328.14</b>	<b>GS329.14</b>

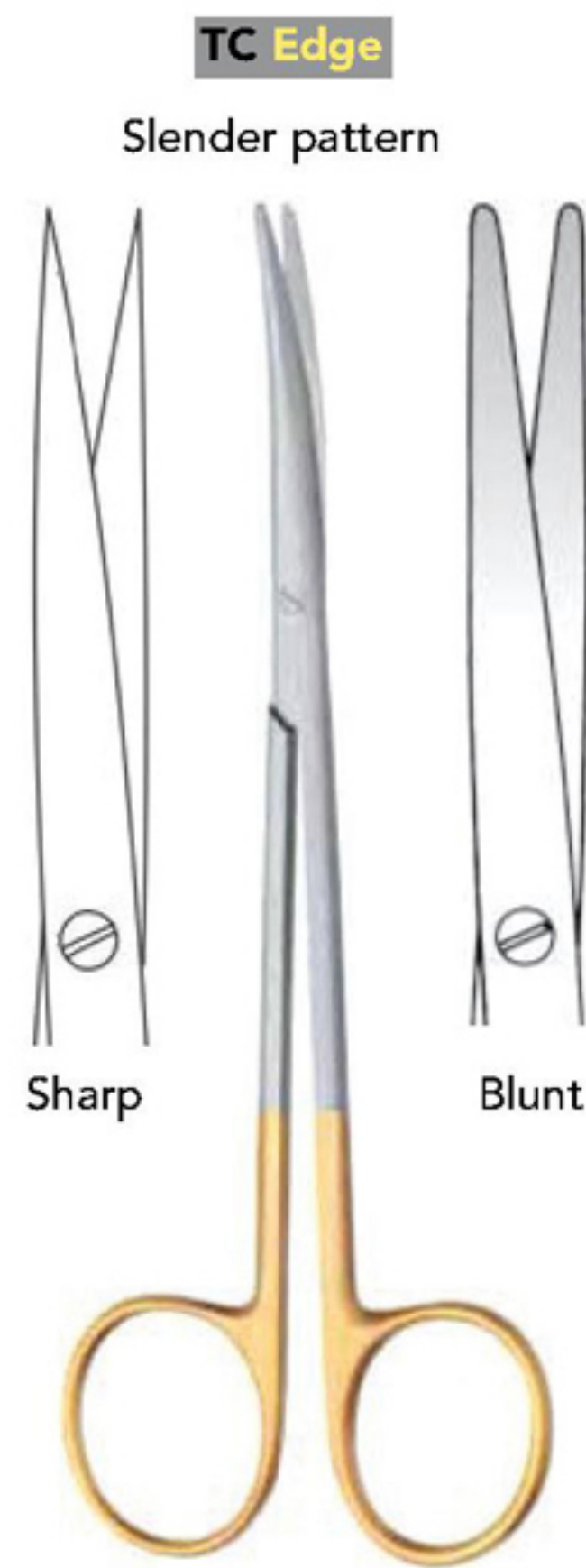

**BABY METZENBAUM**  
14.5 cm/5¾"

	Straight	Curved
Blunt/Blunt	<b>GS954.14</b>	<b>GS955.14</b>
Sharp/Sharp	<b>GS956.14</b>	<b>GS957.14</b>



**METZENBAUM-FINO**

14.5 cm/5¾"	<b>GS665.14</b>
-------------	-----------------

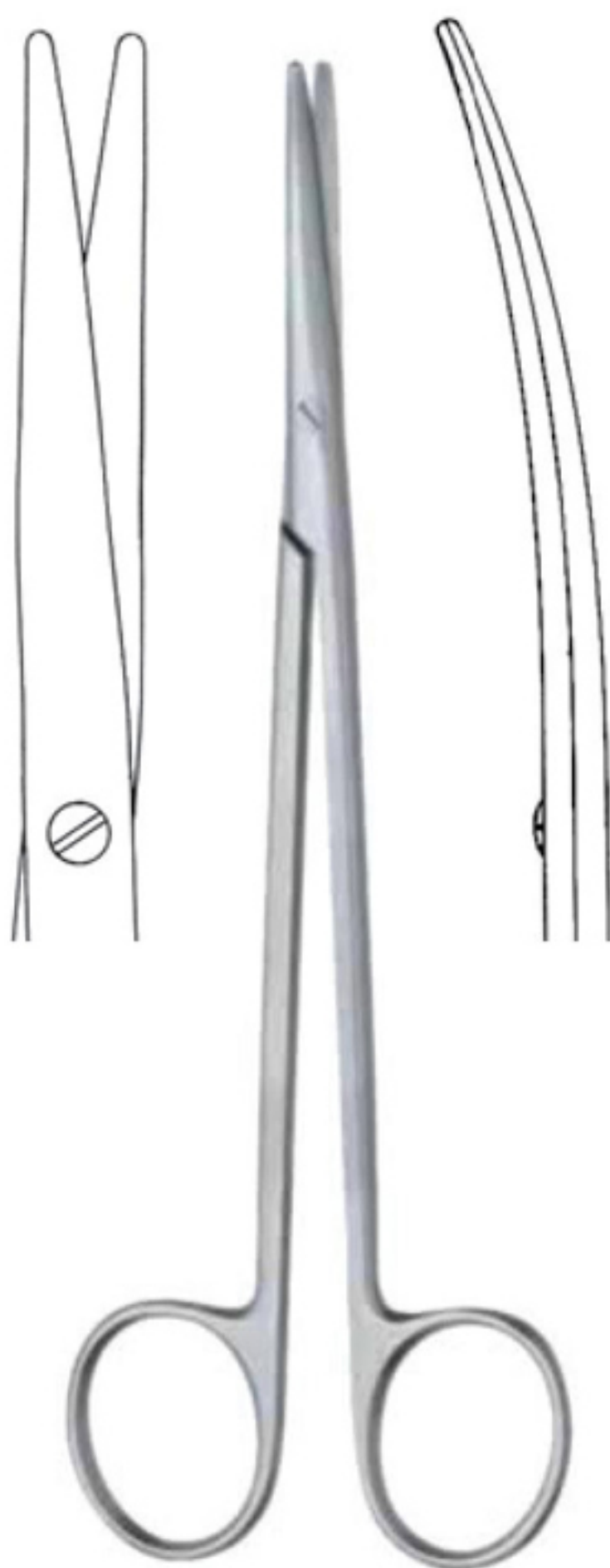

**NELSON-METZENBAUM**

	Straight	Curved
18.0 cm/7"	<b>GS330.18</b>	<b>GS331.18</b>
20.5 cm/8¼"	<b>GS330.20</b>	<b>GS331.20</b>
23.0 cm/9"	<b>GS330.23</b>	<b>GS331.23</b>
26.0 cm/10¼"	<b>GS330.26</b>	<b>GS331.26</b>
28.5 cm/11¼"	<b>GS330.28</b>	<b>GS331.28</b>

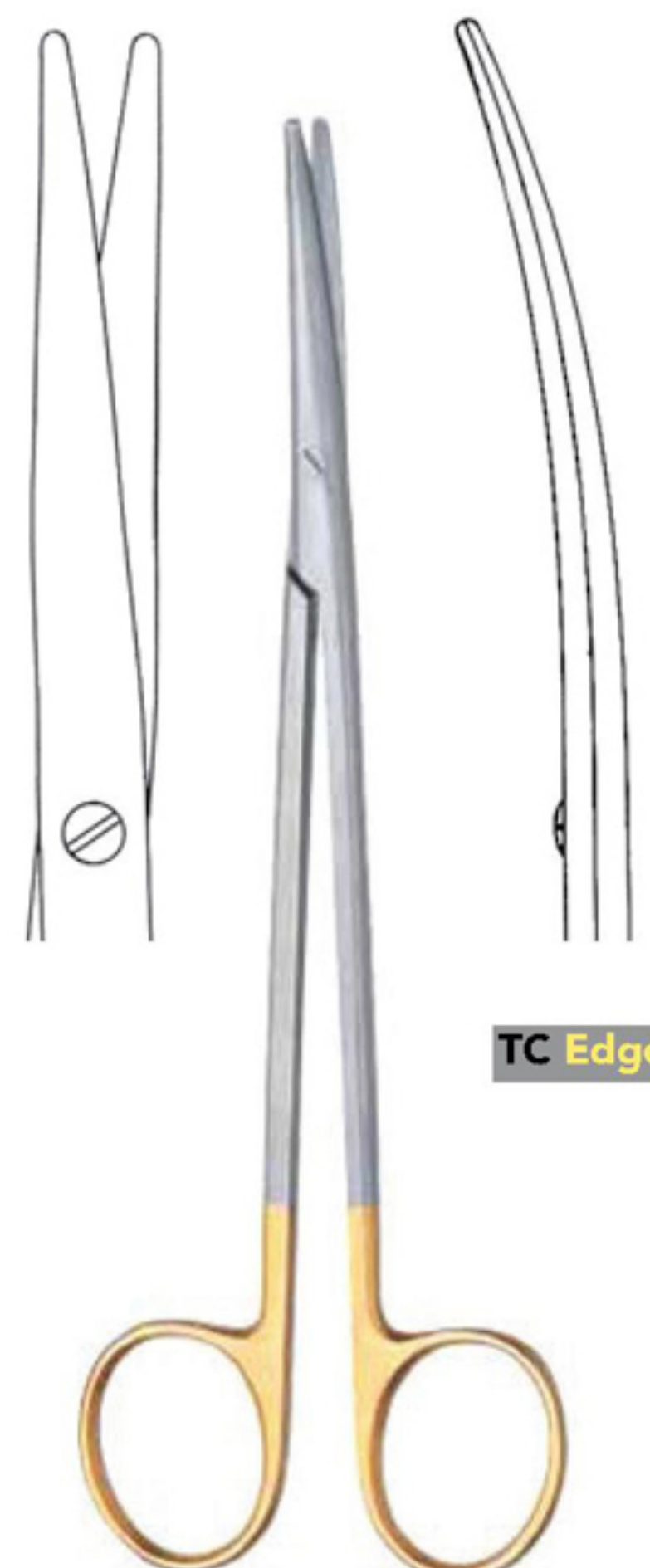

**NELSON-METZENBAUM**

	Straight	Curved
18.0 cm/7"	<b>GS960.18</b>	<b>GS961.18</b>
20.5 cm/8¼"	<b>GS960.20</b>	<b>GS961.20</b>
23.0 cm/9"	<b>GS960.23</b>	<b>GS961.23</b>
26.0 cm/10¼"	<b>GS960.26</b>	<b>GS961.26</b>
28.5 cm/11¼"	<b>GS960.28</b>	<b>GS961.28</b>

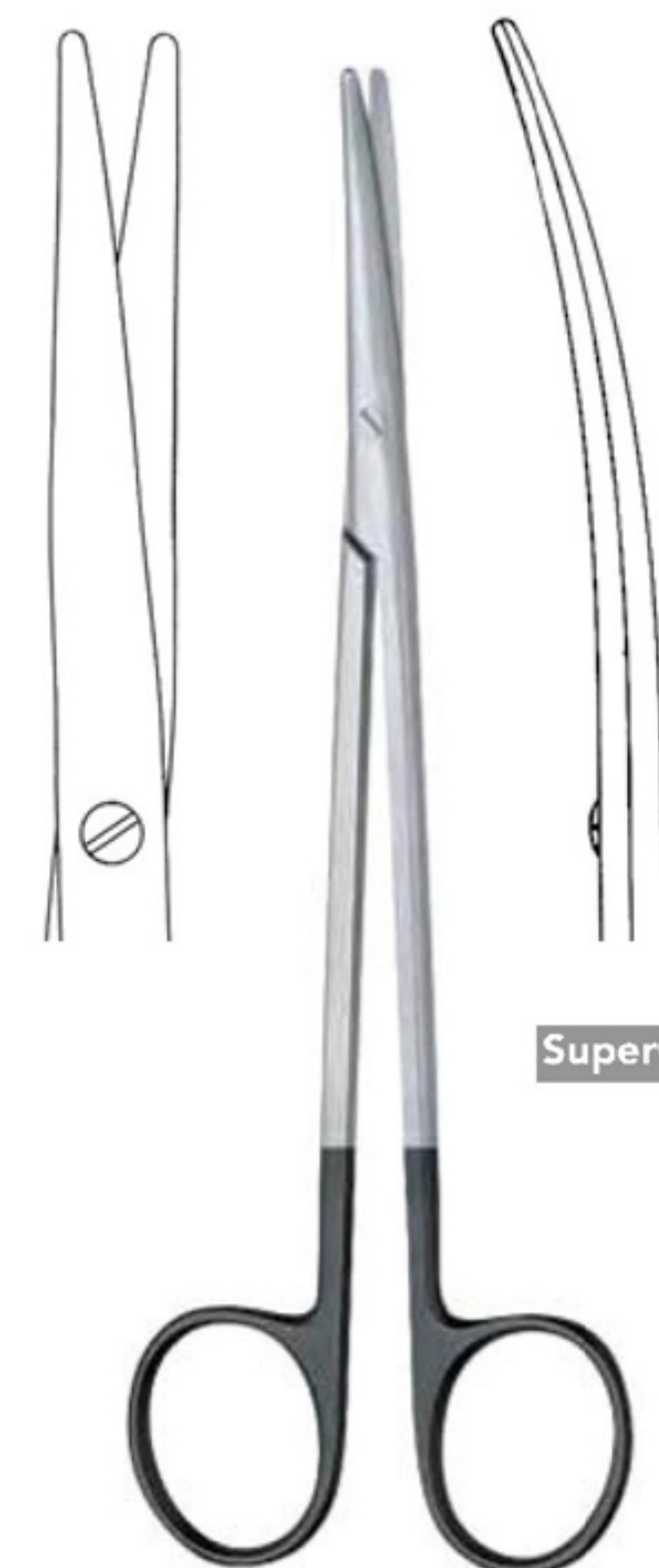

**NELSON-METZENBAUM**

	Straight	Curved
18.0 cm/7"	<b>GS664.18</b>	<b>GS665.18</b>
20.5 cm/8¼"	<b>GS664.20</b>	<b>GS665.20</b>
23.0 cm/9"	<b>GS664.23</b>	<b>GS665.23</b>
26.0 cm/10¼"	<b>GS664.26</b>	<b>GS665.26</b>
28.5 cm/11¼"	<b>GS664.28</b>	<b>GS665.28</b>



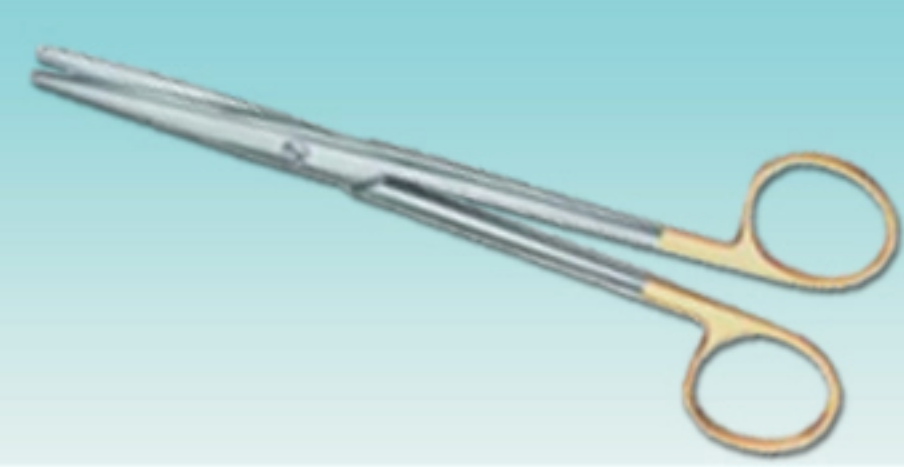

## Scissors (Dissecting Scissors)

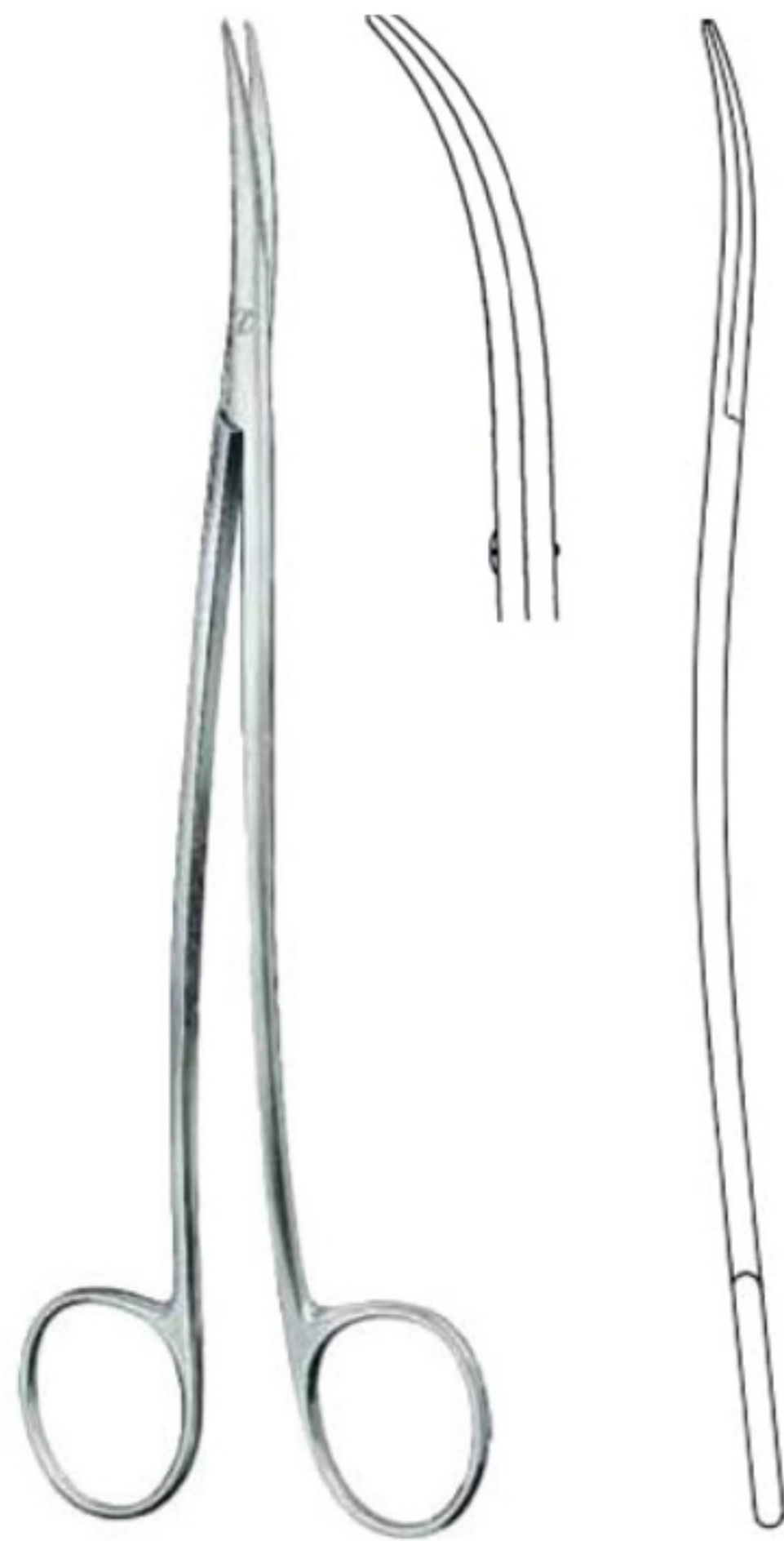

**METZENBAUM-FINO**  
 18.0 cm/7" **GS335.18**  
 20.5 cm/8" **GS335.20**  
 23 cm/9" **GS335.23**

Slender pattern  
S-shaped



**METZENBAUM-FINO**  
 18.0 cm/7" **GS967.18**  
 20.5 cm/8" **GS967.20**  
 23 cm/9" **GS967.23**

TC Edge

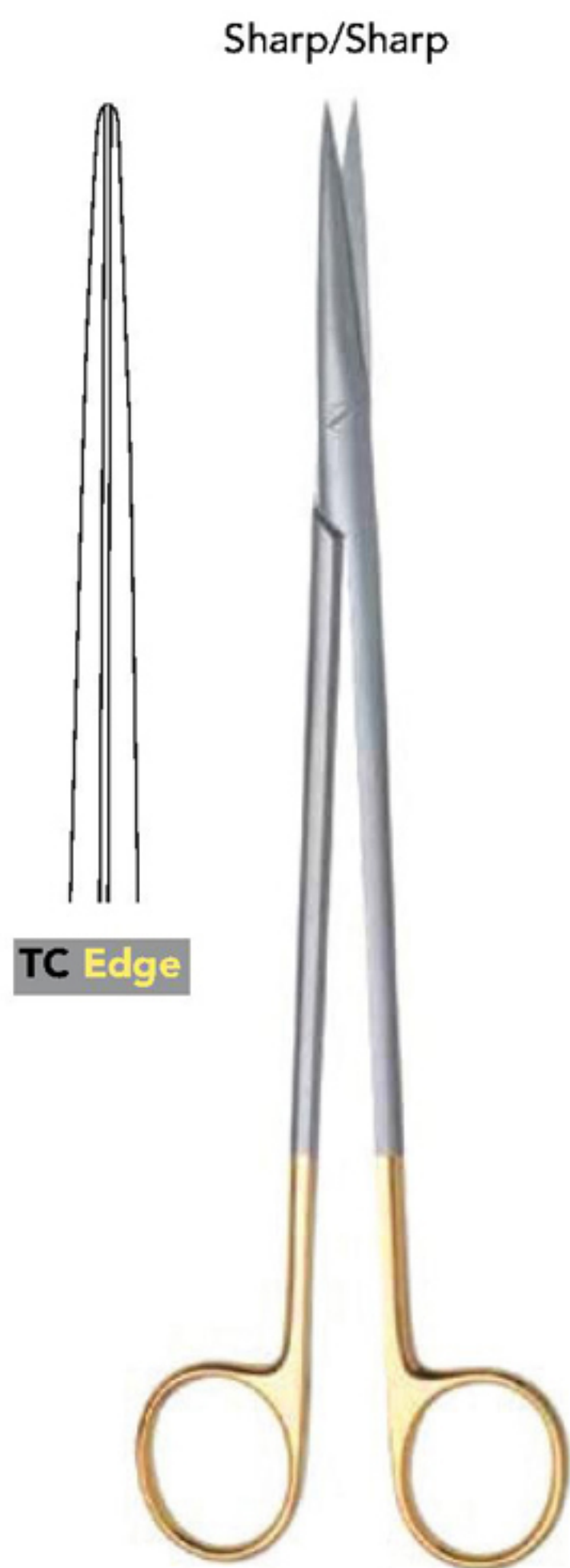

**METZENBAUM-FINO**  
 18.0 cm/7" **GT962.18**  
 20.0 cm/8" **GT962.20**  
 23.0 cm/9" **GT962.23**

Sharp/Sharp

TC Edge



**METZENBAUM-FINO**  
 20.0 cm/8" **GT965.20**  
 23.0 cm/9" **GT965.23**

Blunt/Blunt

TC Edge

Delicate slender pattern

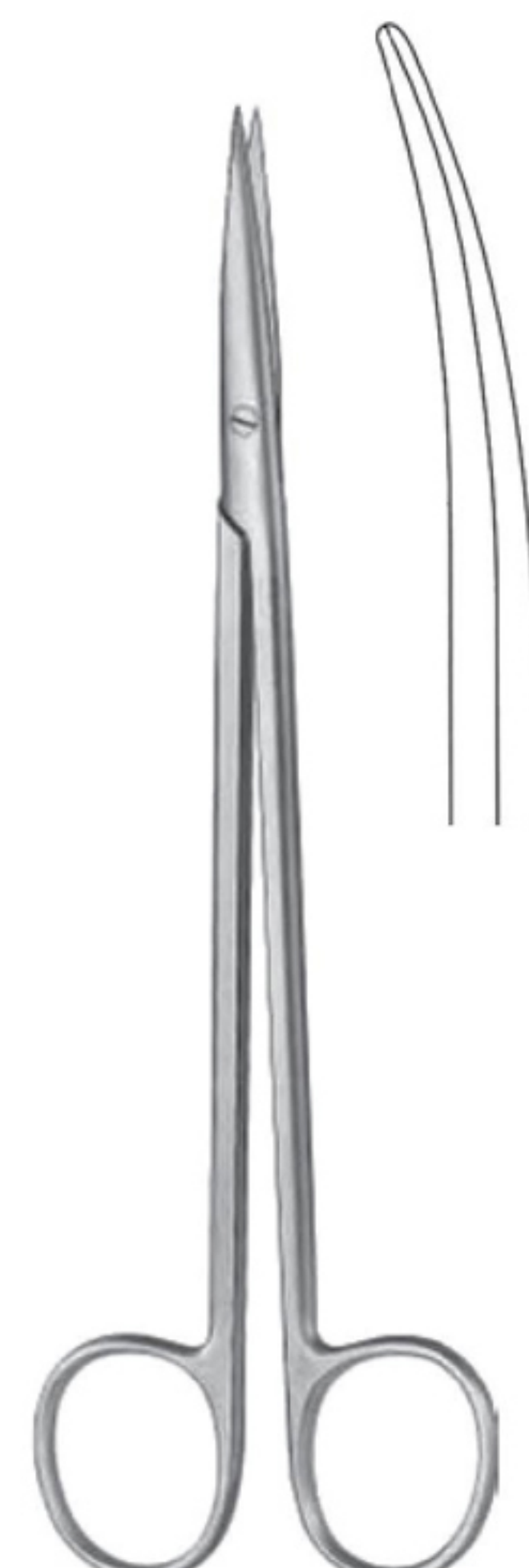

**METZENBAUM-NELSON**  
 18 cm/7" **GS284.18**  
 20.5 cm/8" **GS284.20**



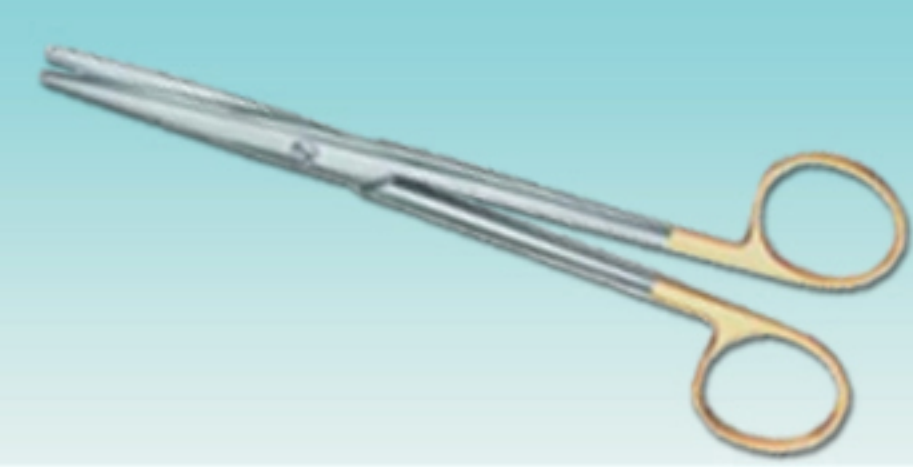

## Scissors (Dissecting Scissors)

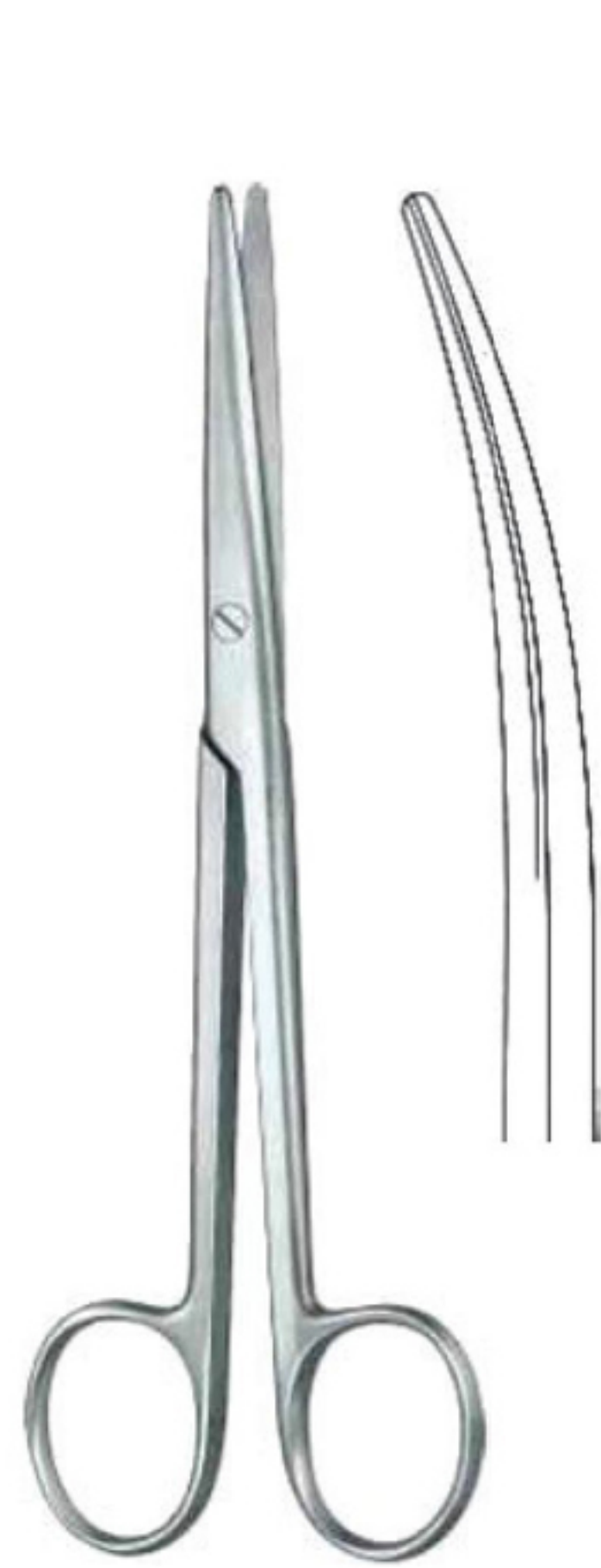

LEXER  
16 cm/6 1/4"

Straight Curved  
GS310.16 GS311.16



LEXER

Straight Curved  
16 cm/6 1/4" **GS950.16** **GS951.16**  
21 cm/8 1/4" **GS950.21** **GS951.21**



LEXER  
16 cm/6 1/4"

Straight Curved  
**GS662.16** **GS663.16**

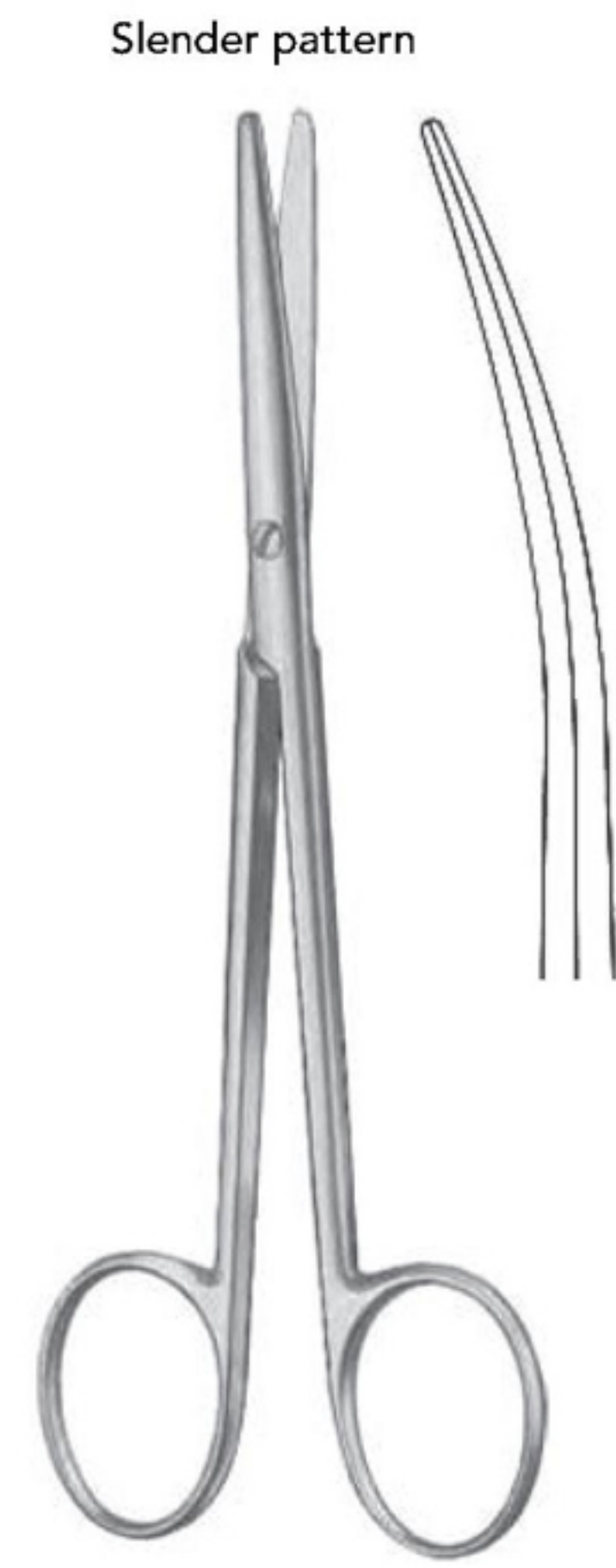

LEXER-FINO  
16 cm/6 1/4"

Straight Curved  
GS324.16 GS325.16



LEXER-BABY  
10 cm/4"

Straight Curved  
GS320.10 GS321.10

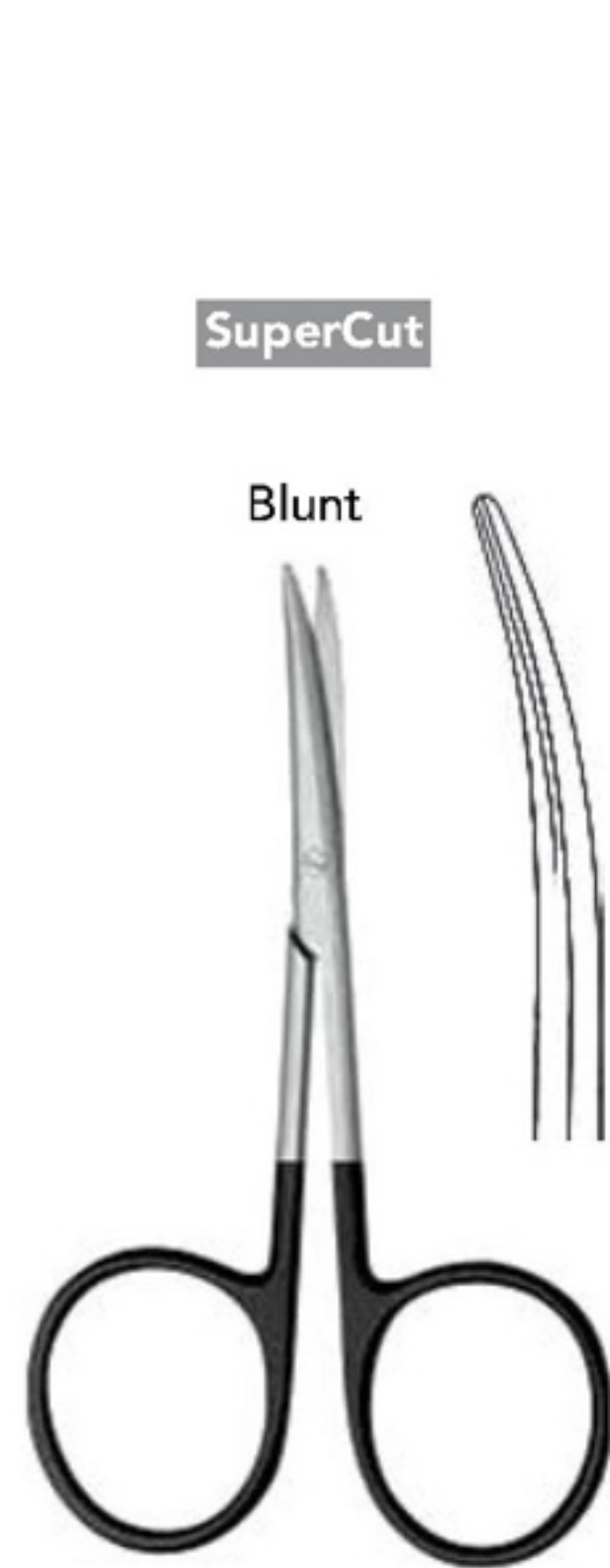

LEXER-BABY  
10 cm/4"

Straight Curved  
**GS662.10** **GS663.10**

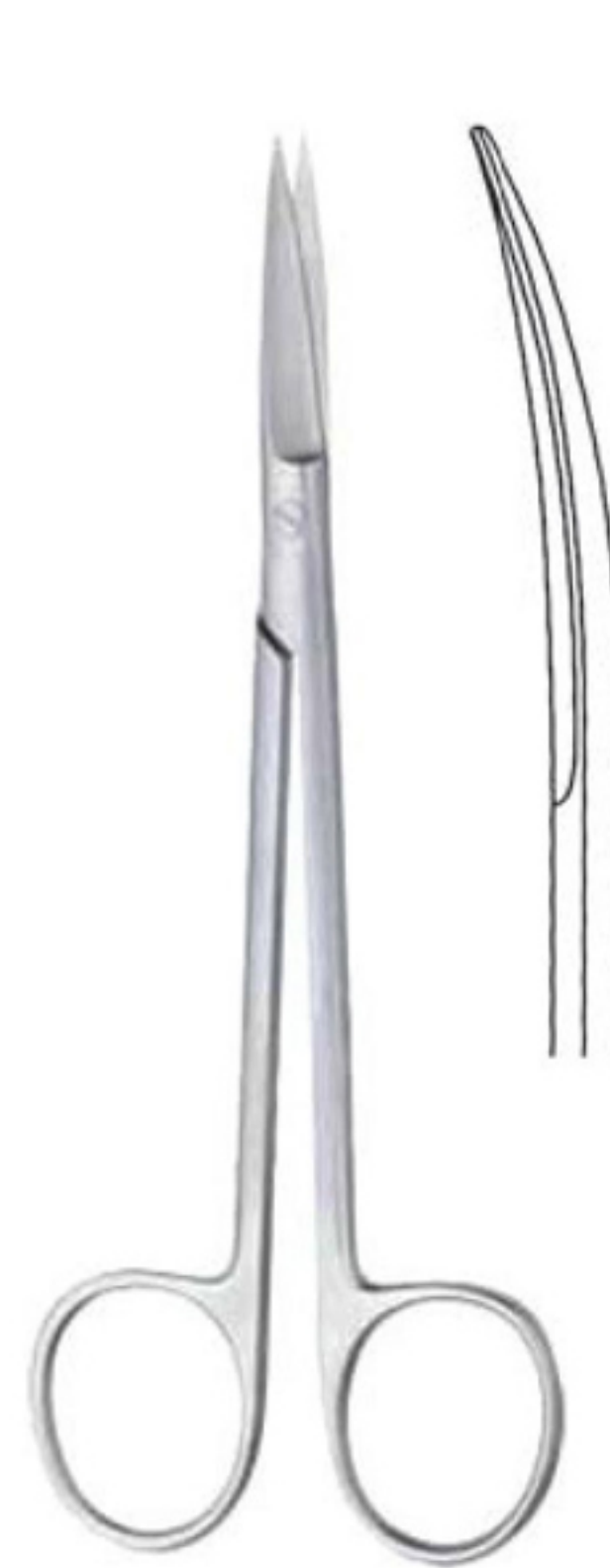

JOSEPH  
14.5 cm/5 3/4"

Straight Curved  
GS350.14 GS351.14



JOSEPH  
14.5 cm/5 3/4"

Straight Curved  
**GS948.14** **GS949.14**



JOSEPH  
14.5 cm/5 3/4"

Straight Curved  
**GS666.14** **GS667.14**



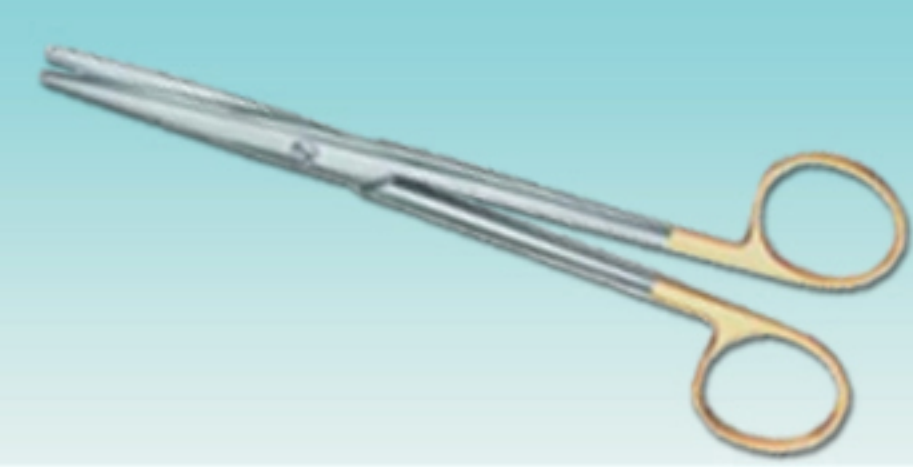

## Scissors (Delicate Dissecting Scissors)



KILNER

12 cm/4¾" **GS359.12**  
15 cm/6" **GS359.15**



SuperCut

KILNER

12 cm/4¾" **GS669.12**  
15 cm/6" **GS669.15**



REYNOLDS

**GS364.15**  
15.5 cm/6¼"



REYNOLDS

15.5 cm/6¼" **GS365.15**  
18.0 cm/7¼" **GS365.18**



SuperCut

REYNOLDS

15.5 cm/6¼" **GS671.15**  
18.0 cm/7¼" **GS671.18**



TOENNIS-ADSON  
**GS459.17**  
17.5 cm/7"



TC Edge

TOENNIS-ADSON  
**GS965.17**  
17.5 cm/7"



TOENNIS  
18 cm/7"

Straight **GS461.18**    Curved **GS462.18**



14.5 cm/5¾"

Straight **GS362.14**    Curved **GS363.14**



Dissecting scissors

**GS358.13**  
13 cm/5"



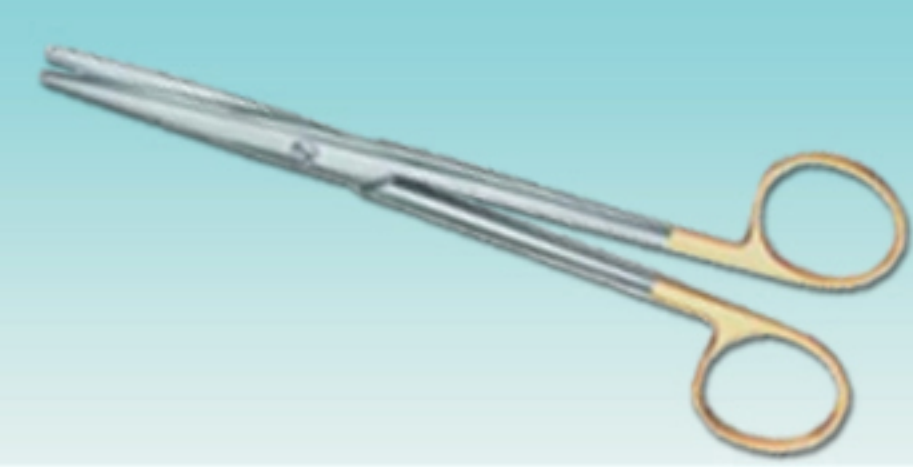

## Scissors (Dissecting & Vascular Scissors)

Delicate pattern one cutting edge with knife cut



**GS339.12**  
12.5 cm/5"

**GS339.18**  
18.0 cm/7"

SALYER



11 cm/4 1/4"

Straight **GS344.11** Curved **GS345.11**

Vein graft scissors



SHEA  
**GS357.12**  
12 cm/4 3/4"



SANVENERO  
14 cm/5 1/2"  
Straight **GS340.14** Curved **GS341.14**

Nerve dissecting scissors

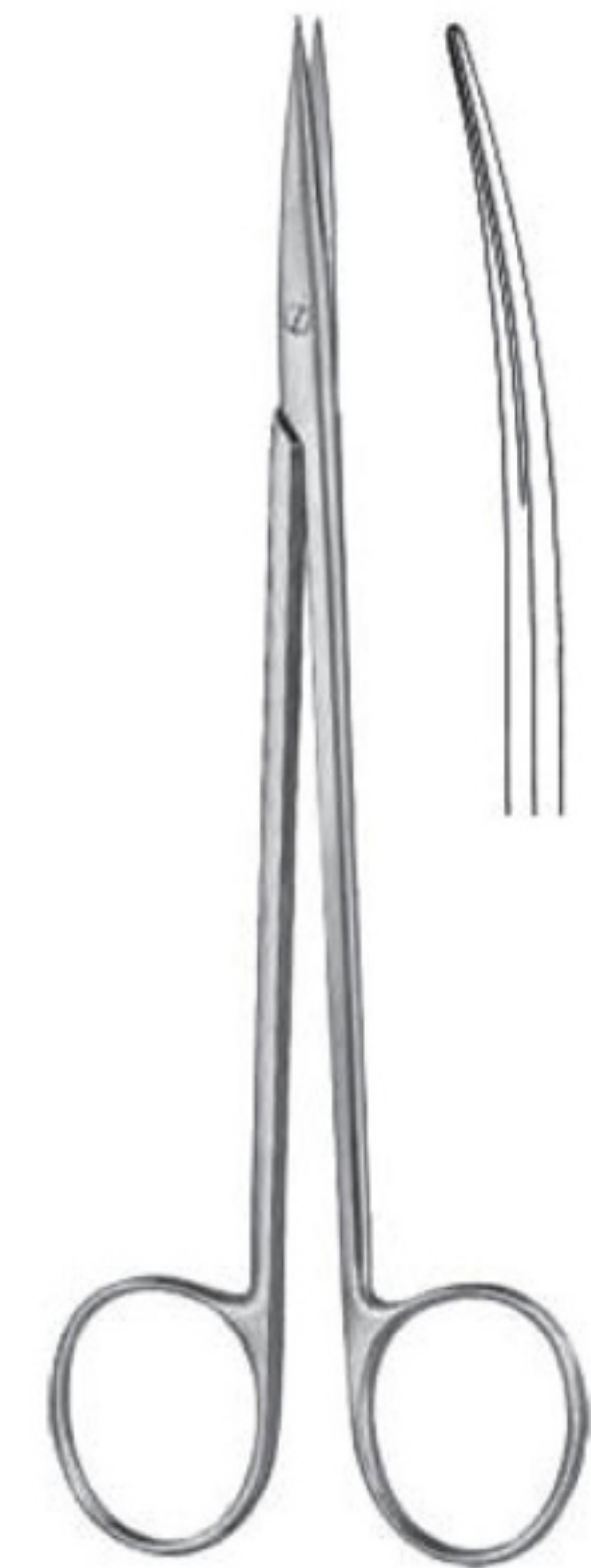

15.5 cm/6 1/4"

Straight **GS300.15** Curved **GS301.15**

Dissecting scissors



CINELLI  
**GS317.11**  
11.5 cm/4 1/2"



WERTHEIM  
**GS245.20**  
12 cm/4 3/4"



**GS420.11**  
12 cm/4 3/4"



**GS421.14**  
14 cm/5 1/2"

Vascular scissors



**GS422.15**  
14.5 cm/5 3/4"



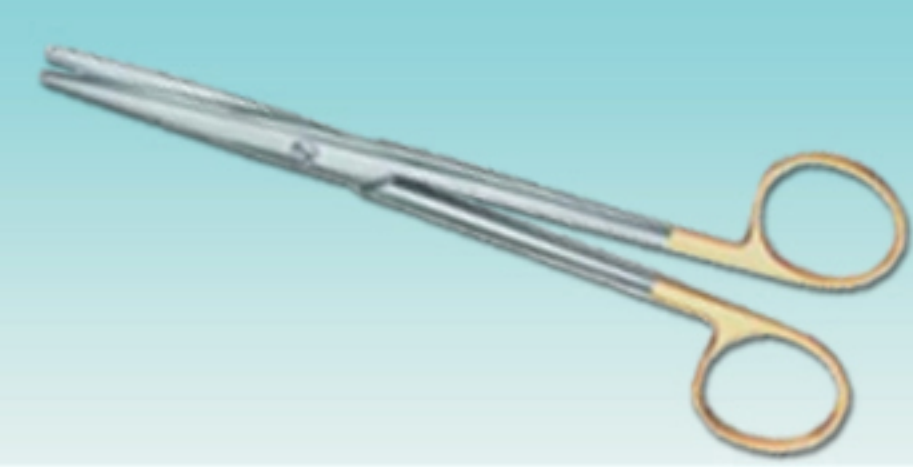

## Scissors (Vascular Scissors, Dissecting Scissors)

Dura scissors

One toothed cutting edge



**FAVALORO**  
**GS419.90**  
14.5 cm/5¾"



**FAVALORO**  
**GS435.01**  
18 cm/7"



**SCHMIEDEN-TAYLOR**  
**GS455.17**  
16.5 cm/6½"

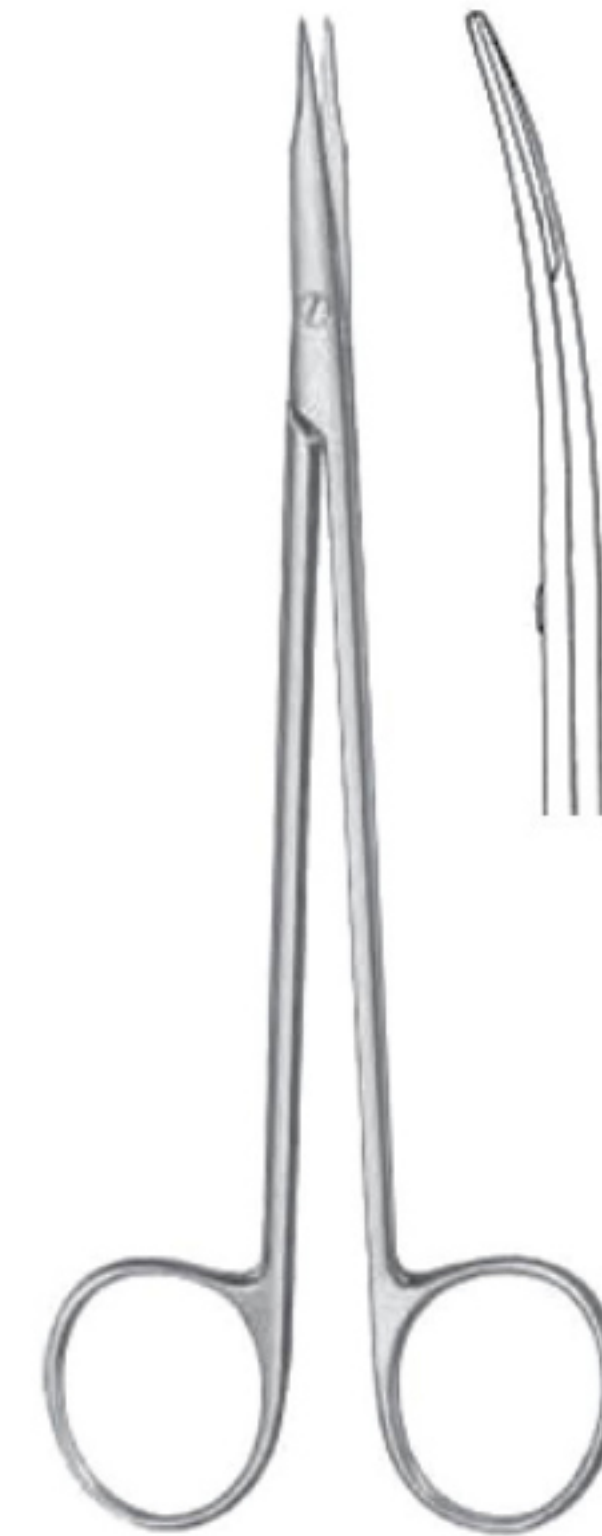

**JAMESON**  
**GS367.14**  
15.5 cm/6¼"



**JAMESON**  
**GS369.14**  
15.5 cm/6¼"



**THOREK**  
**GS319.19**  
18.5 cm/7¼"

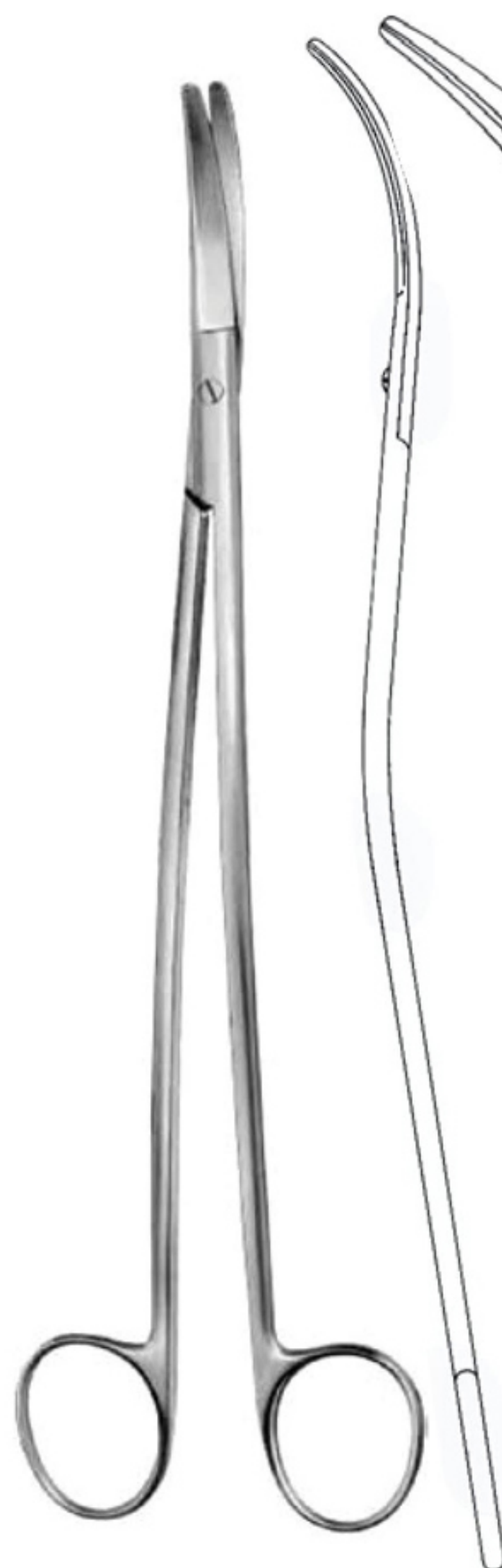

**SATINSKY**  
**GS375.24**  
25.5 cm/10"

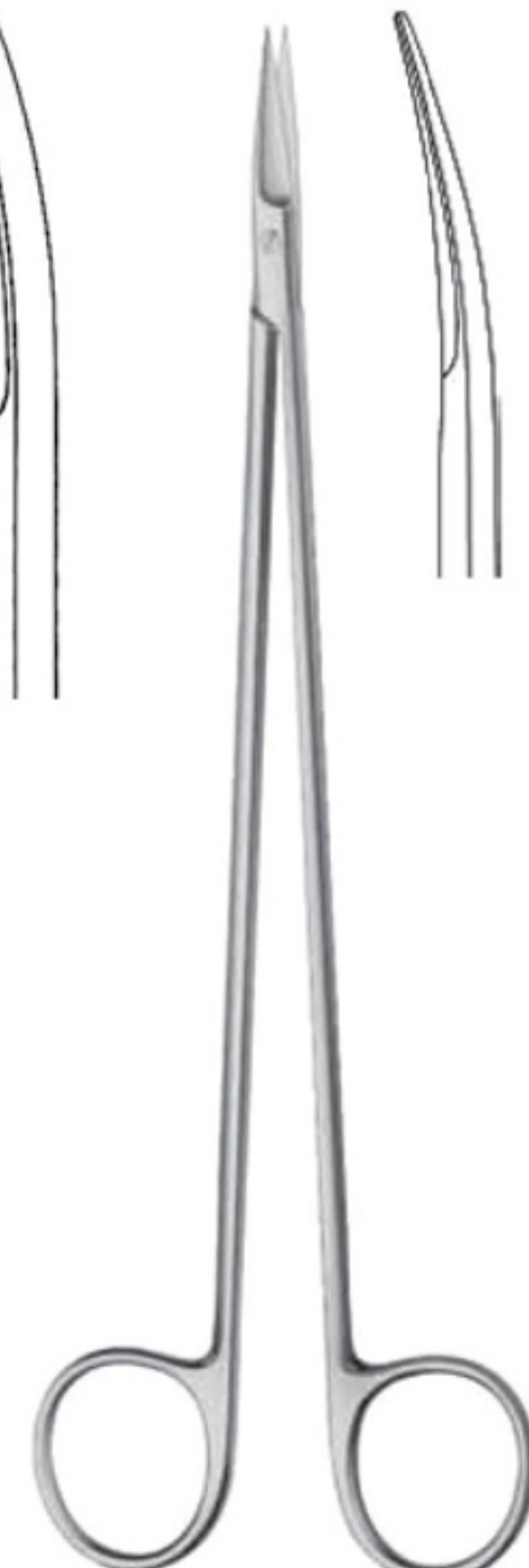

20 cm/8"  
Straight Curved  
**GS374.19** **GS375.19**



**POTTS-DE MARTELL**  
18 cm/7"

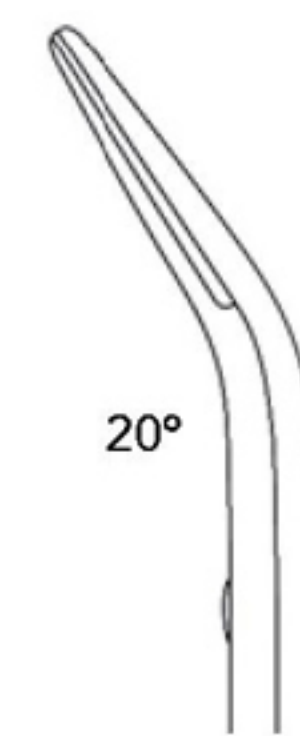

20°  
**GS886.20**

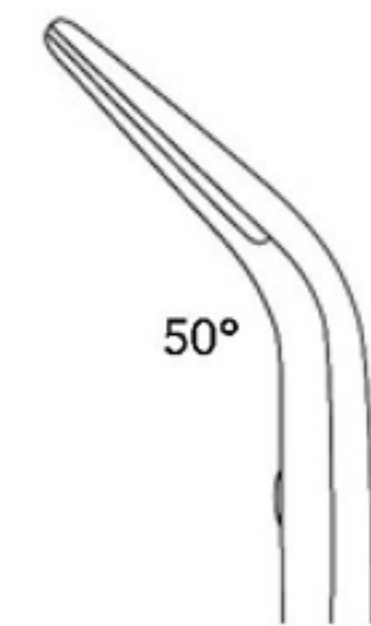

50°  
**GS886.50**

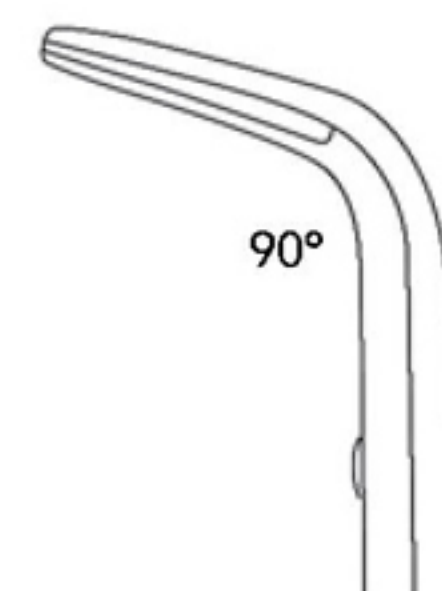

90°

**GS886.90**



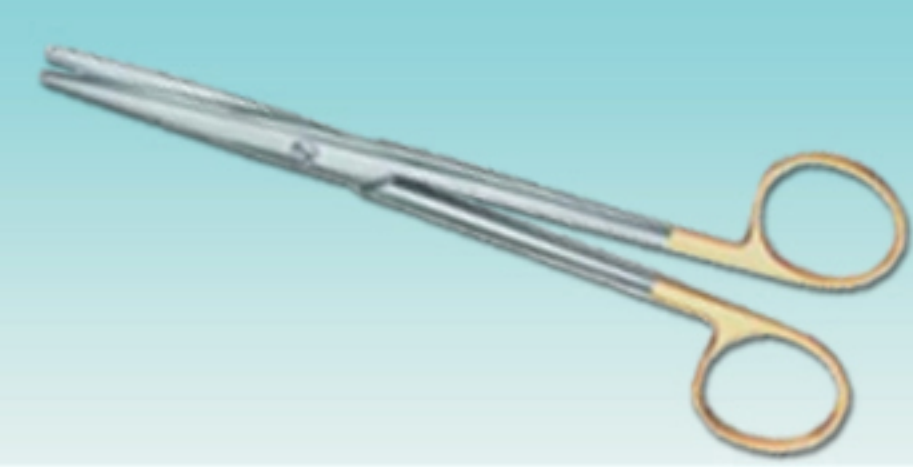

## Scissors (Dissecting & Vascular Scissors)



**DEBAKEY**  
 17.5 cm/7" **GS315.17** **GS316.18**  
 20 cm/8" **GS315.20** **GS316.20**



**HOHENFELLNER**  
 18 cm/7¼" **GS313.18** **GS.314.18**  
 21 cm/8¼" **GS313.21** **GS.314.21**  
 24 cm/9½" **GS313.24** **GS.314.24**



**LILLEHEI-POTTS**  
**GS882.18**  
 18 cm/7"

### Neurosurgical scissors



**GS445.22**

**GS446.22**

### One serrated cutting edge

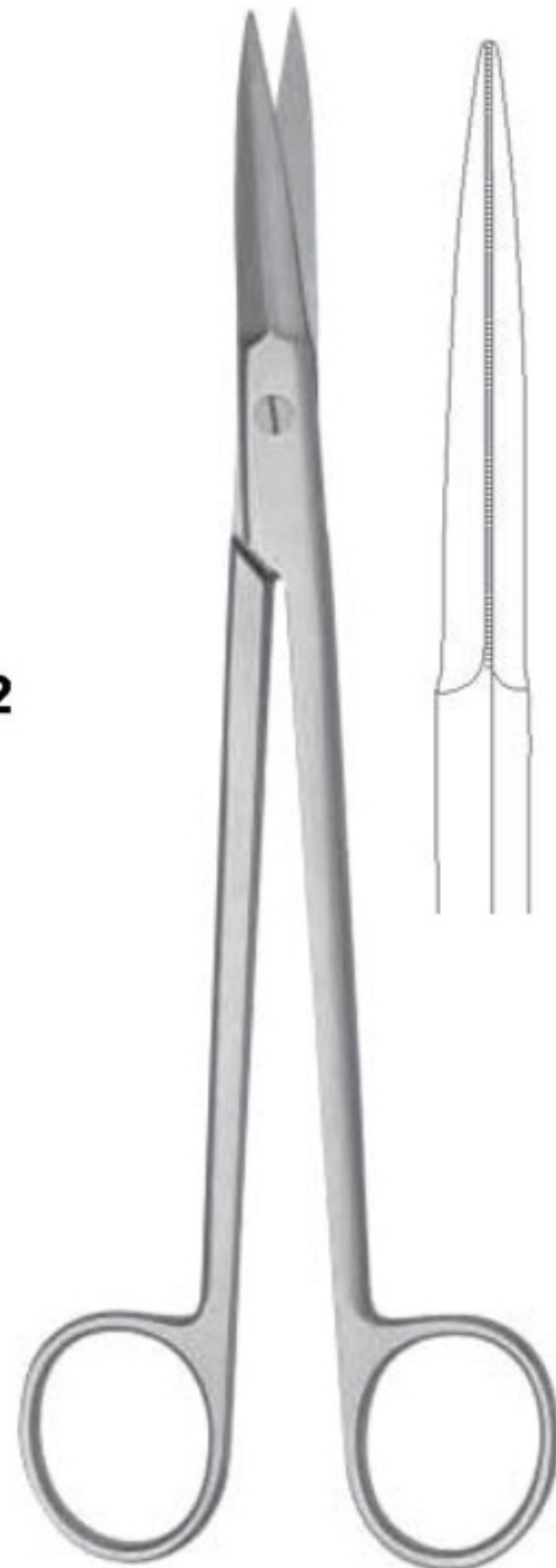

**MCINDOE**  
**GS480.19**  
 18.5 cm/7¾"

**STRULLY**  
 22 cm/8¾"

### Trigeminal scissors

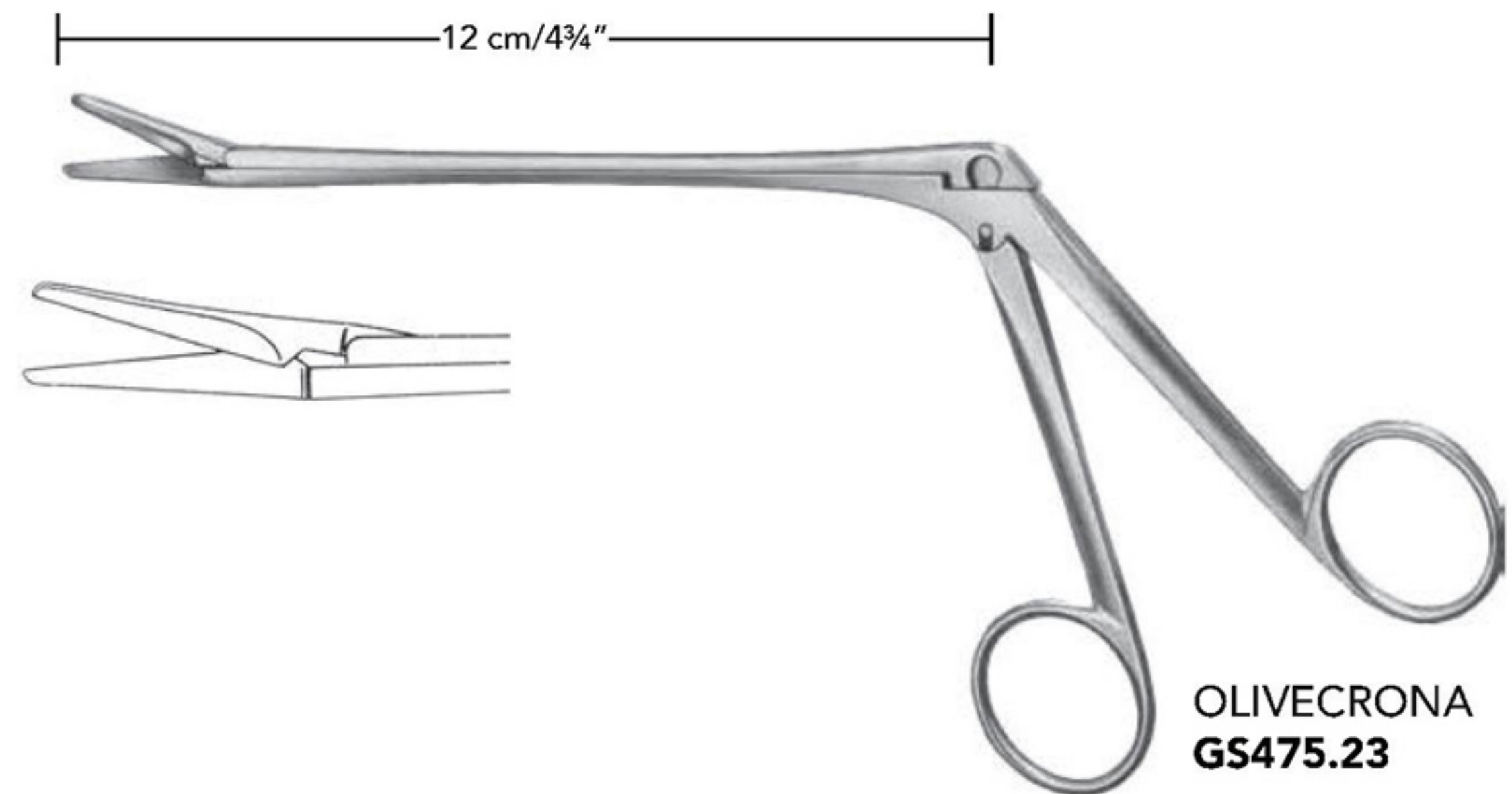

**OLIVECRONA**  
**GS475.23**



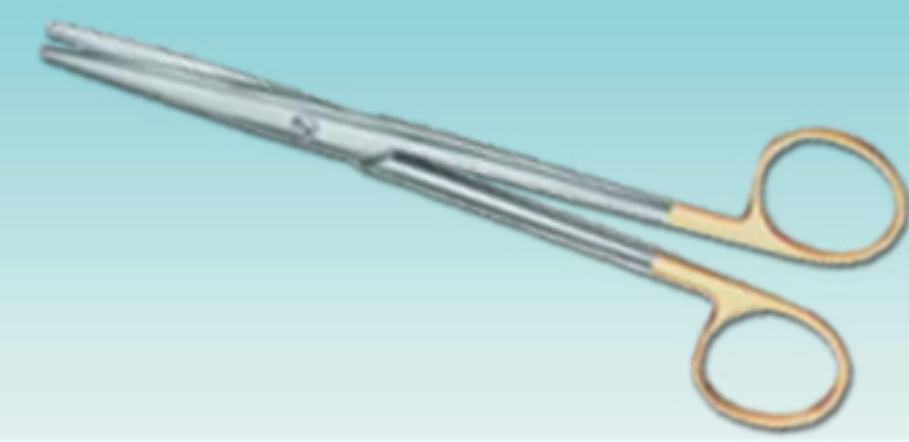

## Scissors (Cornoary & Vascular Scissors)

One cutting edge with knife cut for cleft palate



**DIETRICH-SALYER**  
**GS379.45**  
12 cm / 4¾"

10 mm



**DIETRICH-HEGEMANN**  
18 cm / 7"

25° **GS380.25**

45° **GS380.45**

60° **GS380.60**

90° **GS380.90**

125° **GS381.00**

10 mm

with guidance



**DIETRICH**  
**GS381.01**  
17.5 cm / 7"

10 mm



**DIETRICH-HEGEMANN**  
18.5 cm / 7½"

25° **GS427.25**

45° **GS427.45**

60° **GS427.60**

90° **GS427.90**

125° **GS428.00**

7 mm



**MICRO-HEGEMANN**  
18.5 cm / 7½"

25° **GS382.25**

45° **GS382.45**

60° **GS382.60**

**GS382.90**

V-Neck  
125° **GS383.01**



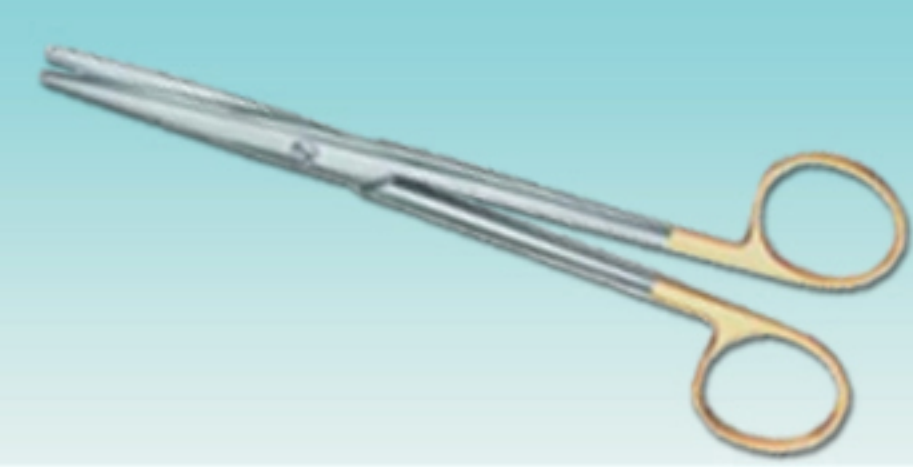

## Scissors (Cornoary & Vascular Scissors)



POTTS-SMITH  
18.5 cm/7½"

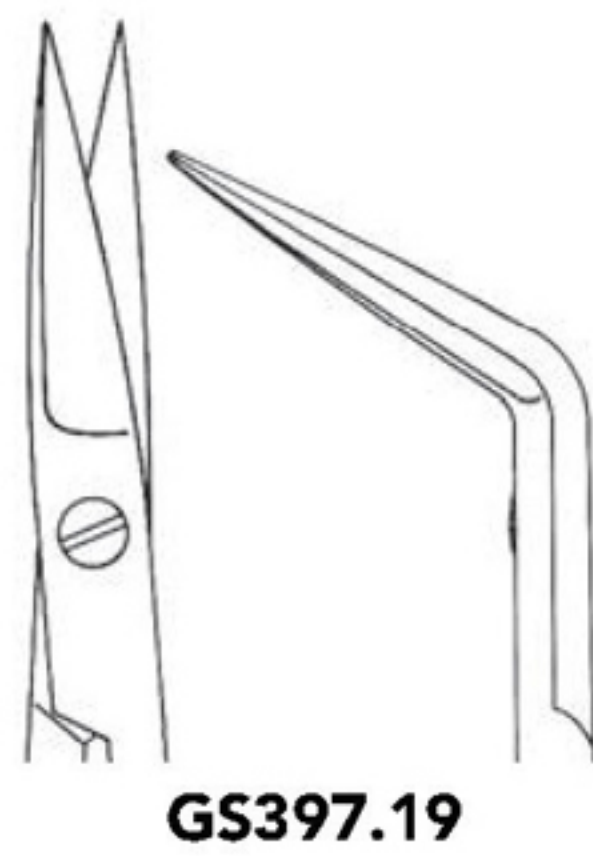
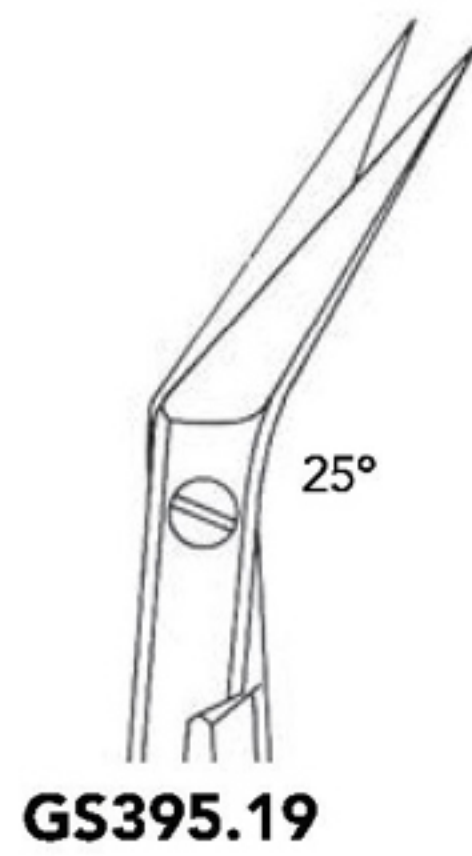
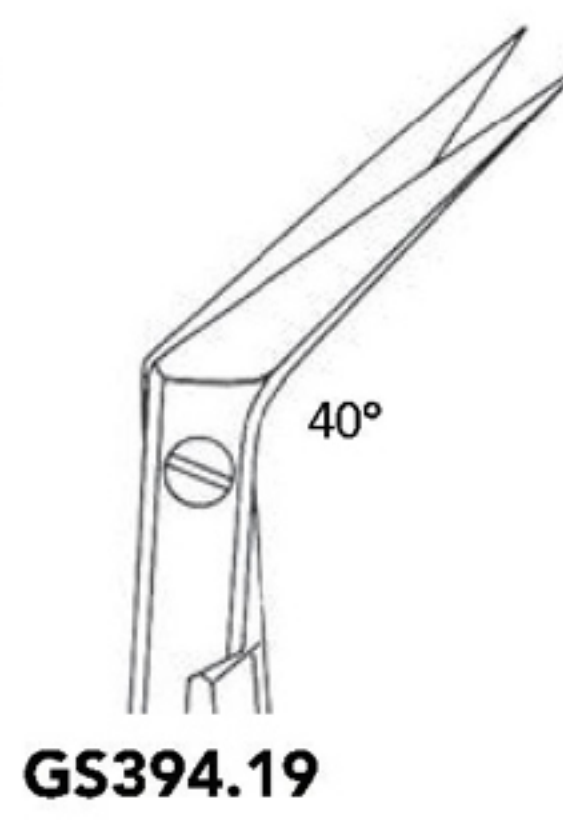
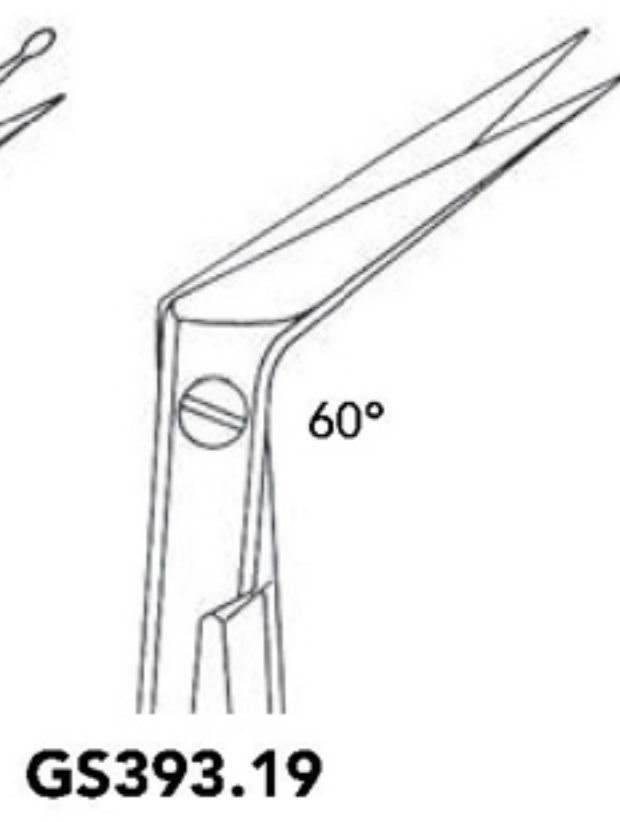
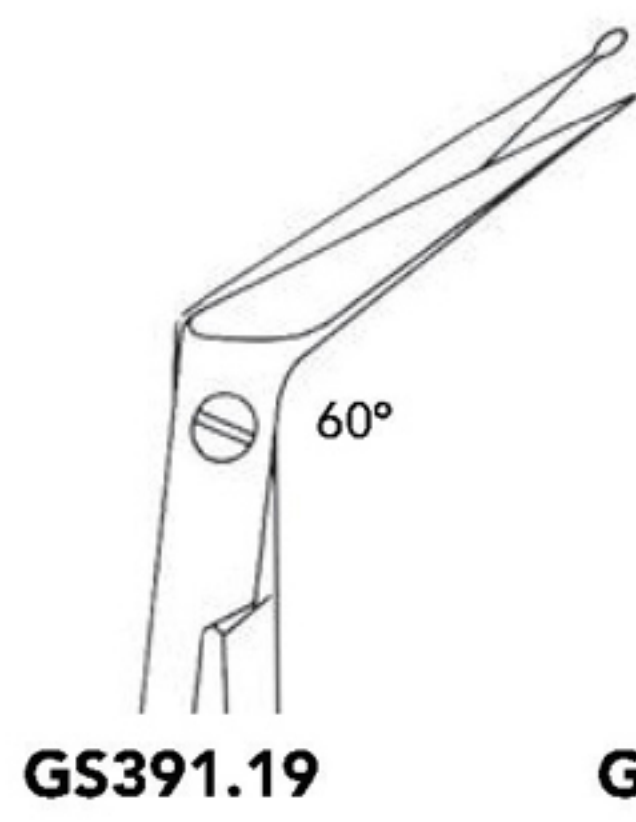

POTTS-SMITH  
18.5 cm/7½"

TC Edge

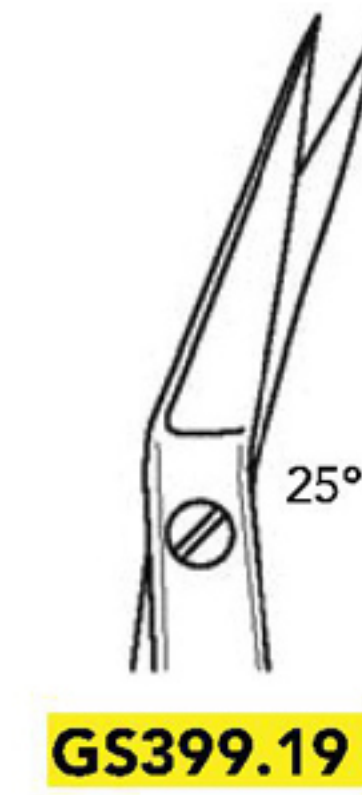
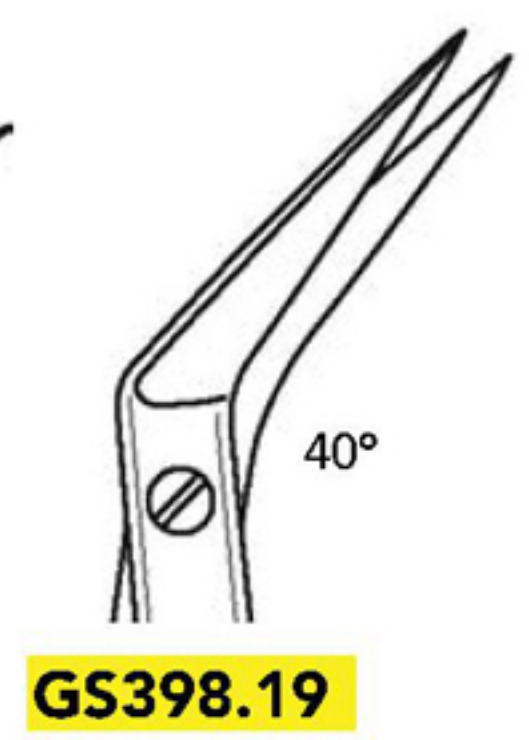
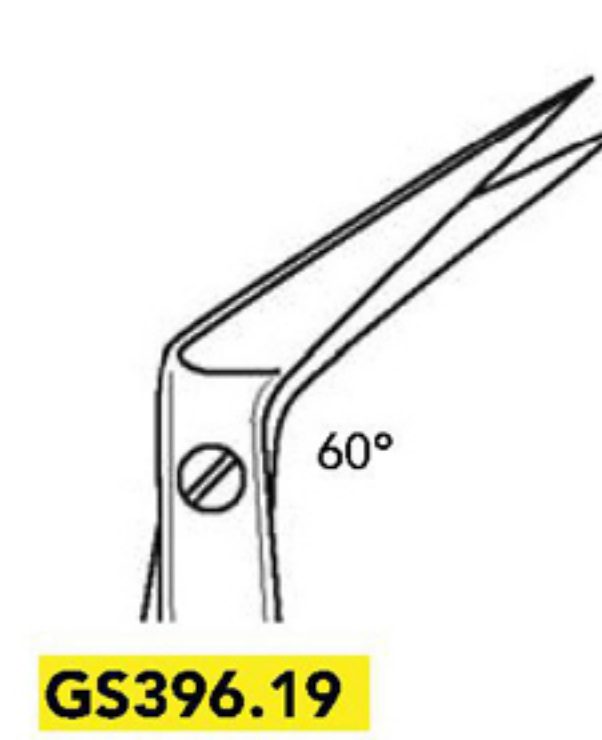

DEBAKEY  
16 cm/6¼"

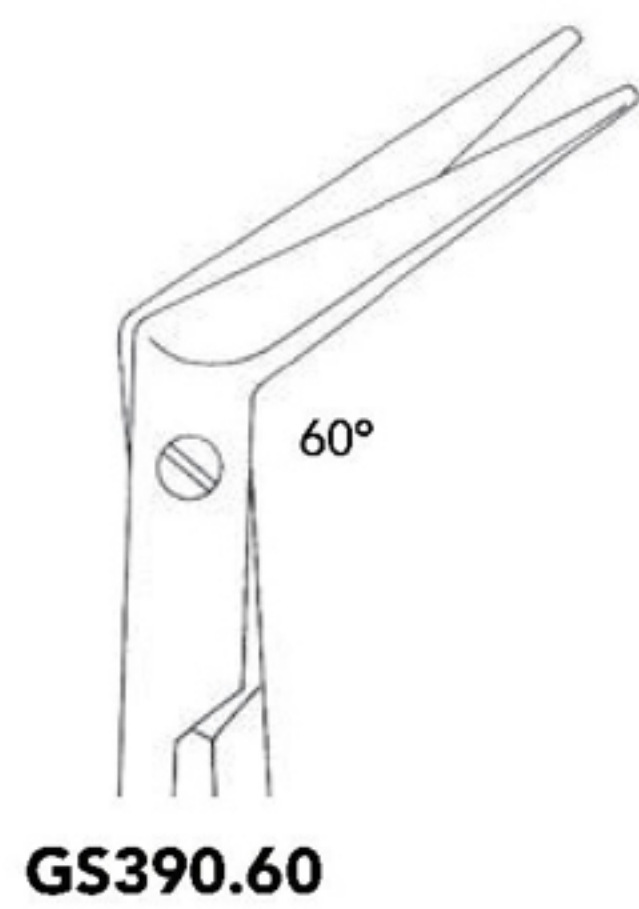
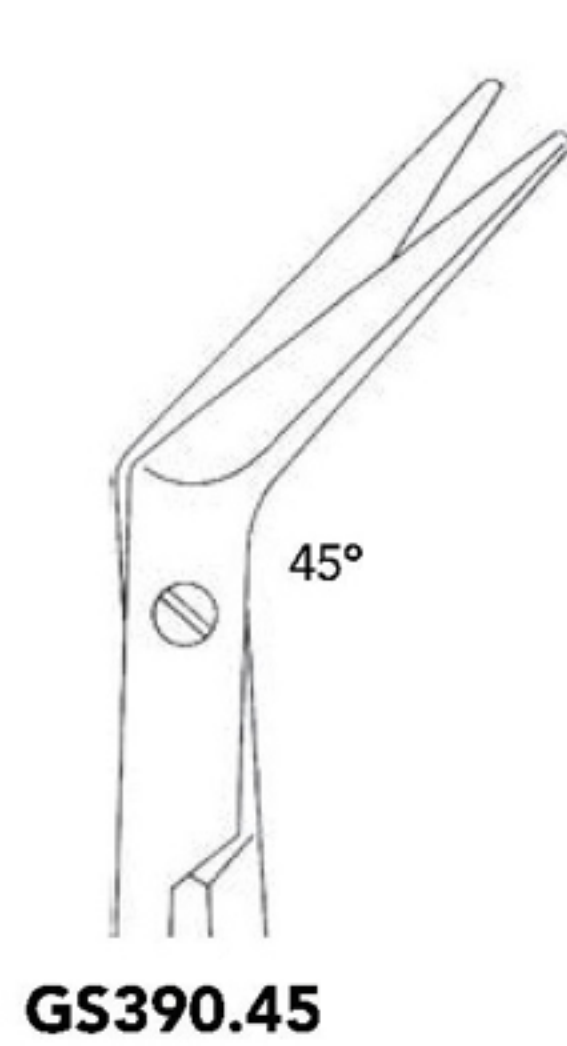
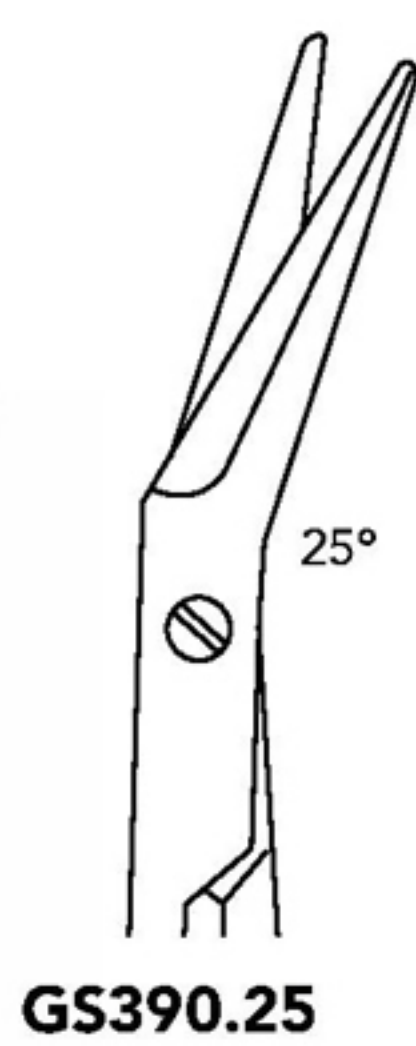

DEBAKEY

TC Edge

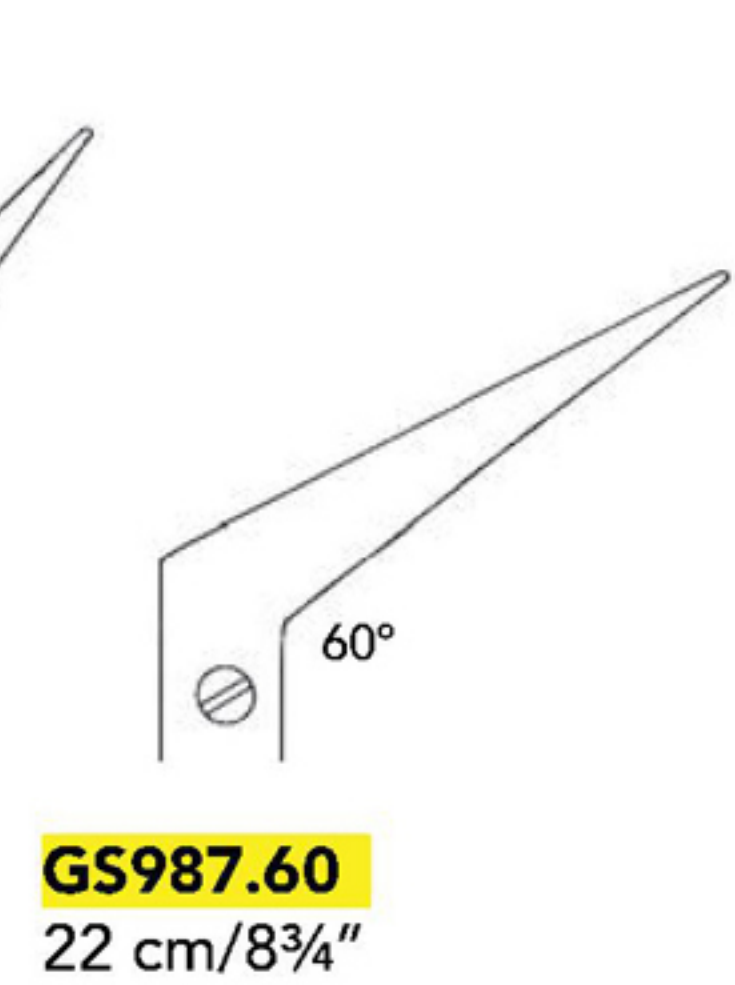
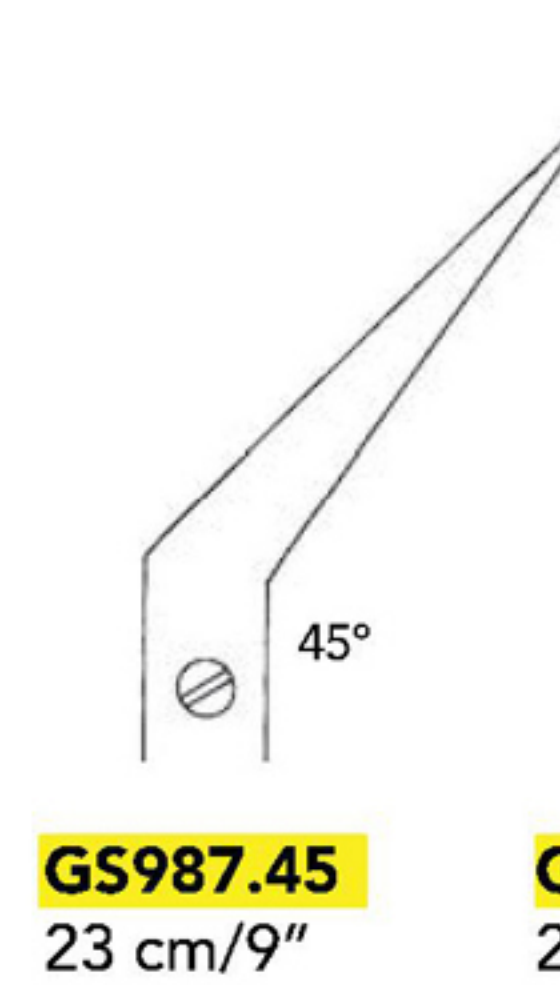
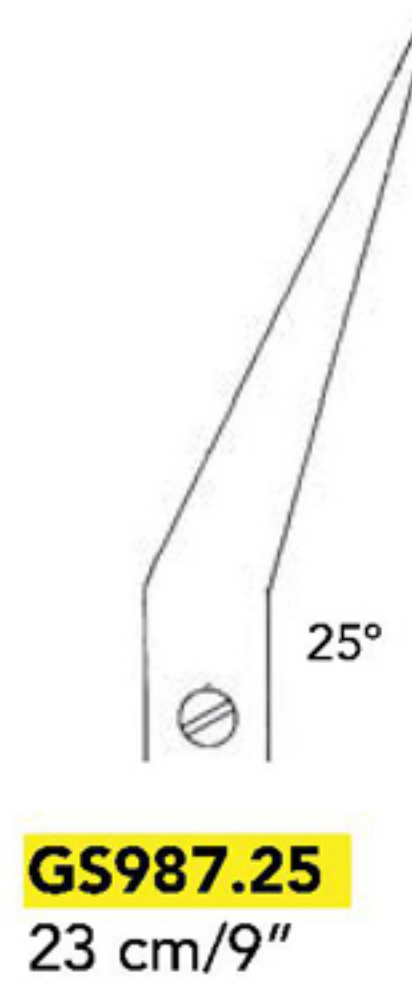
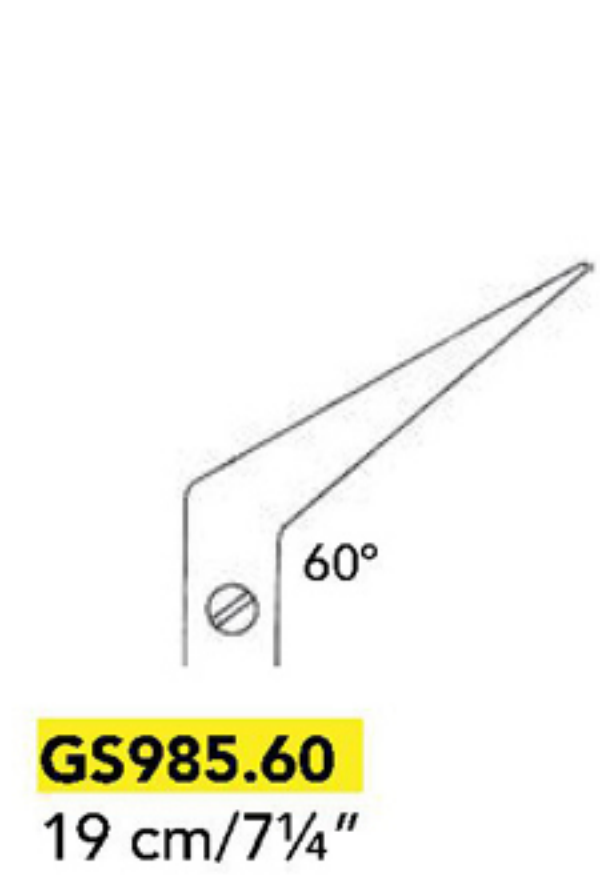
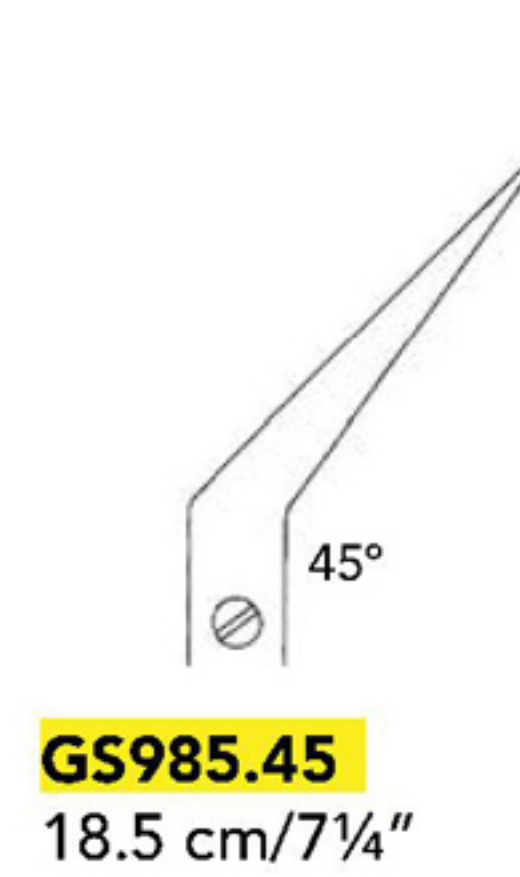
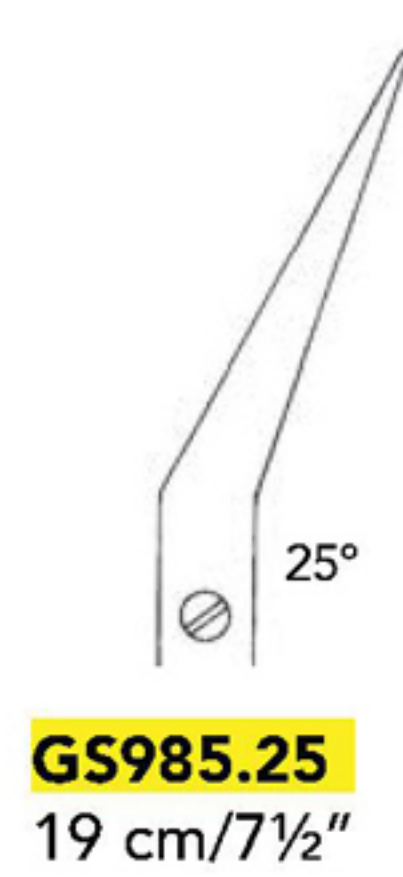



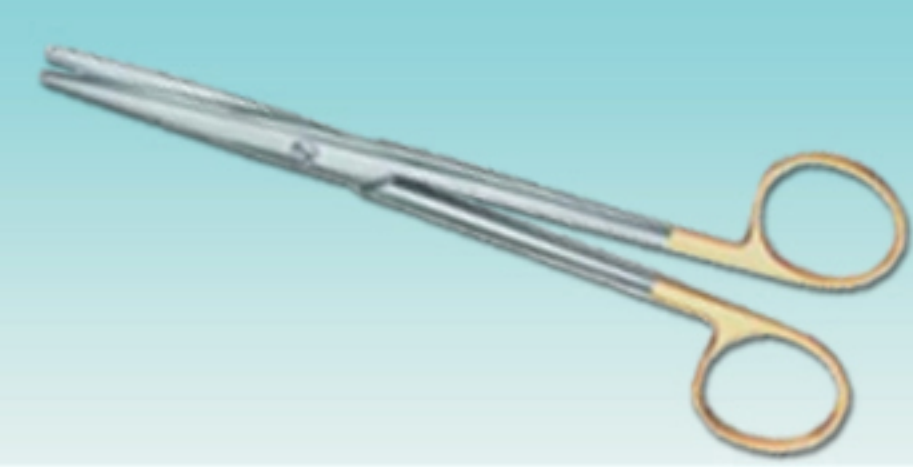

## Scissors (Nasal & Gum Scissors)

One serrated cutting edge

TC Edge

Nasal Scissors



HEYMANN  
**GS511.18**  
18 cm/7"

HEYMANN  
**GS513.18**  
18 cm/7"

COTTLE  
**GS509.16**  
15.5 cm/6"

COTTLE  
**GS505.16**  
16 cm/6¼"

CONVERSE 10.5 cm/4¼"	
Sharp	Blunt
<b>GS519.11</b>	<b>GS517.11</b>

One toothed cutting edge

TC Edge



GOLDMAN-FOX 13 cm/5¼"	
Straight	Curved
<b>GS566.13</b>	<b>GS567.13</b>

GOLDMAN-FOX 13 cm/5¼"	
Straight	Curved
<b>GS980.13</b>	<b>GS981.13</b>

WAGNER 12 cm/4¾"	
Straight	Curved
<b>GS570.12</b>	<b>GS571.12</b>

12 cm/4¾"		
Blunt/Blunt	Straight	Curved
Sharp/Blunt	<b>GS580.12</b>	<b>GS585.12</b>
Sharp/Sharp	<b>GS582.12</b>	<b>GS587.12</b>
	<b>GS584.12</b>	<b>GS589.12</b>



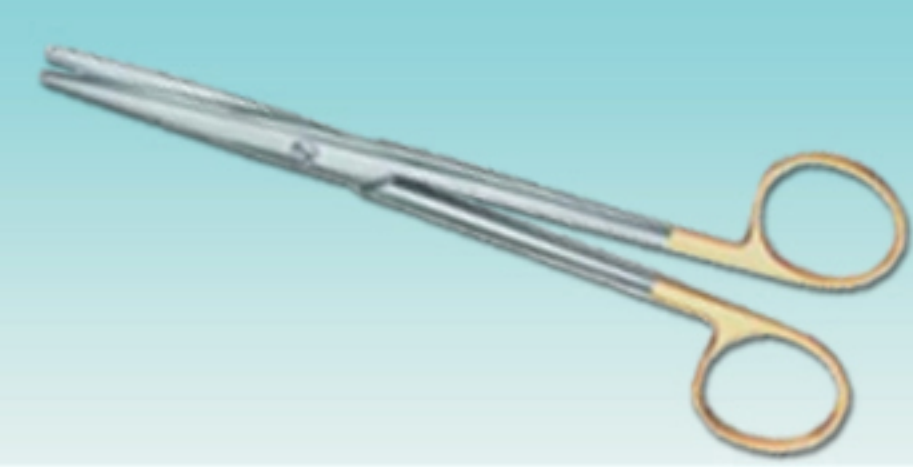

## Scissors (Gum & Iris Scissors)



Extra delicate

9 cm/3½"

Straight **GS618.08** Curved **GS619.08**



**GS633.11**  
11.5 cm/4½"



11.5 cm/4½"  
Straight **GS690.11** Curved **GS691.11**



IRIS **GS635.11**  
11.5 cm/4½"



TC Edge

IRIS **GS989.11**  
11.5 cm/4½"



IRIS

	Straight	Curved
9.0 cm/3½"	<b>GS620.09</b>	<b>GS621.09</b>
10.5 cm/3½"	<b>GS620.10</b>	<b>GS621.10</b>
11.5 cm/4½"	<b>GS620.11</b>	<b>GS621.11</b>
12.5 cm/5"	<b>GS620.12</b>	<b>GS621.12</b>



TC Edge

IRIS  
11.5 cm/4½"

Straight **GS982.11** Curved **GS983.11**



SuperCut

IRIS  
11.5 cm/4½"

Straight **GS672.11** Curved **GS673.11**



Delicate

11.5 cm/4½"

Straight **GS640.12** Curved **GS641.12**



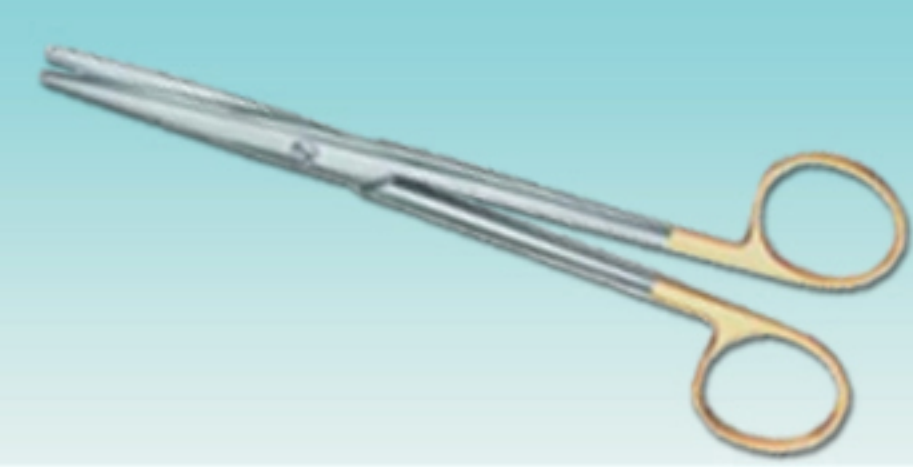

## Scissors (Iris & Strabismus Scissors)



GRAEFE  
**GS637.10**  
10 cm/4"

S-shape one toothed cutting edge



LA GRANGE  
**GS593.11**  
11.5 cm/4½"



Extra flat blades  
**GS622.10**  
10.5 cm/4¼"



Enucleation scissors

**GS705.11**  
11.5 cm/4½"

Sharp/Sharp



STEVENS  
11 cm/4¼"

Straight Curved  
**GS680.11** **GS681.11**

SuperCut

Sharp



STEVENS  
11 cm/4¼"

Straight Curved  
**GS674.11** **GS675.11**

Blunt/Blunt



STEVENS  
11 cm/4¼"

Straight Curved  
**GS682.11** **GS683.11**

SuperCut

Blunt/Blunt



STEVENS  
11 cm/4¼"

Straight Curved  
**GS676.11** **GS677.11**



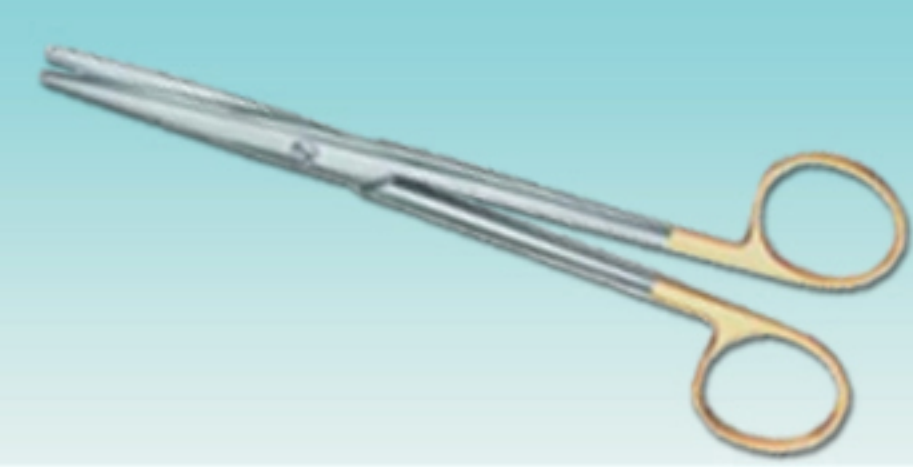

## Scissors (Gynecological & Episiotomy Scissors)

TC Edge



SIMS

	Straight	Curved
20 cm/8"	<b>GS200.20</b>	<b>GS203.20</b>
23 cm/9"	<b>GS200.23</b>	<b>GS203.23</b>



SIMS

	Straight	Curved
20 cm/8"	<b>GS976.20</b>	<b>GS977.20</b>
23 cm/9"	<b>GS976.23</b>	<b>GS977.23</b>



SIMS-SIEBOLD

**GS232.24**  
24 cm/9<sup>3</sup>/<sub>4</sub>"



SIMS-SIEBOLD

**GS233.24**  
24 cm/9<sup>3</sup>/<sub>4</sub>"



WERTHEIM

	Curved
20 cm/8"	<b>GS235.20</b>
23 cm/9"	<b>GS235.23</b>



DOYEN  
18 cm/7<sup>1</sup>/<sub>4</sub>"

	Straight	Curved
	<b>GS230.17</b>	<b>GS231.17</b>

One serrated cutting edge



WALDMANN  
**GS531.18**  
18 cm/7"



BRAUN-STADLER  
**GS535.14**  
14.5 cm/5<sup>3</sup>/<sub>4</sub>"



BRAUN-STADLER  
**GS537.22**  
20 cm



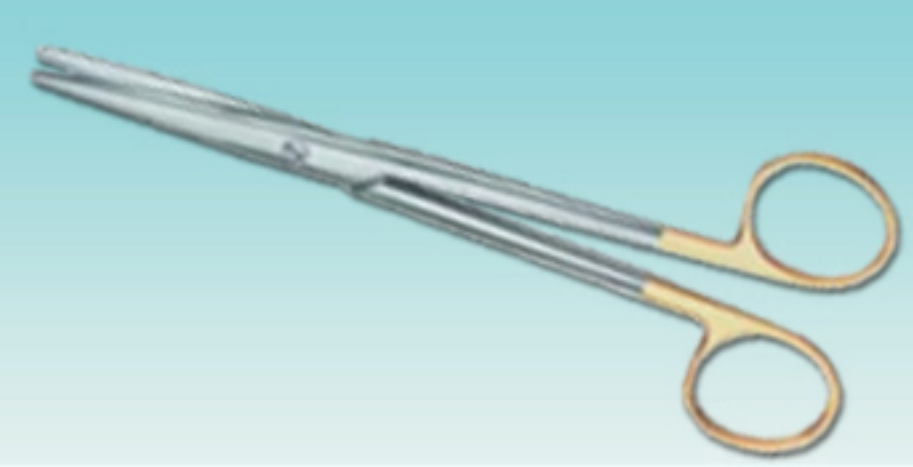

## Scissors (Umbilical & Stitch Scissors, Dissecting Scissors)

Umbilical scissors



Mod.USA  
**GS545.10**  
10.5 cm/4¼"

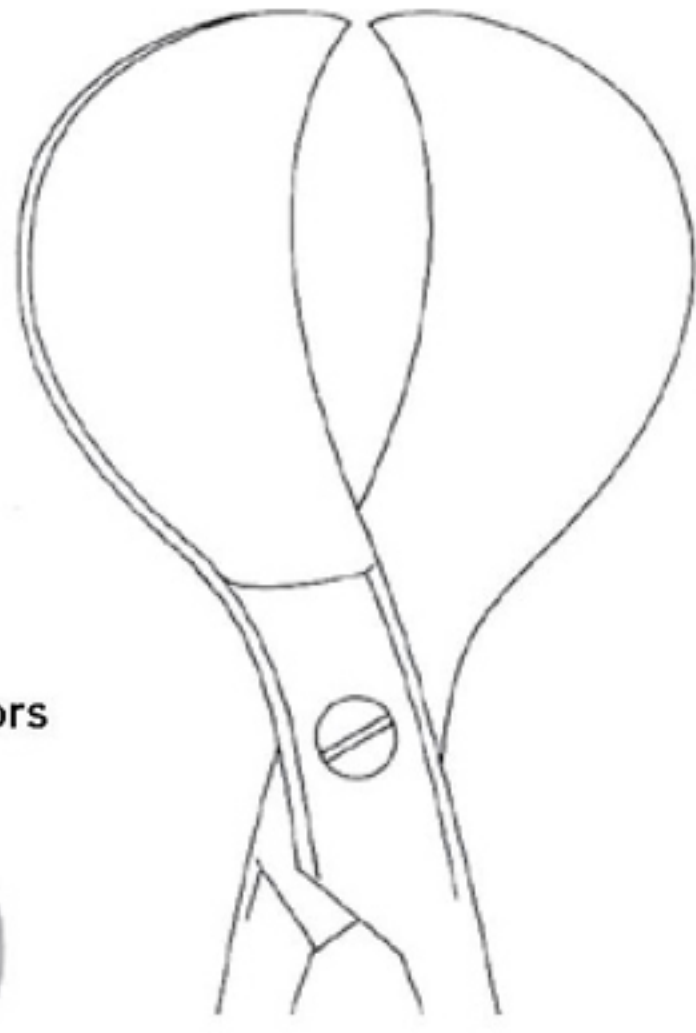

SCHUMACHER  
**GS547.16**  
15.5 cm/6"

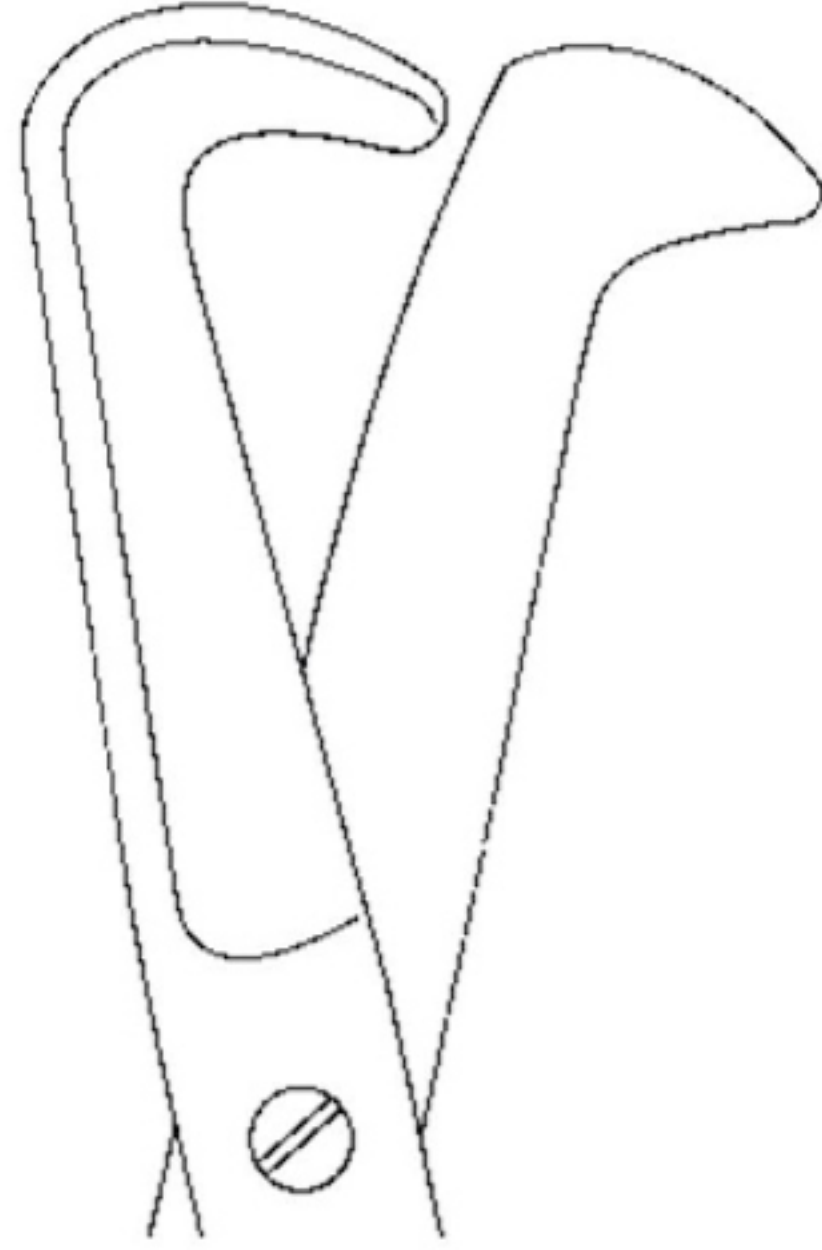

BUSCH  
**GS551.16**  
16 cm/6¼"



BUSCH  
**GS553.16**  
16 cm/6¼"

One toothed cutting edge

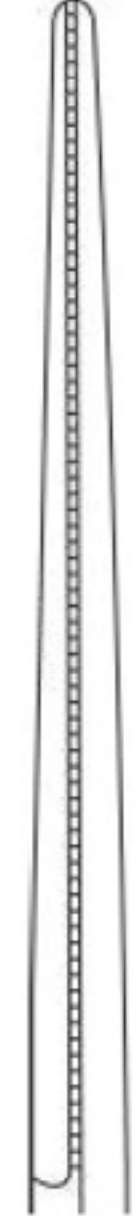

Stitch scissors



SPENCER  
**GS824.09**  
9 cm/3½"



SPENCER  
**GS826.13**  
13 cm/5"



LITTAUER  
**GS834.14**  
14 cm/5½"



FOMON  
**GS317.14**  
14.5 cm/5¾"

Dissecting scissors



RAGNELL  
**GS991.12**  
12.5 cm/5"

TC Edge



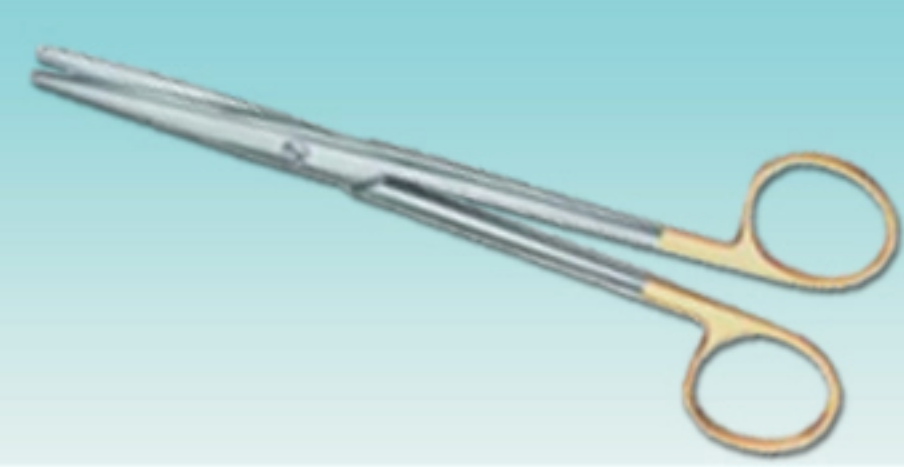

## Scissors (Enterotomy & Rectal Scissors)

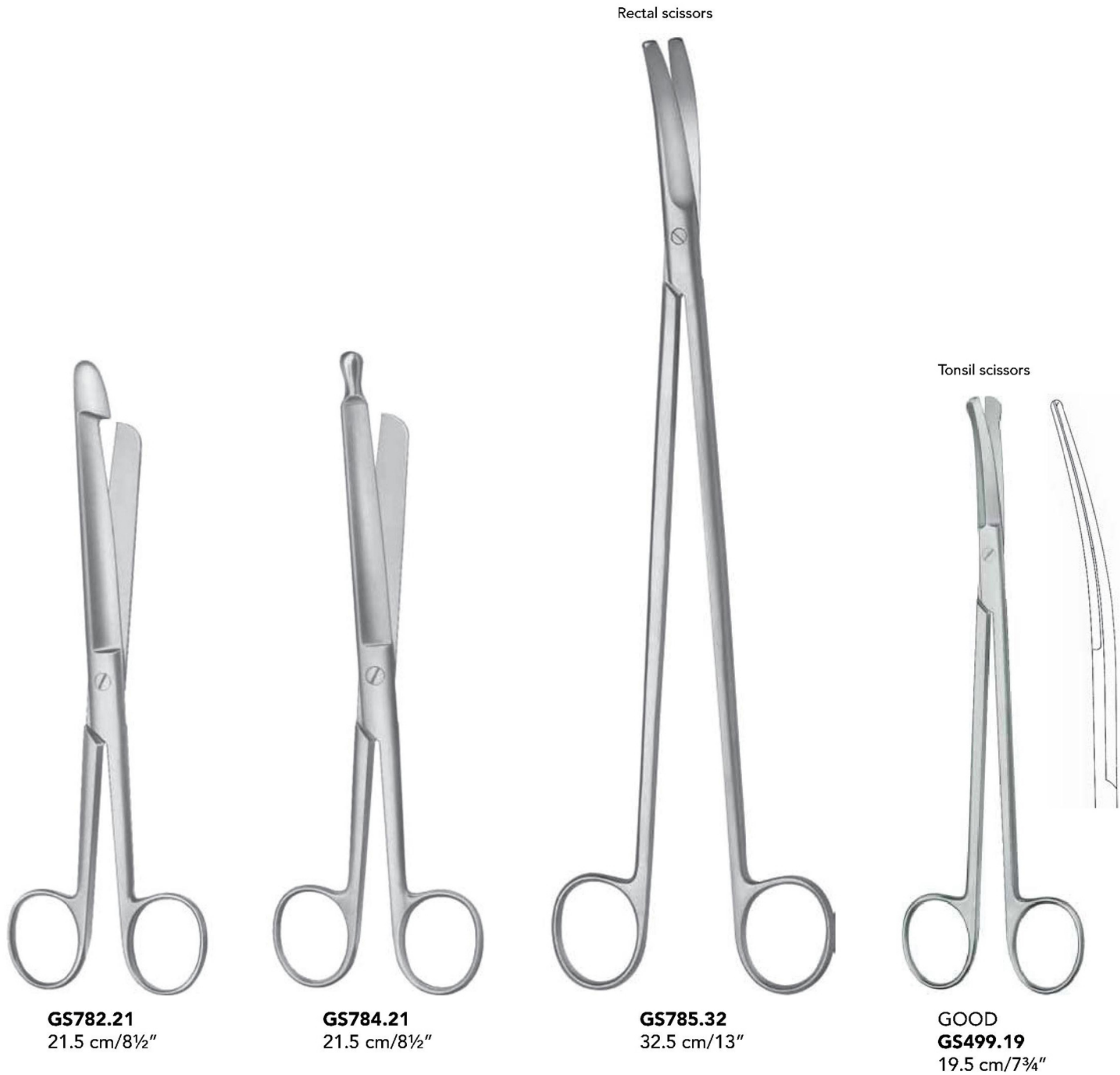



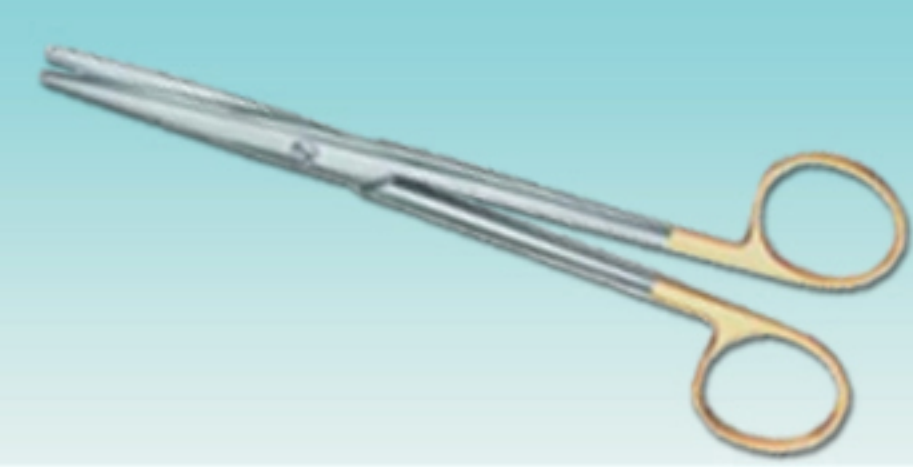

## Scissors (Tonsil & Gum Scissors, Wire Cutting Scissors)

	<b>TC Edge</b>	One toothed cutting edge	One toothed cutting edge	One toothed cutting edge
DEAN <b>GS495.17</b> 17.5 cm/7"	DEAN <b>GS994.17</b> 17.5 cm/7"	DEAN <b>GS497.17</b> 17.5 cm/7"	LOCKLIN 16 cm/5 1/4" <b>GS605.16</b> <b>GS999.16</b>	LOCKLIN 16 cm/5 1/4" <b>GS607.16</b> <b>GS997.16</b>

Wire cutting scissors		Wire cutting scissors	One toothed cutting edge
	<b>TC Edge</b>		
UNIVERSAL <b>GS865.12</b> 12 cm/4 3/4"	UNIVERSAL <b>GS995.12</b> 12 cm/4 3/4"	BEEBEE 10 cm/4" Straight   Curved <b>GS874.10</b> <b>GS875.10</b>	BEEBEE 12 cm/4 3/4" Straight   Curved <b>GS878.12</b> <b>GS879.12</b>



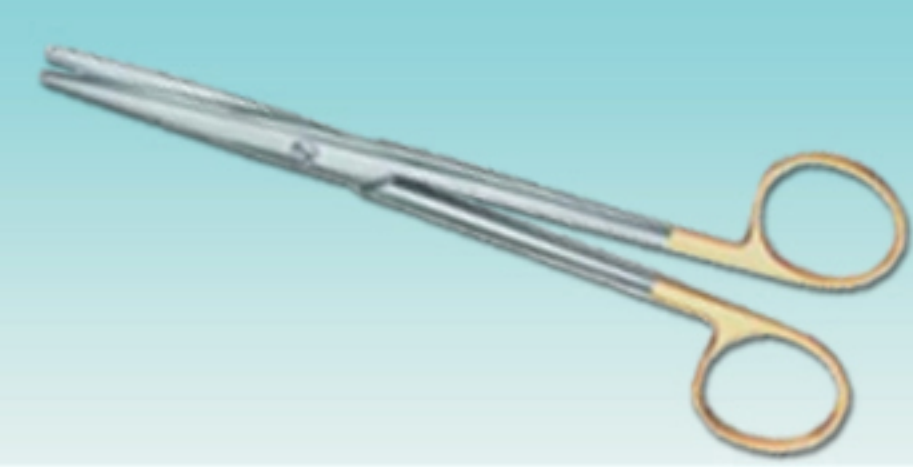

## Scissors (Dissecting & Face-Lift Scissors)

for Cleft palate



**SALYER**  
**GS784.09**  
9.5 cm/3¾"

for Cleft palate



**SALYER**  
**GS801.10**  
10 cm/3¾"

Both cutting  
edges serrated



**KAYE**  
**GS809.11**  
11 cm/4¼"

Sharp



**PECK-JOSEPH**  
14.5 cm/5¾"  
Straight **GS352.14** Curved **GS353.14**

Blunt



**PECK-JOSEPH**  
14.5 cm/5¾"  
Straight **GS354.14** Curved **GS355.14**

**TC Edge**

Toothed cutting edge

Toothed cutting edge

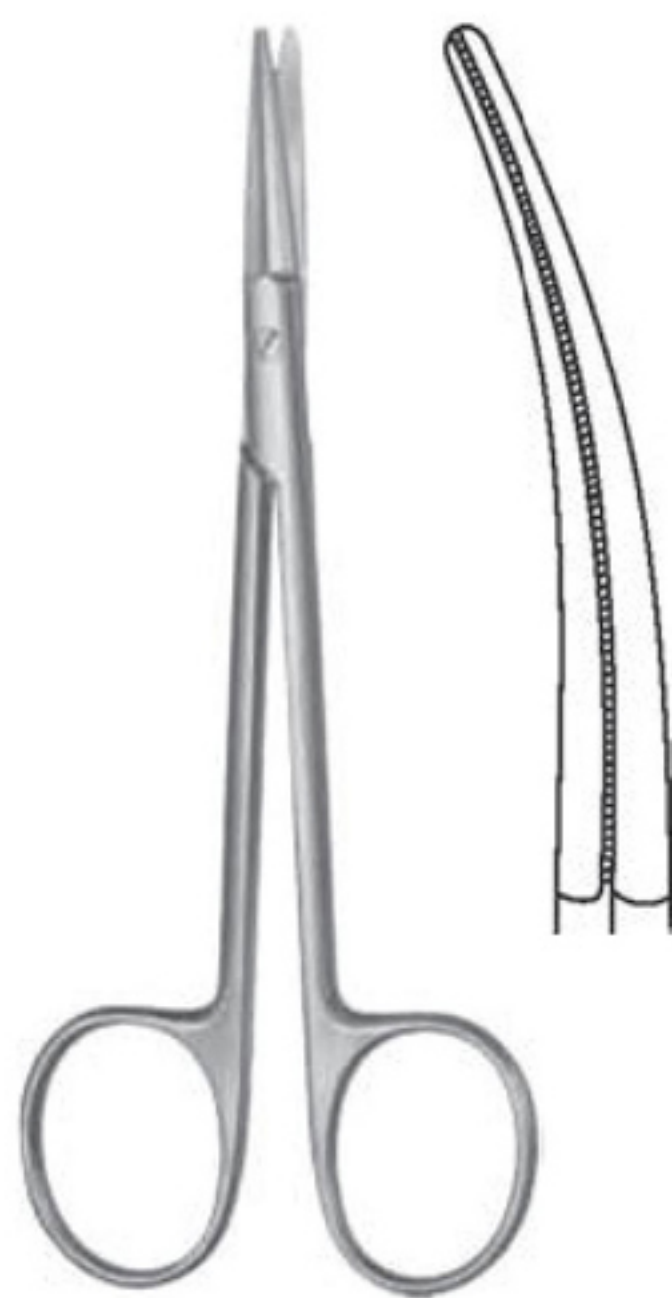

**GORNEY**

Straight Curved  
12.5 cm/5" **GS306.12**  
19.5 cm/7¾" **GS306.19** **GS307.19**  
17 cm/6¾" **GS308.17**

Toothed cutting edge



**GORNEY**

20 cm/8" **GS970.19**  
23 cm/9" **GS970.23**

**TC Edge**

Toothed cutting edge



**REES**

17 cm/7" **FL241.17**



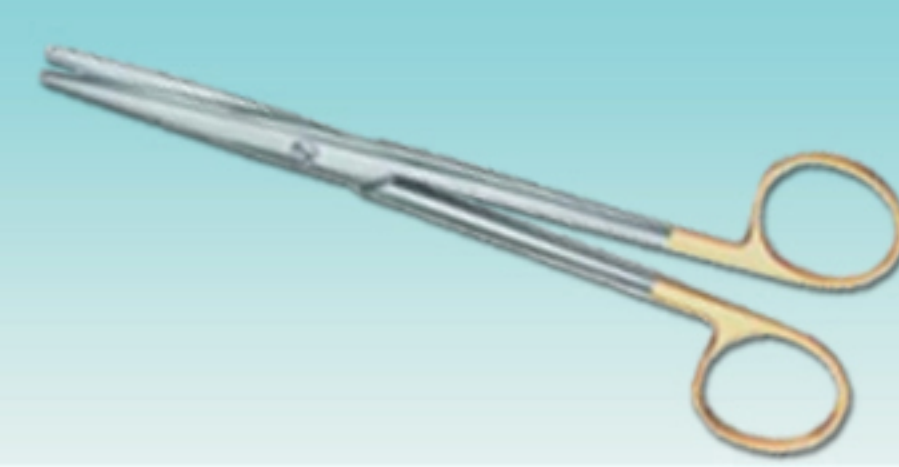

## Scissors (Face-Lift Scissors)

Toothed cutting edge



**GORNEY**

		TC	SuperCut
18 cm/7"	Straight	<b>FL110.18</b>	<b>FL120.18</b>
18 cm/7"	Curved	<b>FL111.18</b>	<b>FL121.18</b>
23 cm/9"	Straight	<b>FL110.23</b>	<b>FL120.23</b>
23 cm/9"	Curved	<b>FL111.23</b>	<b>FL121.23</b>

Toothed cutting edge

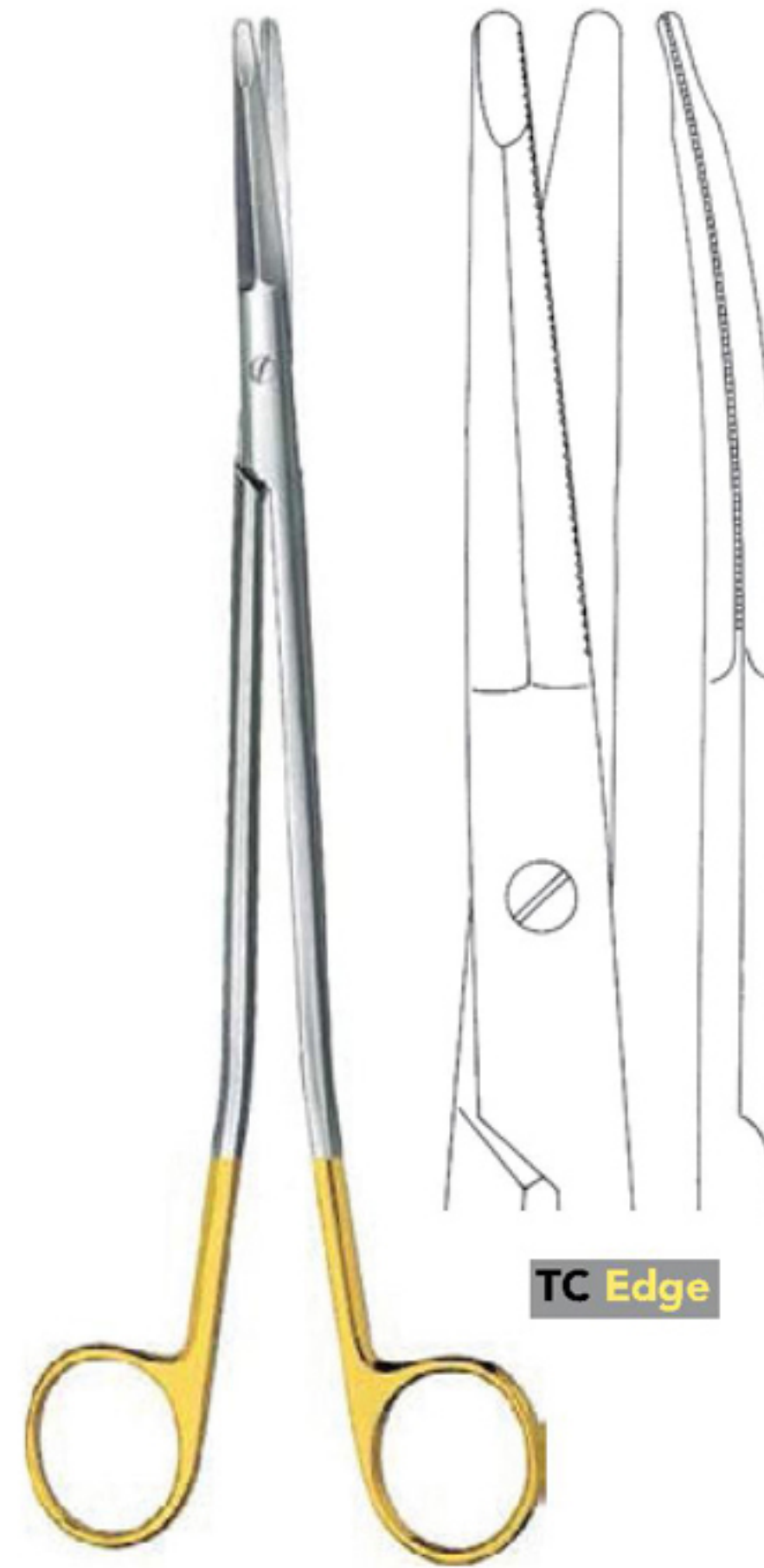

**FREEMAN-GORNEY**

		TC	SuperCut
Straight		<b>FL130.18</b>	<b>FL140.18</b>
Curved		<b>FL131.18</b>	<b>FL141.18</b>
Straight		<b>FL130.23</b>	<b>FL140.23</b>
Curved		<b>FL131.23</b>	<b>FL141.23</b>

Toothed cutting edge



**GREGORY  
FL501.14**  
14.5 cm/5¾"

Toothed cutting edge



**KAYE**

		TC	SuperCut
15 cm/6"		<b>FL211.15</b>	<b>FL221.15</b>
18 cm/7"		<b>FL211.18</b>	<b>FL221.18</b>
23 cm/9"		<b>FL211.23</b>	<b>FL221.23</b>

Toothed cutting edge



**FREEMAN-KAYE  
FL171.18**  
18 cm/7"

Toothed cutting edge



**STELLA-S  
FL505.18**  
18 cm/7"



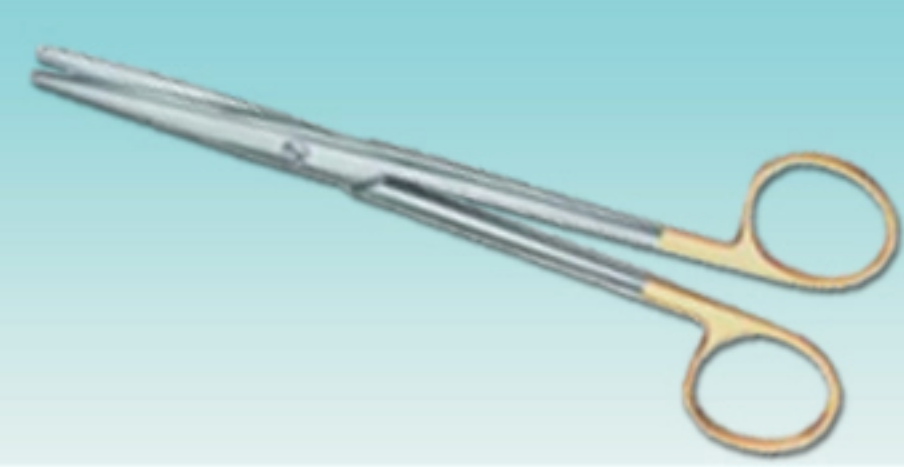

## Scissors (Micro Scissors)



Streamlined

10 mm



Adventitia  
Blades

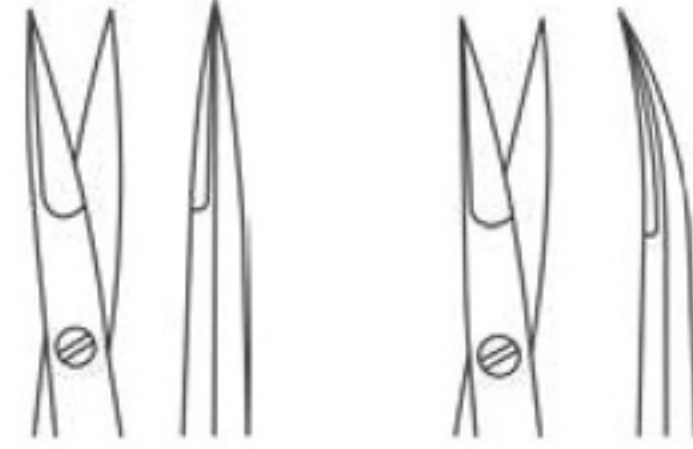

Dissection  
Blades



Adventitia  
Serrated Blades

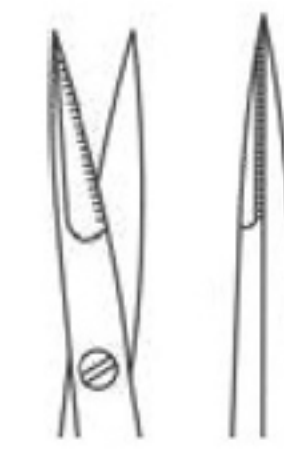

Dissection  
Serrated Blades

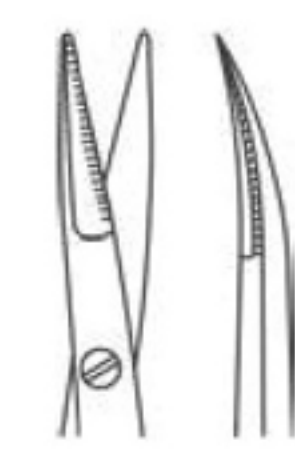

15 cm/6"  
18 cm/7"  
21 cm/8¼"  
23 cm/9"

**MS712.15**  
**MS712.18**  
**MS712.21**  
**MS712.23**

**MS713.15**  
**MS713.18**  
**MS713.21**  
**MS713.23**

**MS713.19**

**MS712.19**

**MS713.20**

10 mm



Adventitia  
Blades



Dissection  
Blades



Adventitia  
Serrated Blades

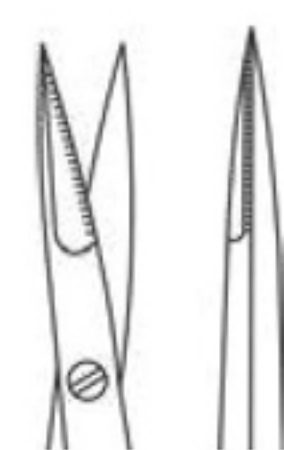

Dissection  
Serrated Blades

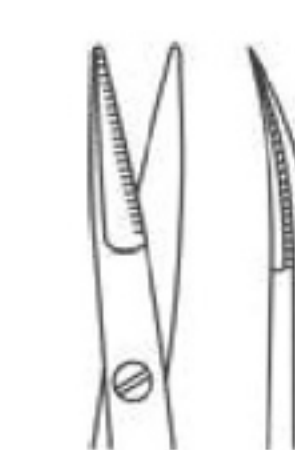

15 cm/6"  
18 cm/7"  
21 cm/8¼"  
23 cm/9"

**MS710.15**  
**MS710.18**  
**MS710.21**  
**MS710.23**

**MS711.15**  
**MS711.18**  
**MS711.21**  
**MS711.23**

**MS711.19**

**MS710.19**

**MS711.20**



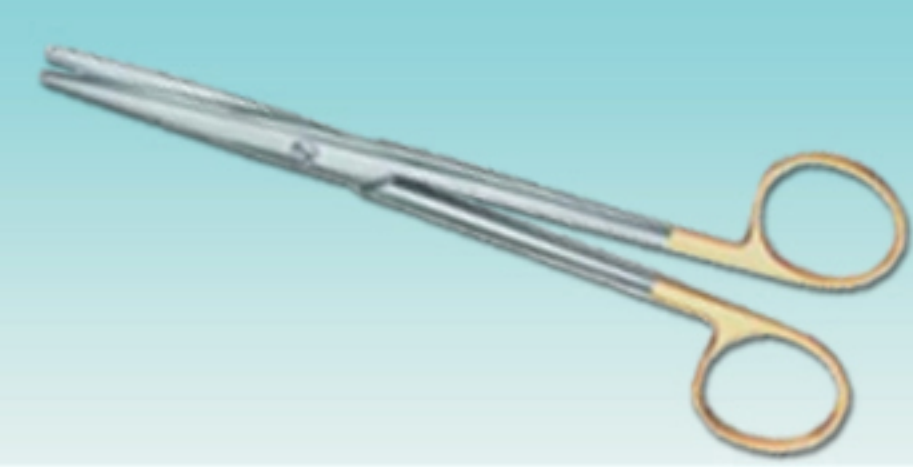

## Scissors (Micro Scissors)



Streamlined

10 mm



25°

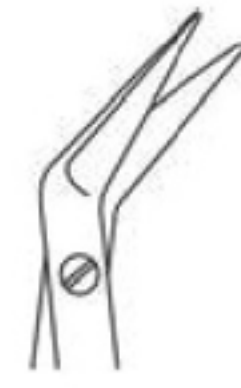

45°



60°



90°



125°

18 cm/7"	<b>MS400.25</b>	<b>MS400.45</b>	<b>MS400.60</b>	<b>MS400.90</b>	<b>MS401.00</b>
21 cm/8¼"	<b>MS384.25</b>	<b>MS384.45</b>	<b>MS384.60</b>	<b>MS384.90</b>	<b>MS385.00</b>
23 cm/9"	<b>MS398.25</b>	<b>MS398.45</b>	<b>MS398.60</b>	<b>MS398.90</b>	<b>MS399.00</b>

7 mm



25°



45°



60°



90°



125°

18 cm/7"	<b>MS402.25</b>	<b>MS402.45</b>	<b>MS402.60</b>	<b>MS402.90</b>	<b>MS403.00</b>
----------	-----------------	-----------------	-----------------	-----------------	-----------------

10 mm



25°



45°



60°



90°



125°

18 cm/7"	<b>MS412.25</b>	<b>MS412.45</b>	<b>MS412.60</b>	<b>MS412.90</b>	<b>MS413.00</b>
21 cm/8¼"	<b>MS436.25</b>	<b>MS436.45</b>	<b>MS436.60</b>	<b>MS436.90</b>	<b>MS437.00</b>
23 cm/9"	<b>MS438.25</b>	<b>MS438.45</b>	<b>MS438.60</b>	<b>MS438.90</b>	<b>MS439.00</b>

7 mm



25°



45°



60°



90°



125°

18 cm/7"	<b>MS414.25</b>	<b>MS414.45</b>	<b>MS414.60</b>	<b>MS414.90</b>	<b>MS415.00</b>
----------	-----------------	-----------------	-----------------	-----------------	-----------------



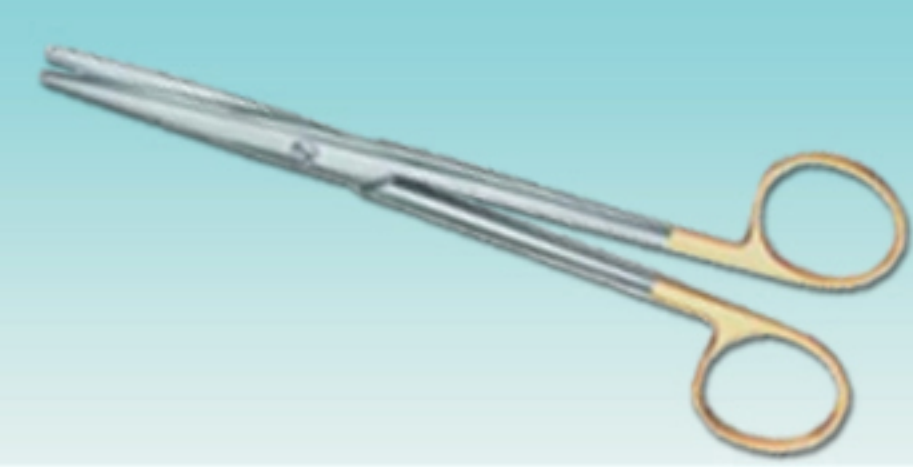

## Scissors (Micro Scissors)



15 cm/6"

Adventitia  
Blades

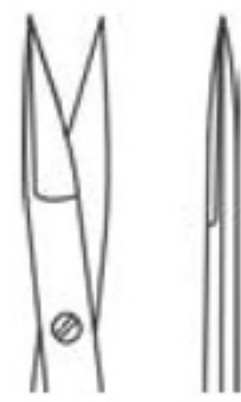

**MS700.00**

Dissection  
Blades



**MS701.00**

9 mm

Adventitia  
Serrated Blades



**MS700.01**

Dissection  
Serrated Blades



**MS701.01**

14 mm

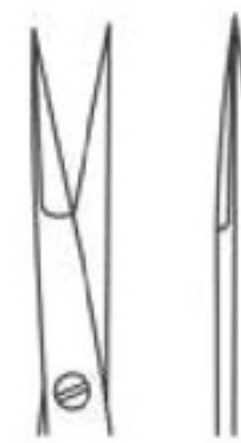

**MS700.04**



**MS701.04**



**MS700.05**

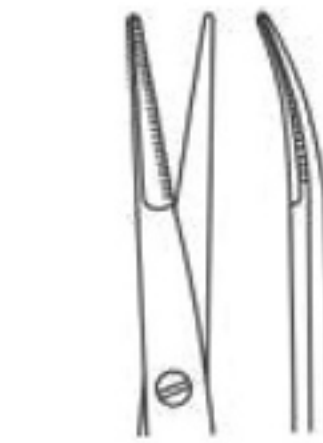

**MS701.05**

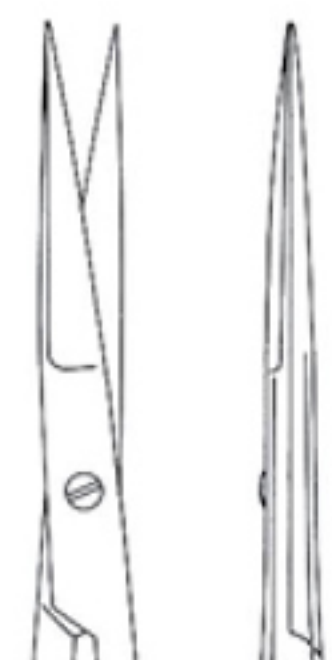

**MS740.11**



**WESTCOTT**  
11.5 cm/4½"

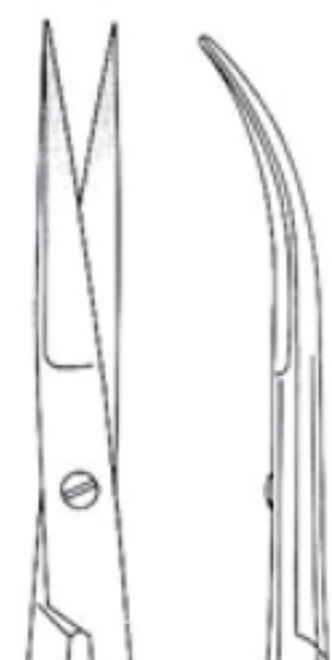

**MS741.11**

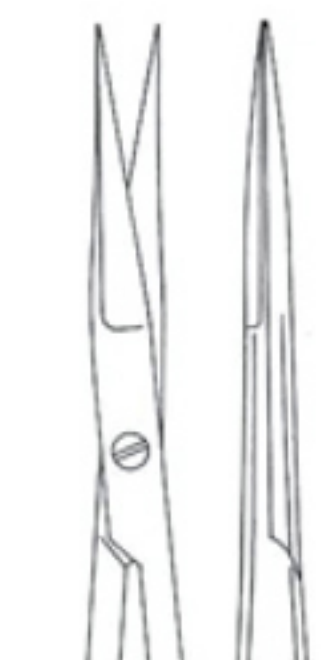

**MS756.12**



12 cm/4¾"



**MS757.12**

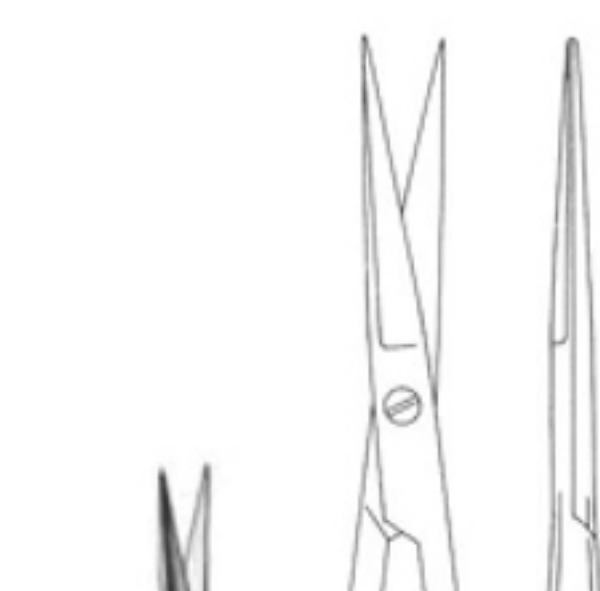

**MS760.09**



10 cm/4"



**MS761.09**



10 cm/4"



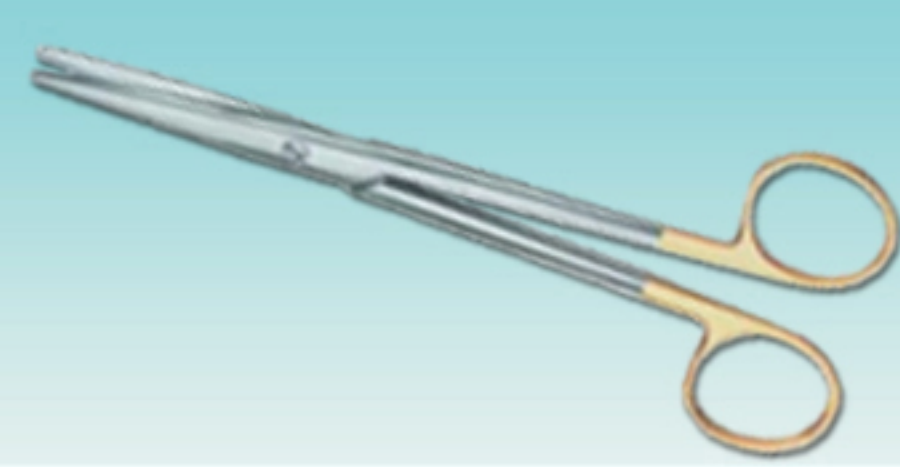

## Scissors (Micro Scissors)

Vein scissors



VANNAS  
12 cm/4 3/4"

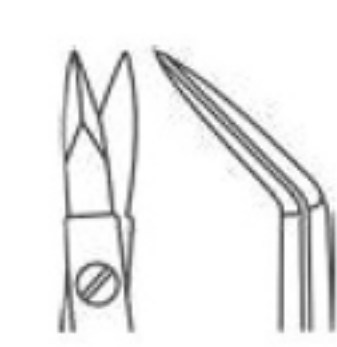

MS850.01A

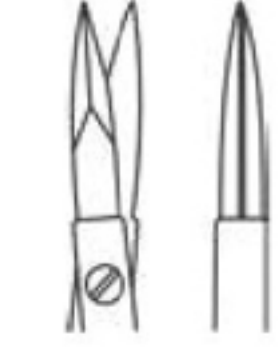

MS850.02A

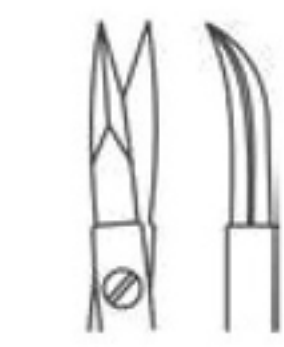

MS850.03



BIEMER  
GS758.12  
12 cm/4 3/4"

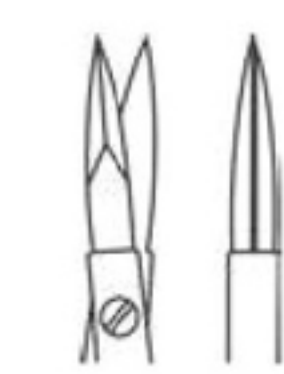

MS850.04A



MS850.05



VANNAS  
16 cm/6 1/4"



MILLESi  
16 cm/6 1/4"

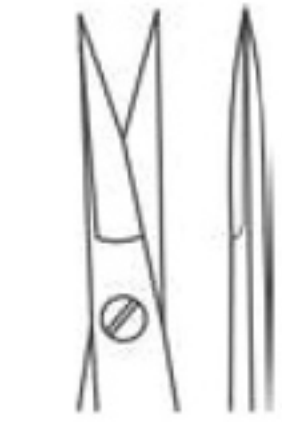

MS850.10A

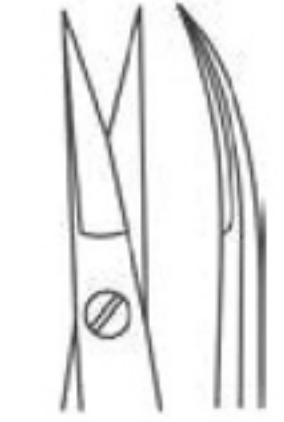

MS850.11

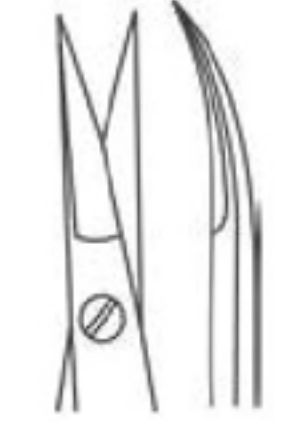

MS850.15A



JACOBSON  
18.5 cm/7 1/4"



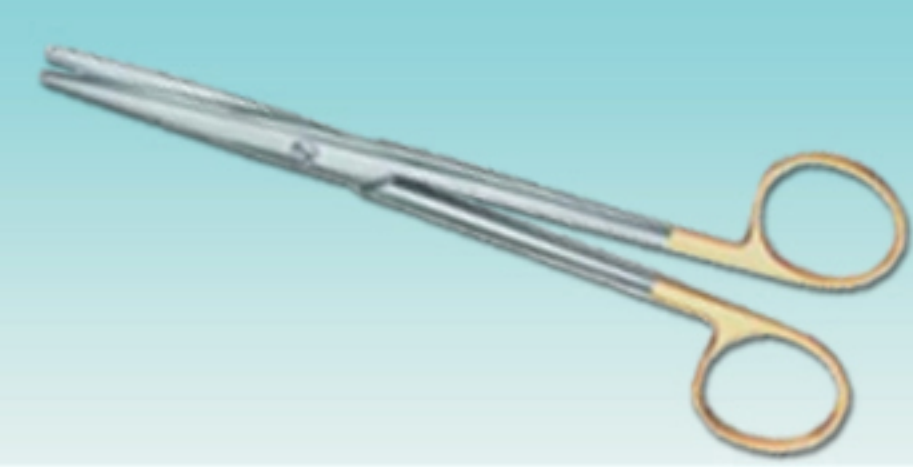

## Scissors (Micro Scissors - Bayonet Shape)

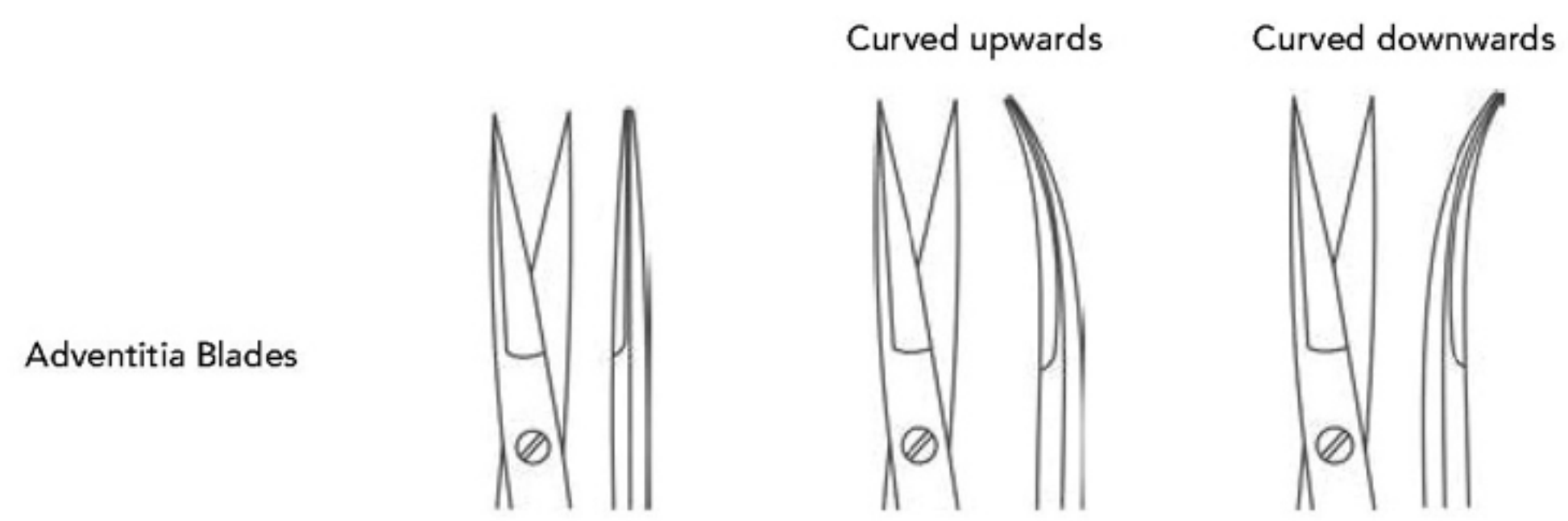

16 cm/6¼"  
20 cm/8"  
22.5 cm/9"  
24 cm

**MS850.16**  
**MS850.20A**  
**MS850.22**

**MS851.16**  
**MS851.20**  
**MS851.22**  
**MS850.24**

**MS853.20**



YASARGIL

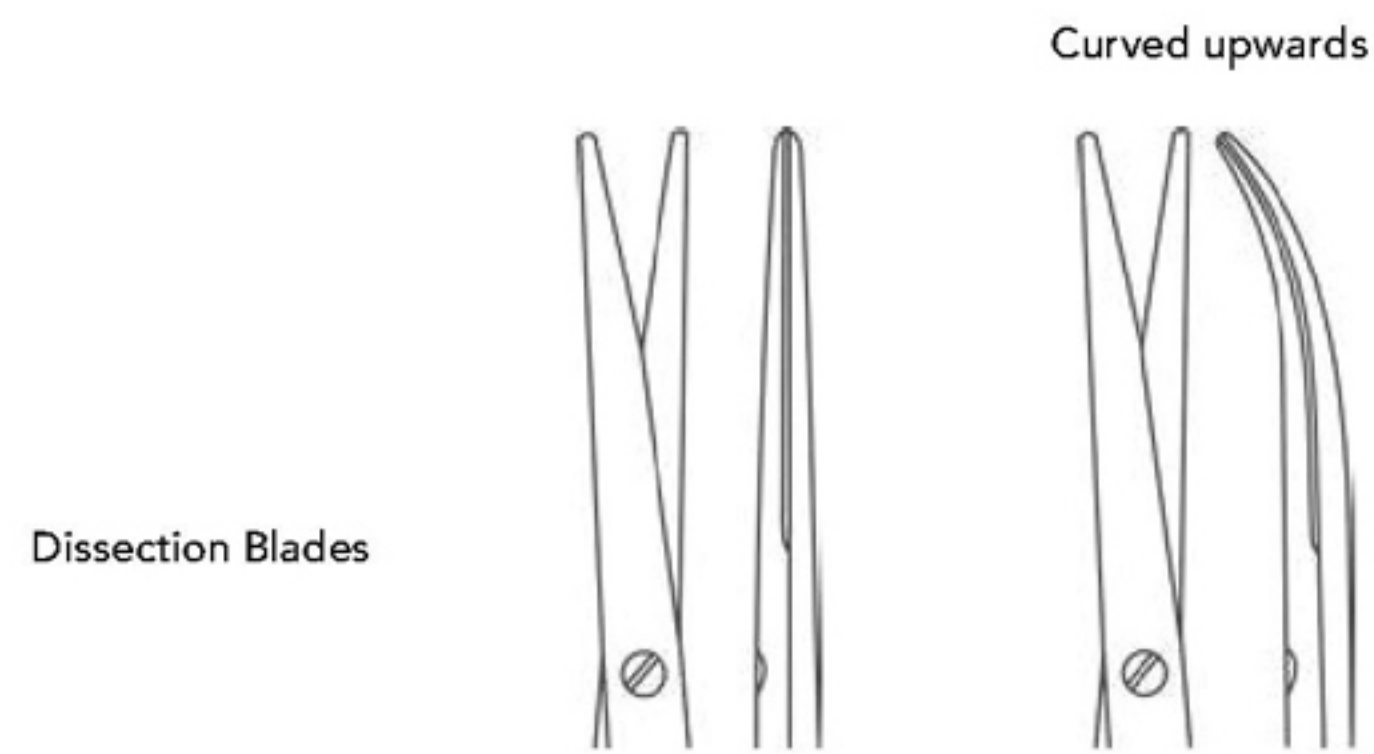

20 cm/8"  
22.5 cm/9"

**MS854.20A**  
**MS854.22**

**MS855.20A**  
**MS855.22A**